

LAUNDRIES
HALLWAY AND SHOE CABINETS

PRICE LIST - OCTOBER 2024

B03

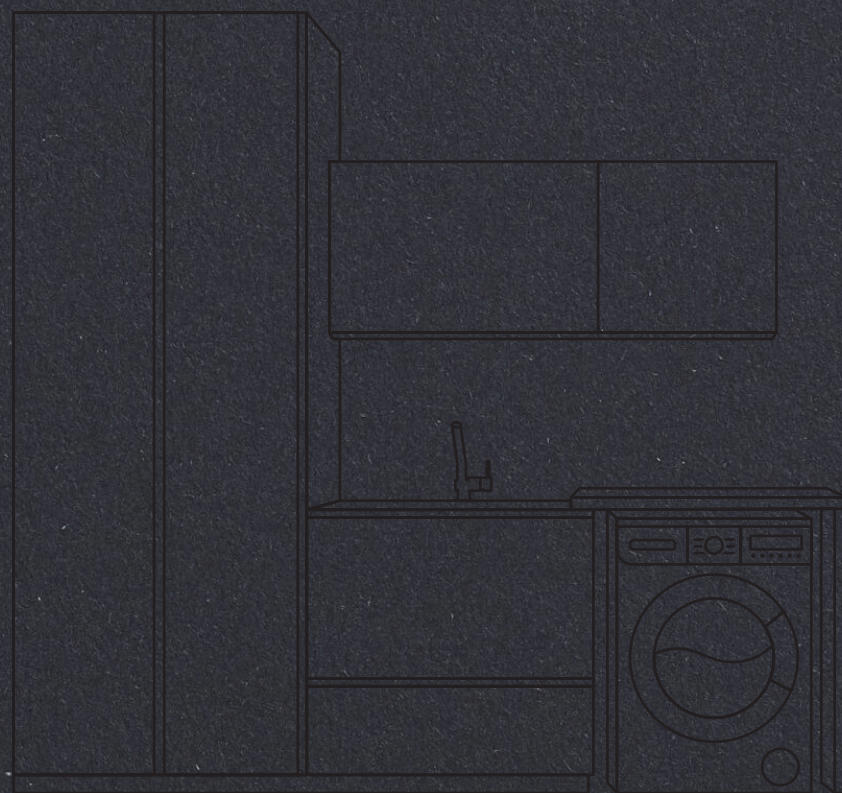

 **BIREX**

LAVANDERIE LAUNDRIES	P. 3
• IDROBOX	P. 3
• TOP	P. 113
• LAVATOI E MISCELATORI Washbasins and mixer taps	P. 135
INGRESSI HALLWAY CABINETS	P. 143
• GOLLA UP	P. 145
• SKAP	P. 193
SCARPIERE SHOE CABINETS	P. 203
• GOLLA UP	P. 204
• HOSOI	P. 214
• LINEAR	P. 220
• MINIMA	P. 225
• WELCOME	P. 234
ACCESSORI ACCESSORIES	P. 239
CONDIZIONI GENERALI DI VENDITA GENERAL SALES CONDITIONS	P. 255

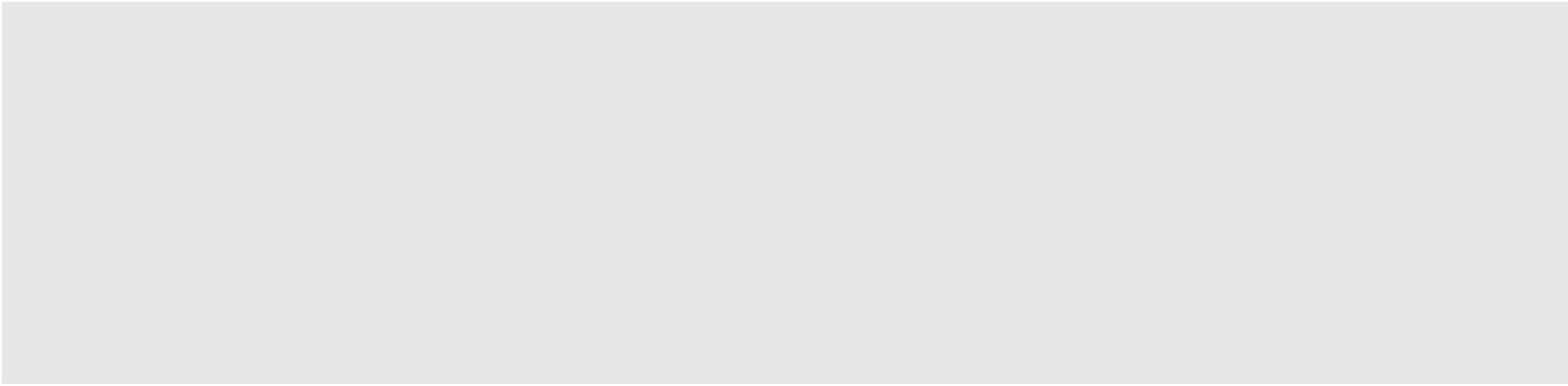

IDROBOX

ACCESSORI
ACCESSORIES

SCARPIERE
SHOE CABINETS

INGRESSI
HALLWAY CABINETS

IDROBOX TOP E LAVATOI
IDROBOX TOPS AND WASHBASINS

IDROBOX ATTREZZATURA
IDROBOX EQUIPMENT

IDROBOX COLONNE E PENSILI
IDROBOX TALL AND WALL UNITS

IDROBOX BASI
IDROBOX BASE UNITS

LACCATI OPACHI | MATT LACQUERS

9003 Bianco	9010 Panna	9001 Crema	1013 Fior di loto	9002 Ghiaccio	100 Sabbia	63 Tortora	68 Grigio perla
71 Light grey	7044 Grigio seta	62 Canapa	61 Corda	72 Dark grey	7039 Grigio aston	101 Giallo senape	173 Bruciato
3003 Rosso	3005 Rosso bordeaux	102 Rosa cipria	74 Terracotta	73 Moka	190 Verde pallido	103 Verde malva	104 Turchese
105 Oceano	106 Blu cobalto	246 Grigio Garda	107 Celeste	76 Carta da zucchero	7031 Grigio blu	7016 Grigio antracite	9017 Nero
Titanio	Nichel	Piombo					

MATERICI | TEXTURED FINISHES

Bianco	Quarzo	Sabbia	Avana	Perla	Argilla	Rovere virginia Virginia oak	Noce alabama Alabama walnut

METALLI | METALS

Rovere termotrattato Heat-treated oak	Bianco White	Nero Black	Titanio Titanium

SPECCHI | MIRRORS

Specchio Mirror

La riproduzione dei colori su carta può risultare alterata rispetto agli originali, pertanto queste tinte sono da considerarsi indicative. Laccato a campione/RAL con maggiorazione del 20%.
Finitura materico sp. 4 cm disponibile solo nelle varianti Avana, Quarzo, Noce alabama, Rovere termotrattato, Perla, Argilla.

The reproduction of the colours on paper may be different compared to the original ones, therefore these shades should be considered as representative only. 20% surcharge for custom colour/RALs.
Th 4 cm textured finish available only in Avana, Quarzo, Alabama Walnut, heat-treated Oak, Perla, Argilla.

CARATTERISTICHE TECNICHE

Technical features

IDROBOX

SCocca in pannelli di particelle di legno certificati CARB-2 sp. 18 mm e schiene sp. 8 mm
STRUCTURE made with CARB-2-certified 18 mm thick particleboard panels and 8 mm thick backs

ATTACCAGLIE regolabili con sistema antiganciamento
adjustable FASTENERS with mechanism to prevent accidental release

CERNIERE in acciaio brunito con chiusura ammortizzata integrata a scomparsa Salice
Salice HINGES with built-in concealed soft-close mechanism

FIANCO finitura materico avana di serie per basi e colonne. Disponibile in finitura come anta con maggiorazione (pagine 17-18)

standard SIDE in Avana textured finish. Available in the same finish as the front with a surcharge (pages 17-18)

SPALLA DI FINITURA pannello optional in particelle di legno certificati CARB-2 sp. 22 mm

optional FINISHING SIDE PANEL made with CARB-2-certified 22 mm thick particleboard

GUIDE ad estrazione totale Hettich con chiusura ammortizzata

Hettich RUNNERS with full pull-out and soft-close

SPONDE metalliche Hettich verniciate antracite
metal Hettich SIDEBARDS painted in Antracite

MANIGLIA in alluminio finitura metallo
aluminium HANDLE in metal finish

FRONTALI in pannelli di particelle di legno certificati CARB-2 sp. 18 mm
FRONTS made with 18 mm th CARB-2-certified particleboard panels

RIPIANI INTERNI in pannelli di particelle di legno certificati CARB-2 sp. 18 mm
INTERNAL SHELVES made with CARB-2-certified 18 mm thick particleboard panels

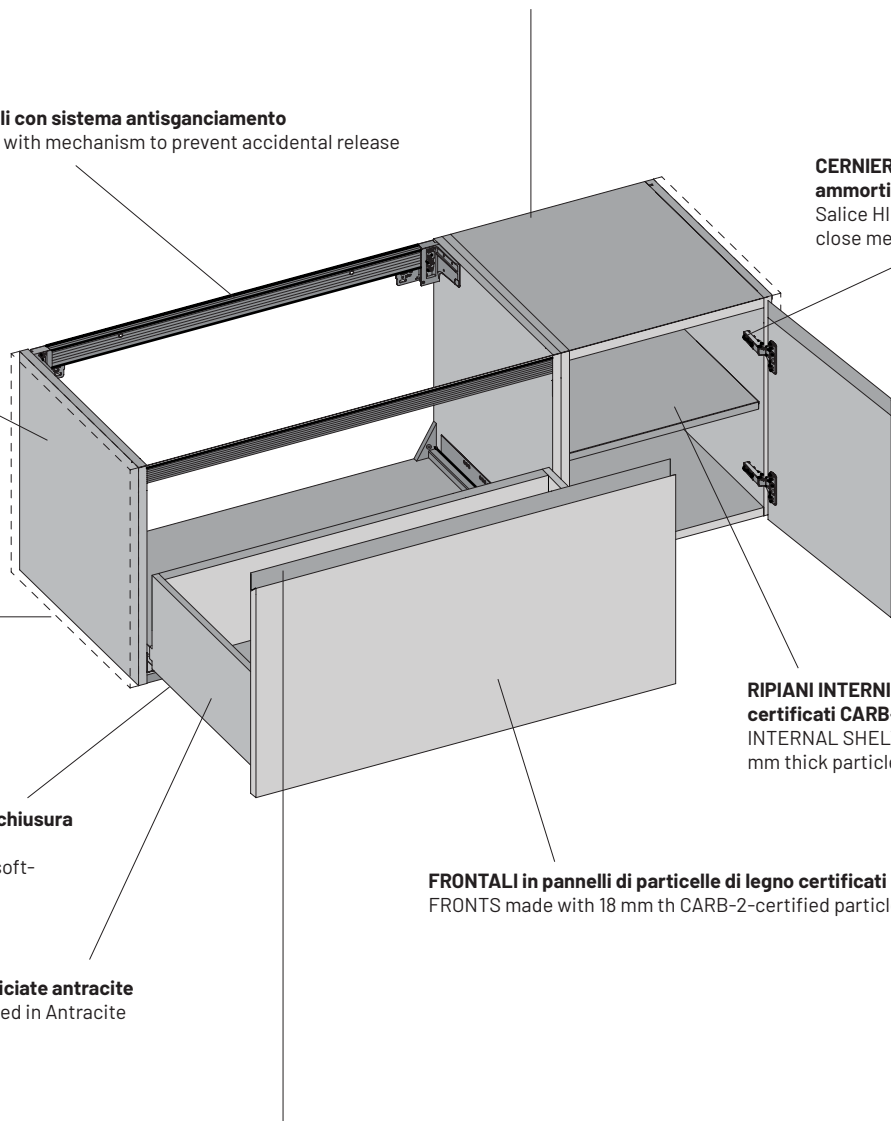

IDROBOX BASI
IDROBOX BASE UNITS

IDROBOX COLONNE E PENSILI
IDROBOX TALL AND WALL UNITS

IDROBOX ATTREZZATURA
IDROBOX EQUIPMENT

IDROBOX TOP E LAVATOI
IDROBOX TOPS AND WASHBASINS

INGRESSI
HALLWAY CABINETS

SCARPIERE
SHOE CABINETS

ACCESSORI
ACCESSORIES

SCOCCH STRUCTURES

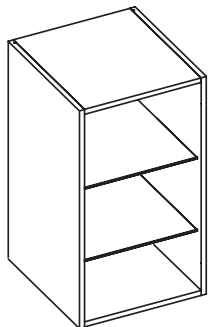

FIANCHI, COPERCHIO E FONDO: pannelli di particelle di legno certificati CARB-02 sp. 18 mm rivestiti con nobilitazione melaminica; bordatura poliuretana idrorepellente.

SIDES, TOP AND BOTTOM: CARB-02-certified 18 mm thick particleboard panels which have a melamine coating and water-repellent polyurethane edging.

SCHIENE: pannelli di particelle di legno certificati CARB-02 sp. 8 mm con nobilitazione melaminica.

BACKS: CARB-02-certified 8 mm thick particleboard panels with melamine coating.

FINITURA FRONTALE FRONT FINISH	FINITURA SCOCCA BASI, COLONNE, ELEMENTI SOPRALZO BASE, TALL AND TOP UNITS STRUCTURE FINISH	FINITURA SCOCCA PENSILI WALL UNITS STRUCTURE FINISH
<p>MATERICO TEXTURED FINISH</p>	<ul style="list-style-type: none"> • Schiena: materico avana Coperchio, fondo, fianchi: materico avana (due lati) • Back: Avana textured finish Top, bottom, sides: Avana textured finish (two sides) 	<ul style="list-style-type: none"> • Schiena: materico avana Coperchio, fondo, fianchi: materico come il frontale (due lati) • Back: Avana textured finish Top, bottom, sides: textured finish like the front (two sides)
<p>LACCATO OPACO MATT LACQUER</p>	<ul style="list-style-type: none"> • Schiena: materico avana Coperchio, fondo, fianchi: materico avana (due lati) • Back: Avana textured finish Top, bottom, sides: Avana textured finish (two sides) 	<ul style="list-style-type: none"> • Schiena: materico avana Coperchio, fondo, fianchi: lato interno materico avana, lato esterno in finitura come il frontale • Back: Avana textured finish Top, bottom, sides: internal side in Avana textured finish, external side in finish like the front

Maggiorazione per fianchi in finitura per basi e colonne a pagina 17-18. Spalle di finitura optional sp. 22 mm per basi e colonne a pagina 102.

Surcharge for base and tall units finishing sides on pages 17-18. Optional side panels 22 mm th for base and tall units on page 102.

FRONTALI FRONTS



FRONTALI: pannelli di particelle di legno certificati CARB-02 sp. 18 mm rivestiti con nobilitazione melaminica due lati o laccati un lato (lato interno sempre in melaminico avana); bordatura poliuretana idrorepellente. Senso vena sempre verticale.

FRONTS: CARB-02-certified 18 mm thick particleboard panels with melamine coating on two side or lacquered on one sides (inner side always Avana textured finish); water-repellent polyurethane edging. Grain direction always vertical.

MANIGLIA: in alluminio disponibile nelle finiture bianco, nero, titanio o laccato opaco con maggiorazione. Posizione orizzontale nelle basi, verticale nelle colonne, orizzontale o verticale nei pensili. Nei moduli a doppia anta con maniglia verticale quest'ultima è presente solo nell'anta destra.

HANDLE: aluminium handle available in white, black titanium or matt lacquer finishes with surcharge. Horizontal for base units, vertical for tall units, horizontal or vertical for wall units. In double door modules with vertical handle, the handle is only on the right door.

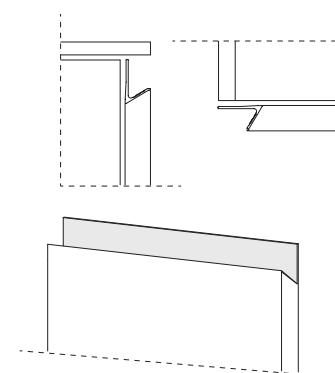

Maggiorazione per maniglia nelle finiture laccato opaco: + € 38.

Surcharge for handle in matt lacquered finishes: + € 38.

CARATTERISTICHE TECNICHE

Technical Features

IDROBOX

ANTE RIENTRANTI

POCKET DOORS



L'apertura avviene mediante scorrimento su apposite guide montate sul lato interno dei fianchi. Grazie a questo meccanismo si ottiene un ambiente ordinato quando le ante in luce sono chiuse e uno spazio organizzato e pratico nel momento della loro apertura.

La struttura di questi moduli è realizzata con pannelli sp. 22 mm in finitura come il frontale. Le ante rientranti sono disponibili per basi lavabo, basi e colonne portalavatrice.

The doors slide open on special runners mounted on the inside of the side panels. Thanks to this mechanism, an orderly environment is achieved when the flush doors are closed and an organized and practical space when they are open.

The structure is made of 22 mm thick panels in finish like the front. Pocket doors are available for washbasin units and washing machine base and tall units.

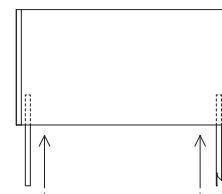
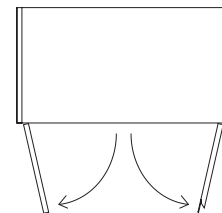

ANTE SOFFIETTO

FOLDING DOORS



L'apertura avviene tramite impacchettamento delle ante fissate ad un binario superiore e giuntate con quattro cerniere. L'anta è dotata di chiusura amortizzata.

L'impacchettamento delle ante comporta un ingombro del vano stesso, come indicato sulle specifiche tecniche. Questo sistema di apertura è disponibile per basi e colonne portalavatrice.

The doors are fixed to an upper track and open concertina style. They are joined by four hinges and have a soft-close mechanism.

The doors fold inwards into the compartment, as indicated on the technical specifications. This opening system is available for washing machine base and tall units.

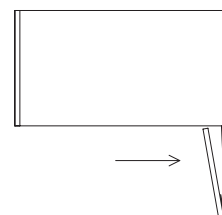
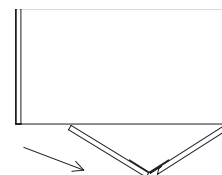

RIPIANI INTERNI

INTERNAL SHELVES



RIPIANI: pannelli di particelle di legno certificati CARB-02 sp. 18 mm rivestiti con nobilitazione melaminica avana; bordatura poliuretanica idrorepellente.

Il prezzo dei moduli è considerato senza ripiani che vanno aggiunti come accessori nella posizione desiderata (ad eccezione di ripiani strutturali, elementi a giorno, moduli portalavatrice e moduli con ante rientranti).

SHELVES: CARB-02-certified 18 mm thick particleboard panels with Avana melamine coating; water-repellent polyurethane edging.

The price of the units is considered without shelves, which must be added as accessories in the desired location (except for structural shelves, open units, washing machine units, and modules with pocket doors).

IDROBOX BASI
IDROBOX BASE UNITS

IDROBOX COLONNE E PENSILI
IDROBOX TALL AND WALL UNITS

IDROBOX ATTREZZATURA
IDROBOX EQUIPMENT

IDROBOX TOP E LAVATOI
IDROBOX TOPS AND WASHBASINS

INGRESSI
HALLWAY CABINETS

SCARPIERE
SHOE CABINETS

ACCESSORI
ACCESSORIES

CARATTERISTICHE TECNICHE

Technical features

IDROBOX

SPONDE E GUIDE PER CASSETTI/CASSETTONI

SIDEBOARDS AND RUNNERS FOR STANDARD/DEEP DRAWERS



SPONDE AVANTECH: Hettich mod. AvanTech YOU caratterizzato da sottili sponde metalliche verniciate antracite, fondi e retri in pannelli di particelle di legno certificati CARB-02 sp. 16 mm con nobilitazione melaminica. Possibilità d'inserimento di luce LED nella parte superiore della sponda.

H sponde cassetti: 10,1 cm
H sponde cassettoni: 18,8 / 25,2 cm

GUIDE: metalliche sincronizzate a scomparsa con estrazione totale, regolazioni invisibili e sistema di chiusura ammortizzata.

AVANTECH SIDEBOARDS Hettich AvanTech YOU consisting of slim, anthracite-painted metal sideboards; bottoms and backs made of CARB-02-certified 16 mm thick particleboard panels with a melamine finish. An LED light can be added at the top of the sideboard.

H sideboards for drawers: 10,1 cm
H sideboards for deep drawers: 18,8 / 25,2 cm

RUNNERS: synchronised, concealed, full pull-out metal runners with invisible adjustment mechanism and soft close.

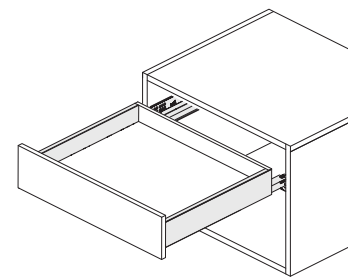

ZOCCOLO E PIEDI

PLINTH AND FEET



ZOCCOLO: H 6 cm in finitura alluminio, nero, bianco oppure nelle colorazioni laccato opaco. Fissaggio mediante aggancio magnetico.

PIEDI: H 1,6 cm regolabili a scomparsa in finitura alluminio oppure H 6 cm nero.

PLINTH: h 6 cm, in aluminium, black, white or colored matt lacquered finishes. Magnetic.

FEET: concealed, adjustable h 1,6 cm in aluminium finish or h 6 cm black.

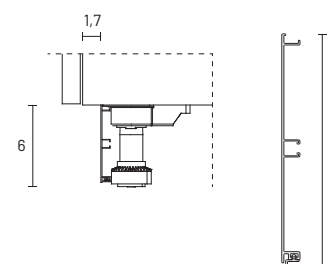

ATTACCAGLIE

FASTENERS



Tutte le attaccaglie sono regolabili e hanno un sistema antisganciamento.

Le basi lavabo sono dotate di attaccaglie con un profilo che copre tutta la larghezza del mobile conferendo maggiore stabilità alla struttura, inoltre hanno 2 staffe tra fianchi e fondo che, tramite un piedino, consentono la regolazione in profondità anche nella parte inferiore.

Le basi hanno attaccaglie interne alla scocca con carter di copertura su apertura battente. Gli altri elementi hanno attaccaglie a scomparsa sempre dotate di copriforo in finitura zama o laccata in tinta su vani a giorno.

Non sono inclusi viti e tasselli per il fissaggio a muro.

All the fasteners are adjustable and have a mechanism to prevent accidental release.

The washbasin units have fasteners with a profile covering the full width of the unit, providing greater stability. They also have two brackets between the sides and bottom which allow the depth to be adjusted using feet, also in the lower part of the unit. Base units have fasteners inside the structure with a cover for the hinged opening. The other units have concealed fasteners with hole covers in a Zamak or matching lacquered finish on open compartments.

Screws and dowels for wall mounting are not included.

POSIZIONAMENTO SCARICHI

Drain positioning

IDROBOX

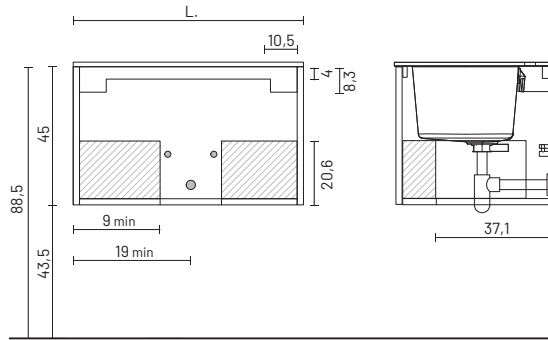

H 45

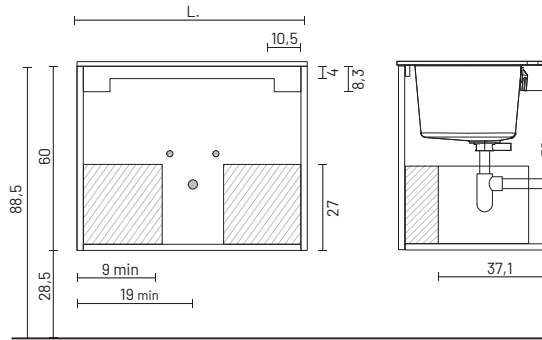

H 60

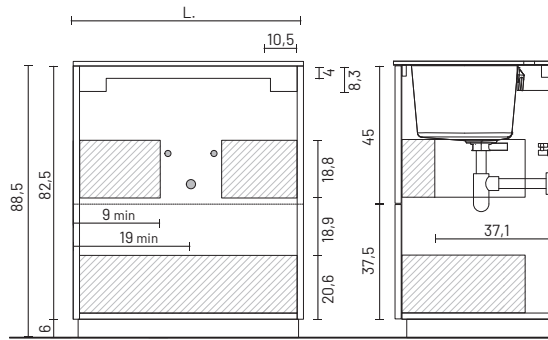

H 82,5

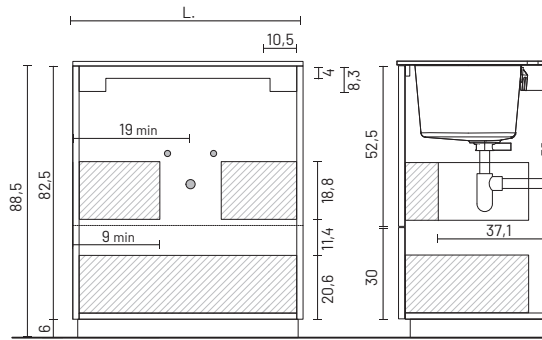

H 82,5

QUOTA SCARICHI CONSIGLIATA
RECOMMENDED DRAIN HEIGHT

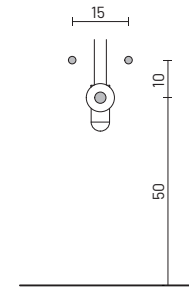

DIMENSIONI VUOTO SANITARIO

SANITARY VACUUM DIMENSIONS

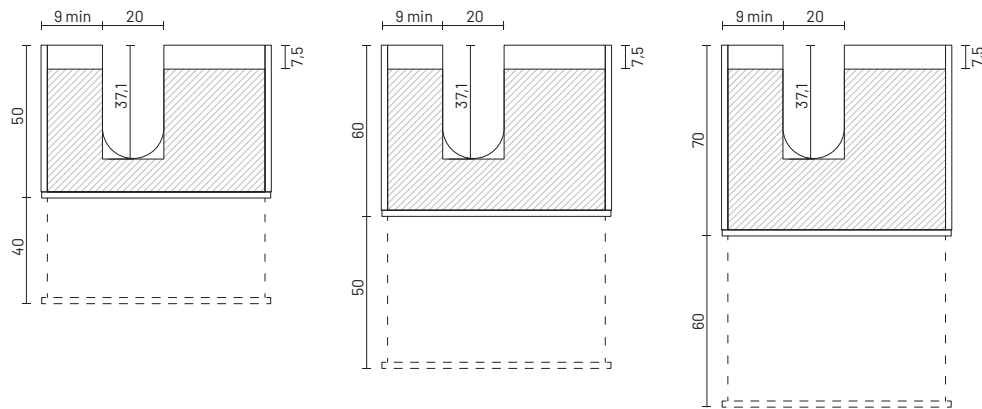

Di serie asse scarico centrale, indicare se diverso.

Standard central drain axes, specify if different.

IDROBOX BASI
IDROBOX BASE UNITS

IDROBOX COLONNE E PENSILI
IDROBOX TALL AND WALL UNITS

IDROBOX ATTREZZATURA
IDROBOX EQUIPMENT

IDROBOX TOP E LAVATOI
IDROBOX TOPS AND WASHBASINS

INGRESSI
HALLWAY CABINETS

SCARPIERE
SHOE CABINETS

ACCESSORI
ACCESSORIES

BASI
BASE UNITS

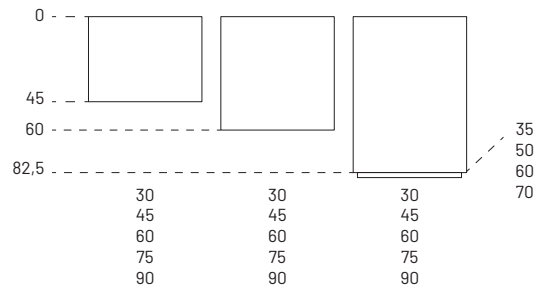

BASI PORTALAVATRICE
WASHING MACHINE BASE UNITS

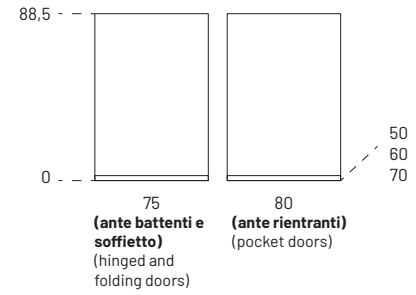

PENSILI
WALL UNITS

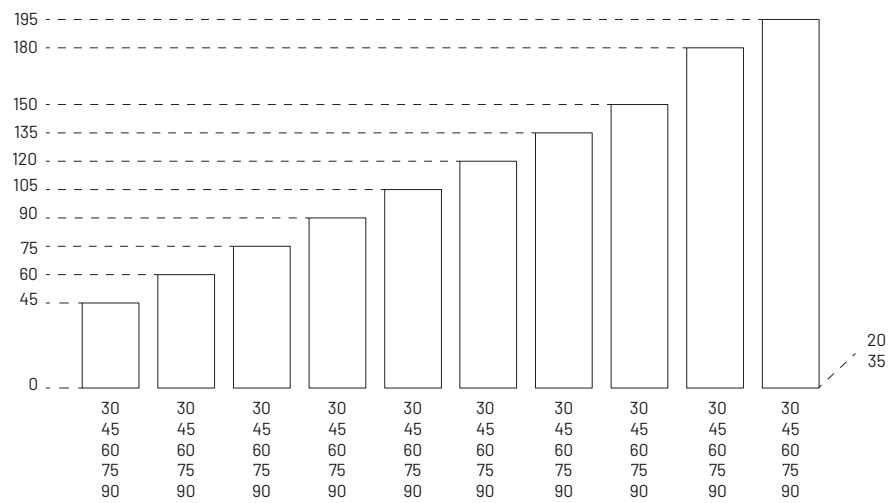

ELEMENTI SOPRALZO
TOP UNITS

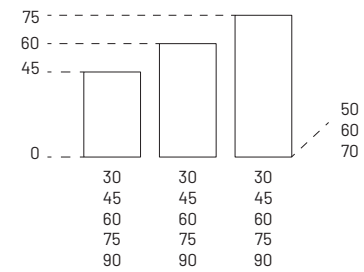

COLONNE A TERRA
FREE-STANDING TALL UNITS

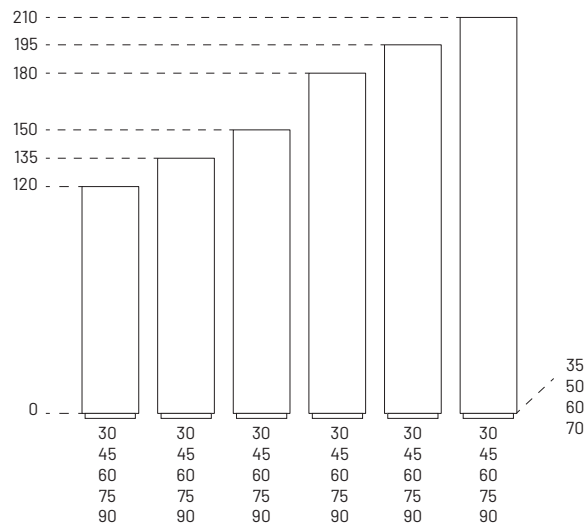

COLONNE PORTALAVATRICE
WASHING MACHINE TALL UNITS

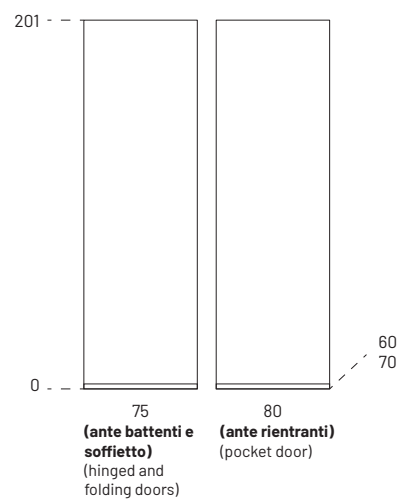

ELEMENTI A GIORNO (SP 4 CM)

OPEN COMPARTMENTS (4 CM TH)

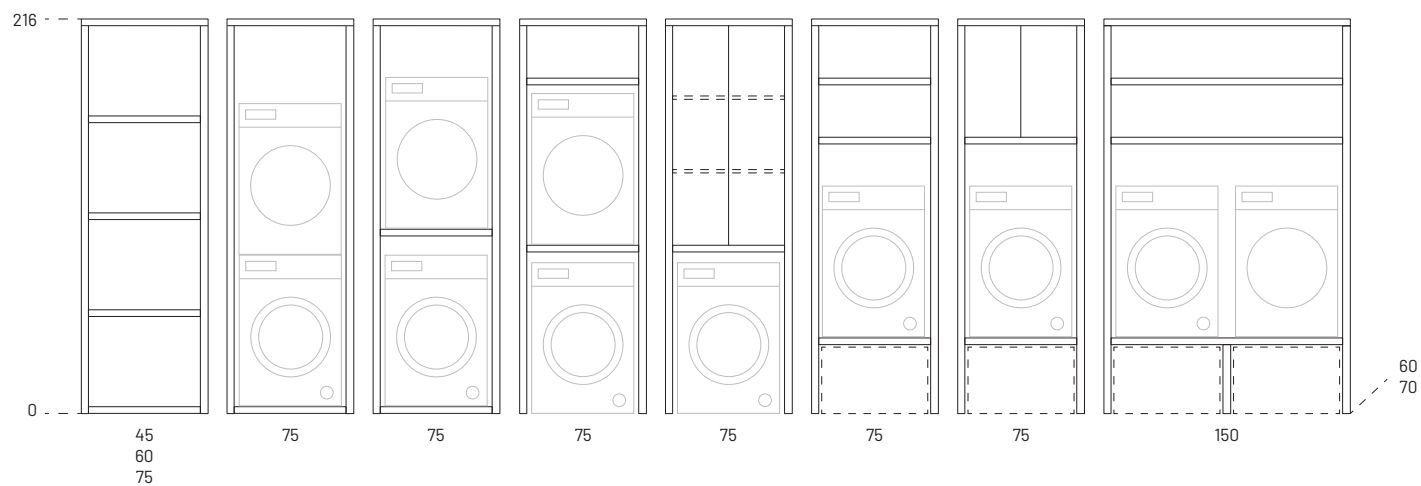
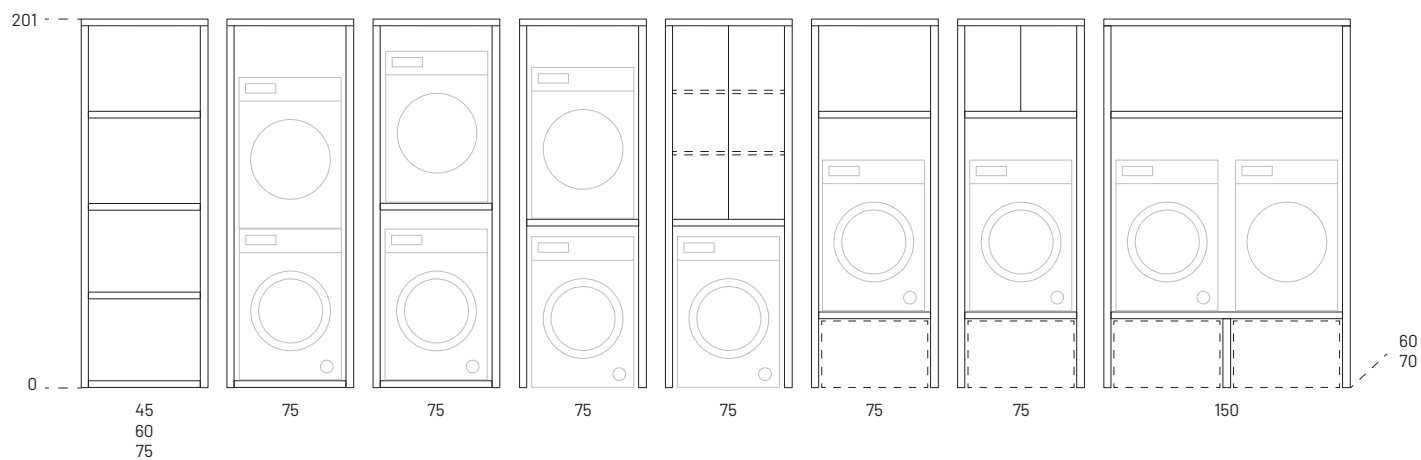
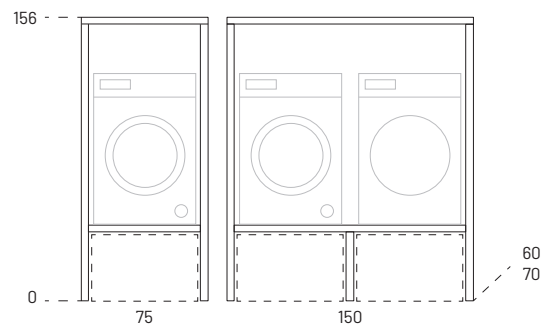

IDROBOX BASI
IDROBOX BASE UNITS

IDROBOX COLONNE E PENSILI
IDROBOX TALL AND WALL UNITS

IDROBOX ATTREZZATURA
IDROBOX EQUIPMENT

IDROBOX TOP E LAVATOI
IDROBOX TOPS AND WASHBASINS

INGRESSI
HALLWAY CABINETS

SCARPIERE
SHOE CABINETS

ACCESSORI
ACCESSORIES

MODULI CON ANTE RIENTRANTI MODULES WITH POCKET DOORS

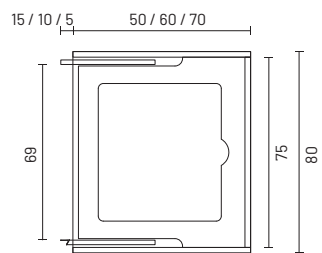
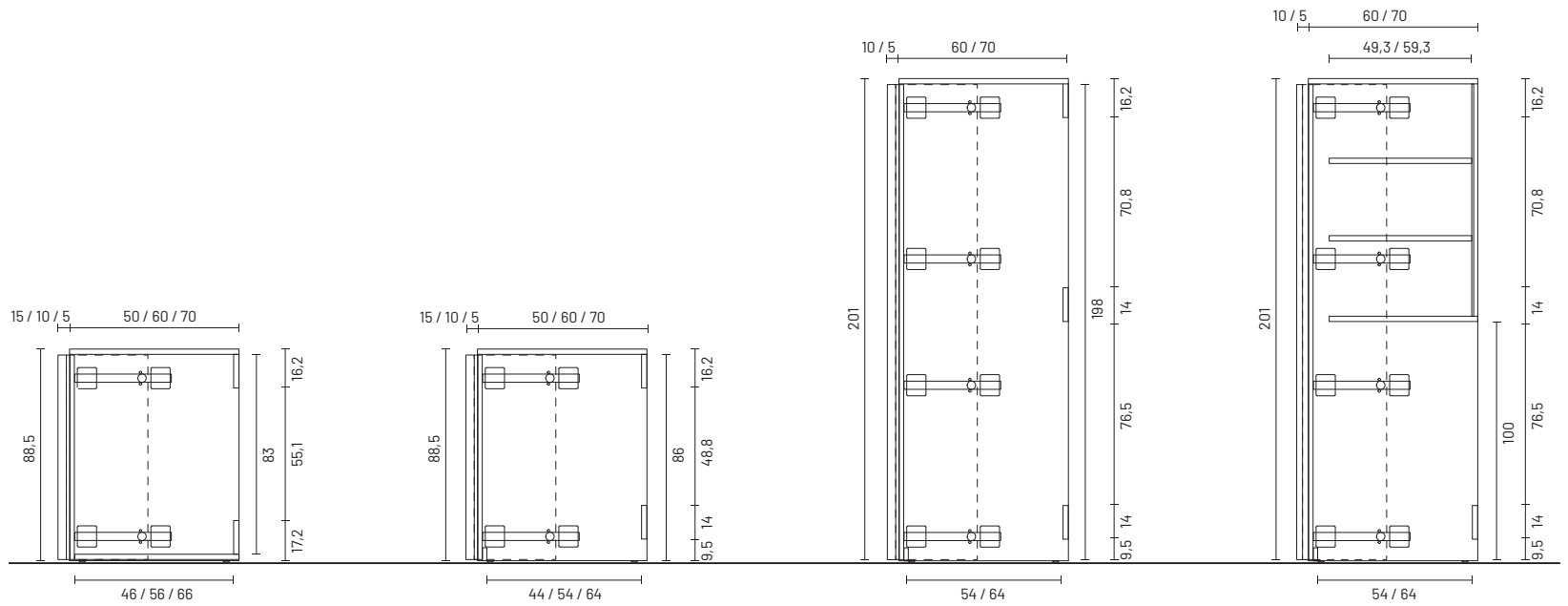

base lavabo
washbasin base

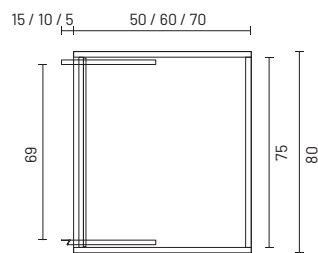

base portalavatrice
washing machine base

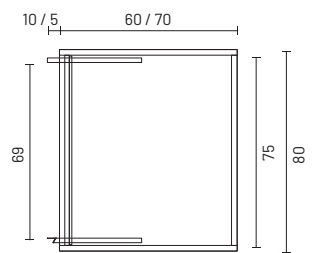

colonna portalavatrice e asciugatrice
tall unit for washer and dryer

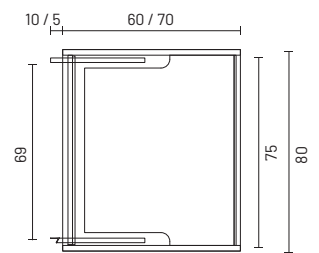

colonna portalavatrice e ripiani
tall unit for washer and shelves

BASI PORTALAVATRICE WASHING MACHINE BASES

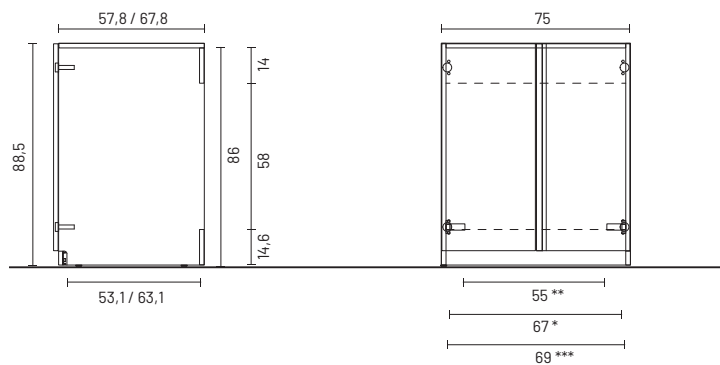

* vano utile con cerniere di serie
** vano utile con cerniere con apertura 180°
*** vano utile con cerniere con apertura 270°

* usable compartment with standard hinges
** usable compartment with 180° hinges
*** usable compartment with 270° opening hinges

SEZIONI TECNICHE

Technical sections

IDROBOX

COLONNE PORTALAVATRICE CON ANTE BATTENTI

WASHING MACHINE TALL UNITS WITH HINGED DOORS

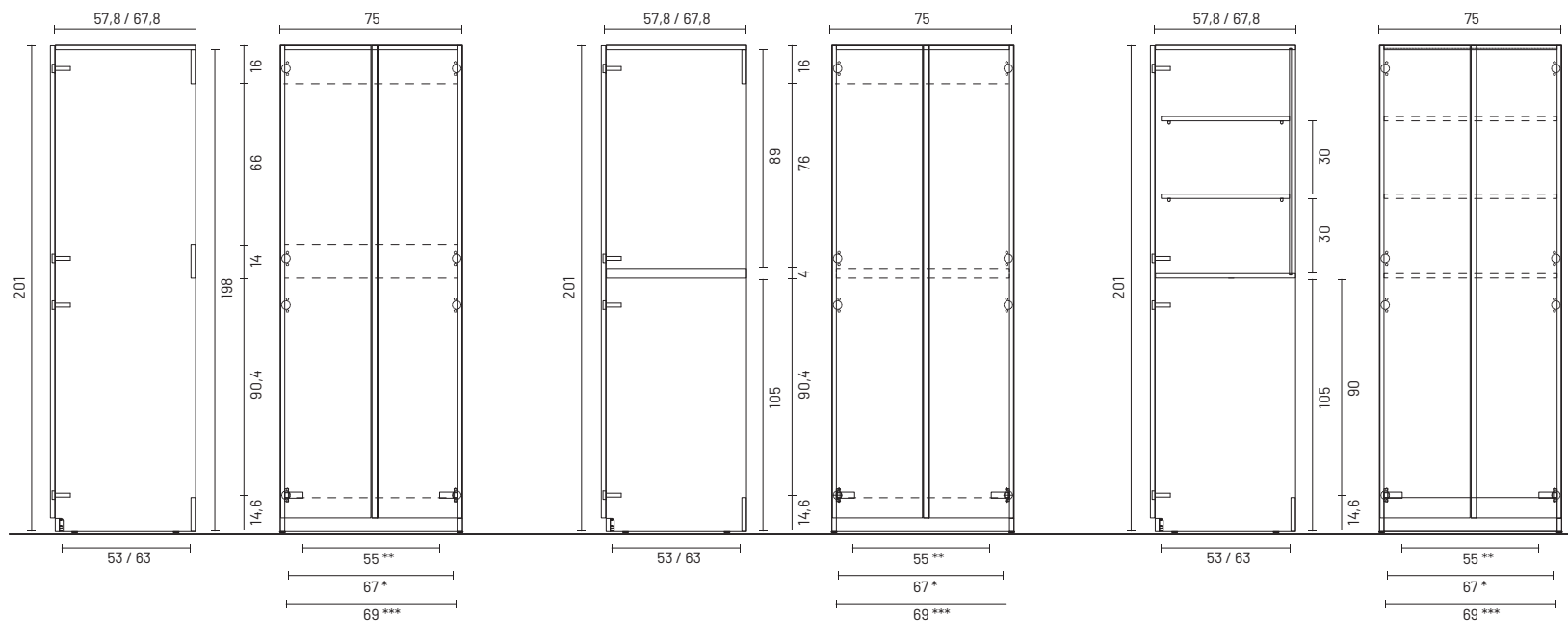

COLONNE PORTALAVATRICE CON ANTE SOFFIETTO

WASHING MACHINE TALL UNITS WITH FOLDING DOORS

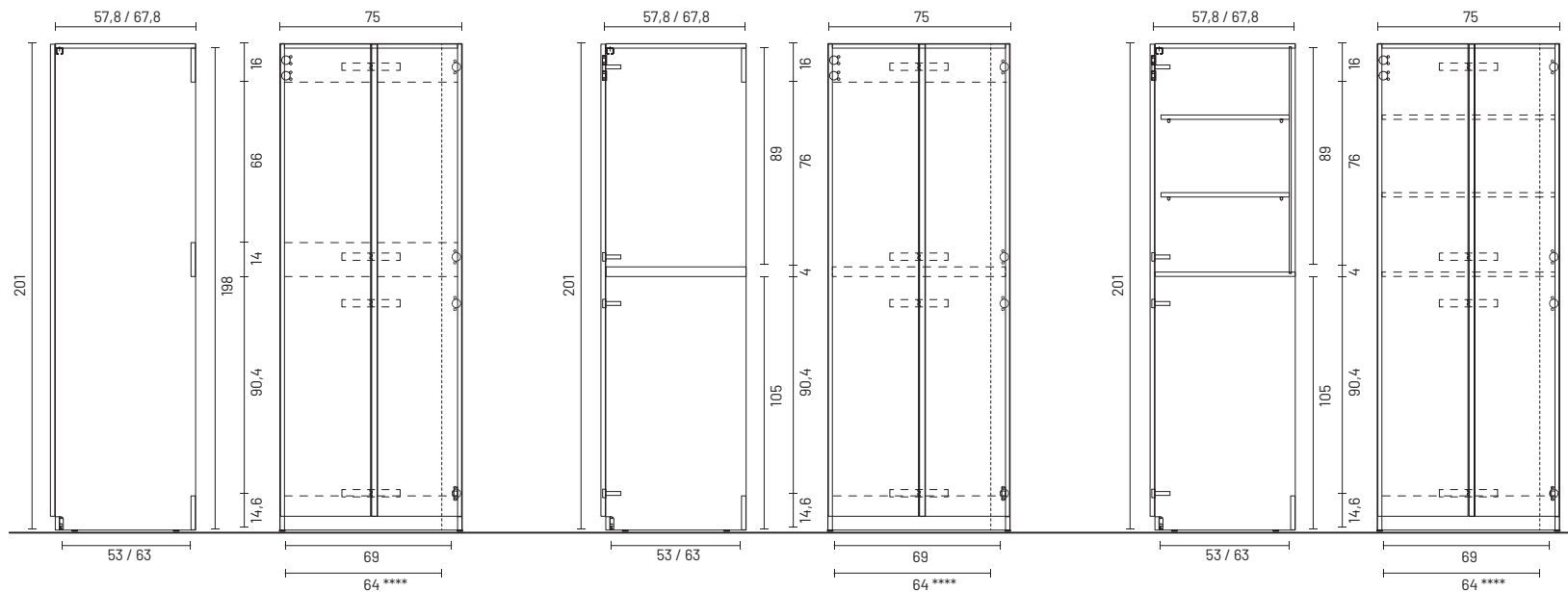

- * vano utile con cerniere di serie
- ** vano utile con cerniere con apertura 180°
- *** vano utile con cerniere con apertura 270°
- **** vano utile con ante aperte

- * usable compartment with standard hinges
- ** usable compartment with 180° hinges
- *** usable compartment with 270° opening hinges
- **** usable compartment with open door

IDROBOX BASI
IDROBOX BASE UNITS

IDROBOX COLONNE E PENSILI
IDROBOX TALL AND WALL UNITS

IDROBOX ATTREZZATURA
IDROBOX EQUIPMENT

IDROBOX TOP E LAVATOI
IDROBOX TOPS AND WASHBASINS

INGRESSI
HALLWAY CABINETS

SCARPIERE
SHOE CABINETS

ACCESSORI
ACCESSORIES

MODULI CON CESTI PORTABIANCHERIA

MODULES WITH LAUNDRY RACK

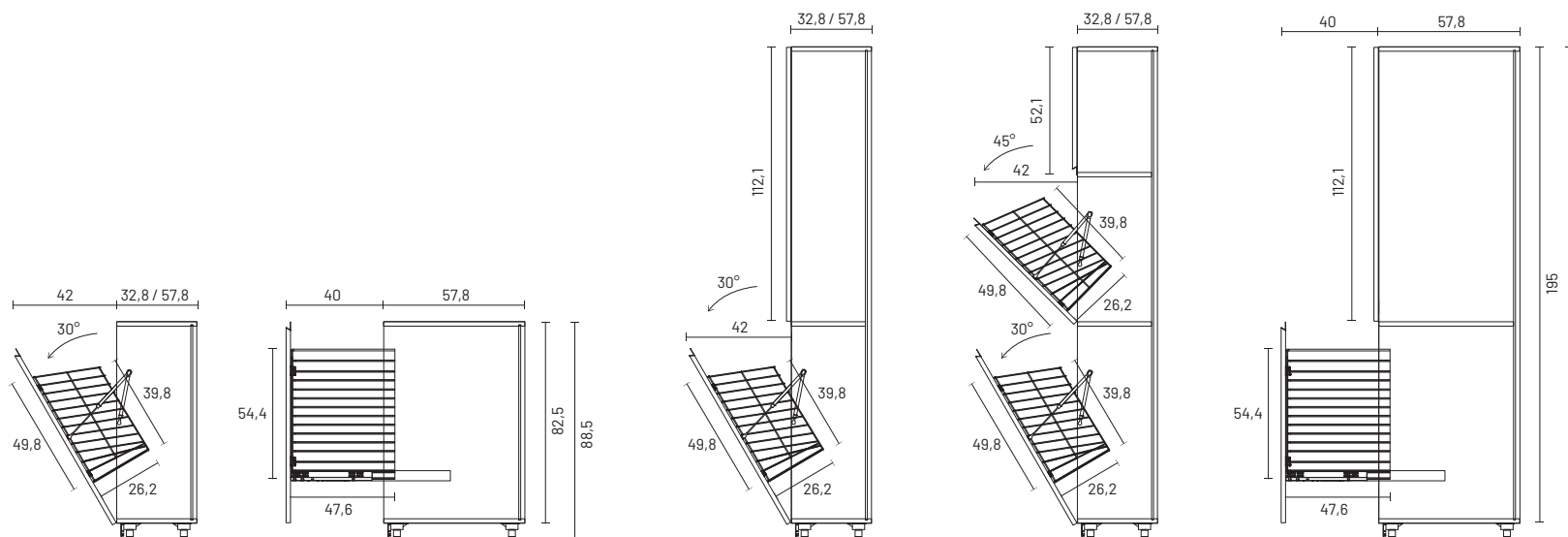

base 1 anta ribalta
1 tilt door base unit

base 1 cestone
1 deep drawer base unit

colonna 1 anta ribalta + 1 anta
1 tilt door + 1 door tall unit

colonna 2 ante ribalta + 1 anta
2 tilt doors + 1 door tall unit

colonna 1 cestone + 1 anta
1 deep drawer + 1 door tall unit

COLONNE CON LAVATOIO

TALL UNITS WITH WASHBASIN

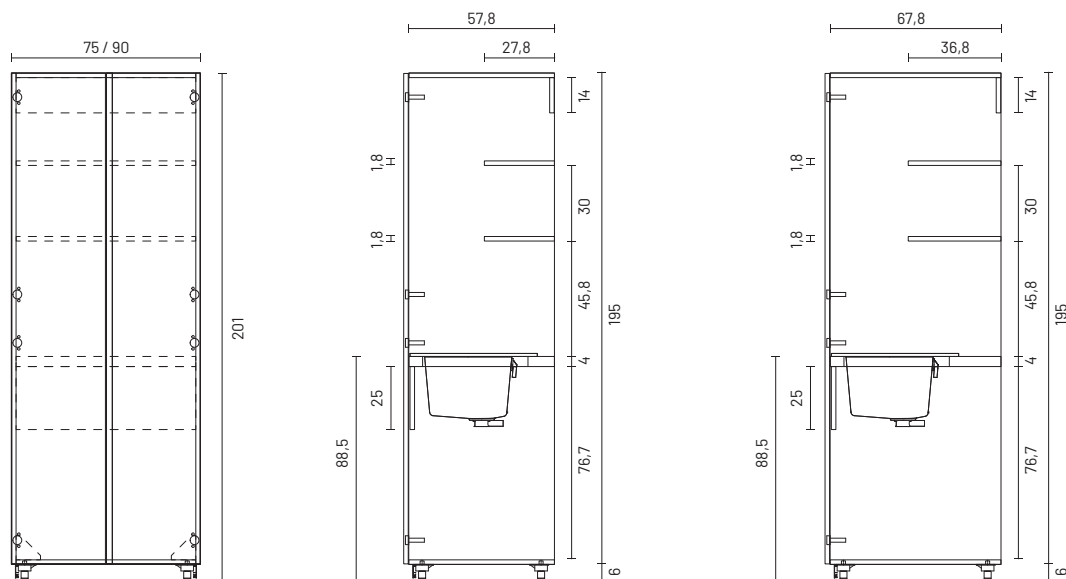

SEZIONI TECNICHE

Technical sections

IDROBOX

COLONNE CON ASSE DA STIRO

TALL UNITS WITH IRONING BOARD

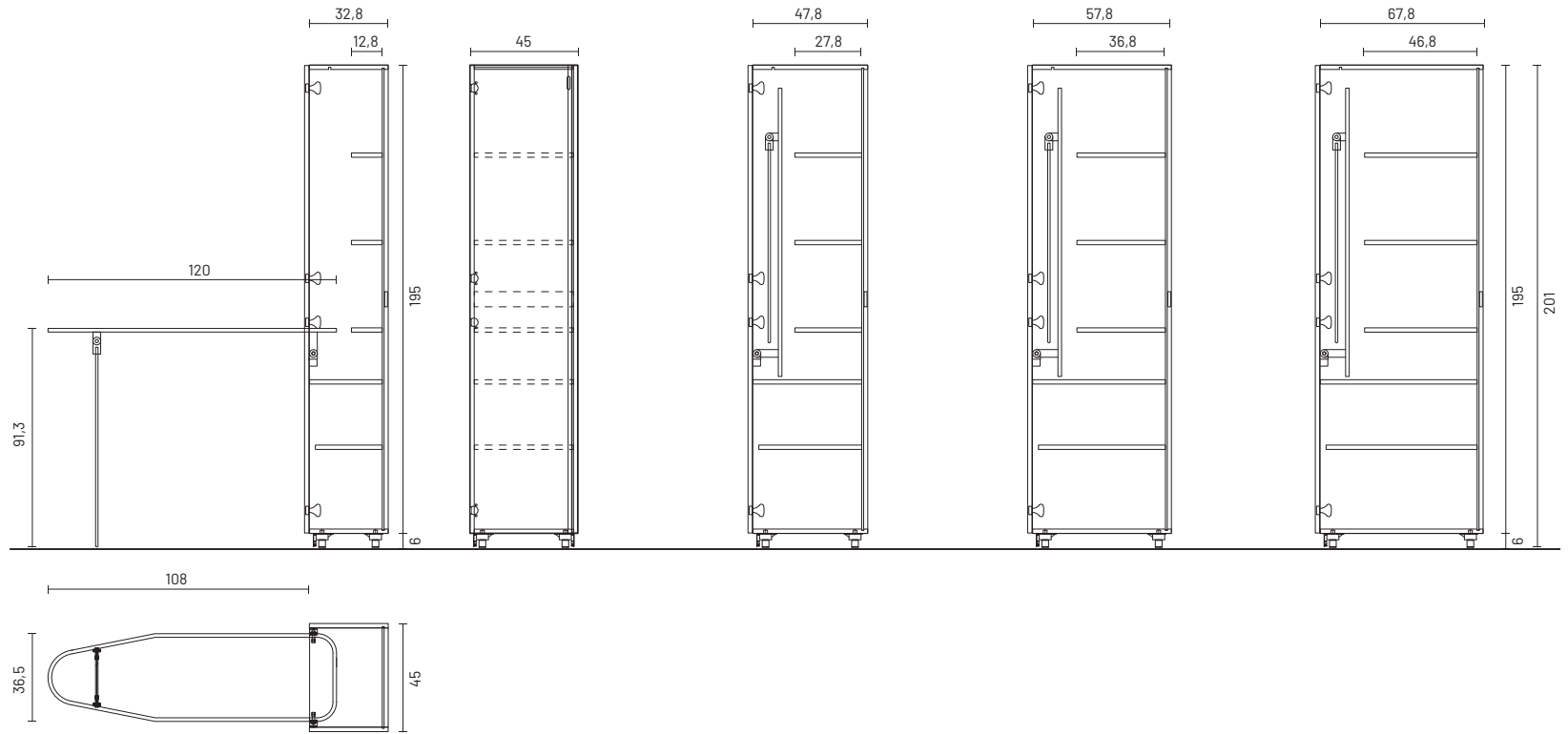

ACCOSTO COLONNA H 195 CM E COLONNA PORTALAVATRICE H 201 CM CON ZOCCOLO UNICO

H 195 CM TALL UNIT NEXT TO H 201 CM TALL UNIT FOR WASHING MACHINE WITH SINGLE PLINTH

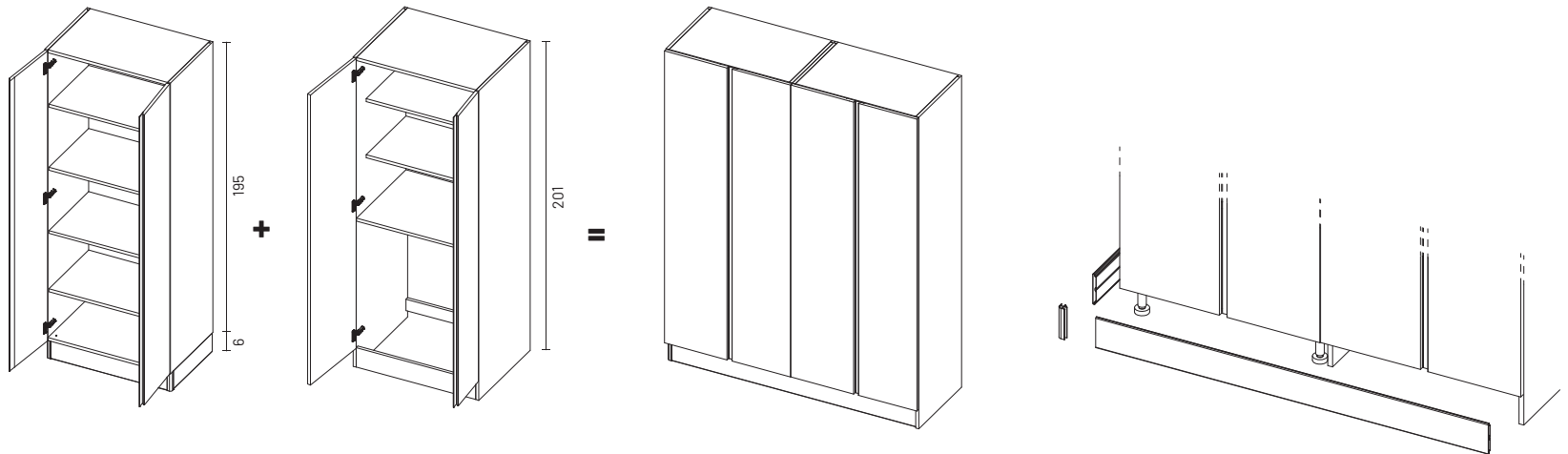

IDROBOX BASI
IDROBOX BASE UNITS

IDROBOX COLONNE E PENSILI
IDROBOX TALL AND WALL UNITS

IDROBOX ATTREZZATURA
IDROBOX EQUIPMENT

IDROBOX TOP E LAVATOI
IDROBOX TOPS AND WASHBASINS

INGRESSI
HALLWAY CABINETS

SCARPIERE
SHOE CABINETS

ACCESSORI
ACCESSORIES

MAGGIORAZIONI PER FUORI MISURA

Surcharges for oversized measurements

IDROBOX

INDICAZIONI GENERALI

GENERAL INFORMATION

Le maggiorazioni per interventi fuori misura dovranno essere applicate sull'elemento di serie con caratteristiche similari e/o misure superiori all'elemento.

È possibile realizzare personalizzazioni fuori misura su elementi con anta/e battente o cassetti/cestoni ma per quest'ultimi va sempre verificata la fattibilità con l'ufficio tecnico.

Quando vengono richiesti più interventi fuori misura sullo stesso elemento, la maggiorazione da applicare è data dalla somma dei singoli interventi.

Per interventi fuori misura particolari, non contemplati in queste pagine, si dovrà richiedere la conferma di fattibilità e conseguente preventivo.

Non si accettano resi di elementi modificati fuori misura.

Surcharges for oversized products must be applied to the standard unit with similar characteristics and/or a larger size.

Oversized customisation is possible on units with hinged door(s) or drawers but please always check feasibility with the technical department for drawers specifically.

When multiple oversized measurement requests are made for the same unit, the surcharge to be applied is the sum of the individual requests.

For special oversized measurements not covered here, please request confirmation of feasibility and a quote.

We do not accept returns of modified oversized units.

RIDUZIONE IN LARGHEZZA

WIDTH REDUCTION

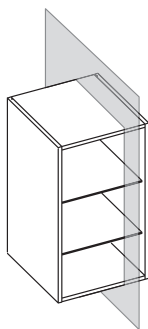

	CODICE CODE	Prezzo Price
basi ante battenti hinged door base units	MGB0020	216
basi ante soffietto/rientranti folding/pocket door base units	MGBS0020	292
basi cassetto base units with drawer	MGBC0020	304
pensili wall units	MGP0020	216
colonne ante battenti hinged door tall units	MGC0020	304
colonne ante soffietto/rientranti folding/pocket door tall units	MGCS0020	292

RIDUZIONE IN PROFONDITÀ

DEPTH REDUCTION

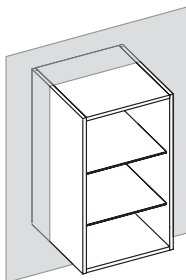

	CODICE CODE	Prezzo Price
basi ante battenti/soffietto hinged/folding door base units	MGB0060	216
basi ante rientranti pocket door base units	MGBS0060	292
basi cassetto base units with drawer	MGBC0060	216
pensili wall units	MGP0060	216
colonne ante battenti/soffietto hinged/folding door tall units	MGC0060	304
colonne ante rientranti pocked door tall units	MGCS0060	292

RIDUZIONE IN ALTEZZA

HEIGHT REDUCTION

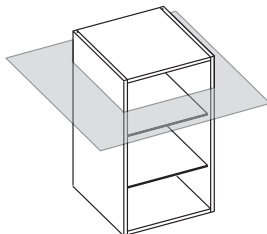

	CODICE CODE	Prezzo Price
basi ante battenti hinged door base units	MGB0040	216
basi ante soffietto/rientranti folding/pocket door base units	MGBS0040	292
basi cassetto base units with drawer	MGBC0040	304
pensili wall units	MGP0040	216
colonne ante battenti hinged door tall units	MGC0040	216
colonne ante soffietto/rientranti folding/pocket door tall units	MGCS0040	292

Non è possibile realizzare modifiche fuori misura per i cassetti interni.

Oversized customisation is it not possible on internal drawers.

MAGGIORAZIONI PER FIANCHI IN FINITURA

Surcharges for finishing sides

IDROBOX

maggiorazione per fianco in finitura per basi

surcharge for finishing side base units

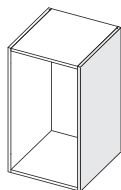

	H H	P D	CODICE CODE	Materico Textured finish	Lacc. opaco Matt lacq.
P 35	45	35	MGF00402	18	38
	60	35	MGF00502	23	50
	82,5	35	MGF00702	32	69
	88,5	35	MGF00802	34	73
P 50	45	50	MGF00404	24	53
	60	50	MGF00504	33	71
	82,5	50	MGF00704	44	98
	88,5	50	MGF00804	48	105
P 60	45	60	MGF00406	29	64
	60	60	MGF00506	38	85
	82,5	60	MGF00706	53	116
	88,5	60	MGF00806	57	125
P 70	45	70	MGF00407	34	75
	60	70	MGF00507	46	99
	82,5	70	MGF00707	62	137
	88,5	70	MGF00807	66	145

Il fianco in finitura materico è in materico 2 lati (interno ed esterno della scocca). Il fianco laccato è laccato in finitura dal lato esterno e materico avana nel lato interno.

Textured finishing sides have the textured finish on 2 sides (inside and outside of the structure). Lacquered finishing side are lacquered on the external face and have a textured Avana finish on the internal face.

IDROBOX BASI
IDROBOX BASE UNITS

IDROBOX COLONNE E PENSILI
IDROBOX TALL AND WALL UNITS

IDROBOX ATTREZZATURA
IDROBOX EQUIPMENT

IDROBOX TOP E LAVATOI
IDROBOX TOPS AND WASHBASINS

INGRESSI
HALLWAY CABINETS

SCARPIERE
SHOE CABINETS

ACCESSORI
ACCESSORIES

MAGGIORAZIONI PER FIANCHI IN FINITURA

Surcharges for finishing sides

IDROBOX

maggiorazione per fianco in finitura per colonne
surcharge for finishing side for tall units

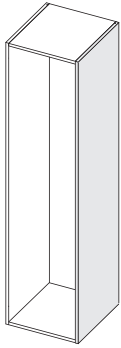

H	P	CODICE	Materico	Lacc. opaco
H	D	CODE	Textured finish	Matt lacq.

P 20	H	P	CODICE	Materico	Lacc. opaco
	H	D	CODE	Textured finish	Matt lacq.
	120	20	MGF00A01	26	57
	135	20	MGF00B01	29	64
	150	20	MGF00C01	33	71
	180	20	MGF00D01	38	85
	195	20	MGF00E01	42	92
	210	20	MGF00F01	46	99

P 35	H	P	CODICE	Materico	Lacc. opaco
	H	D	CODE	Textured finish	Matt lacq.
	120	35	MGF00A02	46	99
	135	35	MGF00B02	51	112
	150	35	MGF00C02	56	124
	180	35	MGF00D02	67	148
	195	35	MGF00E02	72	160
	210	35	MGF00F02	78	172

P 50	H	P	CODICE	Materico	Lacc. opaco
	H	D	CODE	Textured finish	Matt lacq.
	120	50	MGF00A04	64	141
	135	50	MGF00B04	72	158
	150	50	MGF00C04	80	175
	180	50	MGF00D04	96	211
	195	50	MGF00E04	104	228
	210	50	MGF00F04	112	246

P 60	H	P	CODICE	Materico	Lacc. opaco
	H	D	CODE	Textured finish	Matt lacq.
	120	60	MGF00A06	77	169
	135	60	MGF00B06	86	189
	150	60	MGF00C06	96	211
	180	60	MGF00D06	114	253
	195	60	MGF00E06	124	274
	210	60	MGF00F06	133	295

P 70	H	P	CODICE	Materico	Lacc. opaco
	H	D	CODE	Textured finish	Matt lacq.
	120	70	MGF00A07	90	197
	135	70	MGF00B07	100	222
	150	70	MGF00C07	112	246
	180	70	MGF00D07	133	295
	195	70	MGF00E07	144	319
	210	70	MGF00F07	155	344

Il fianco in finitura materico è in materico 2 lati (interno ed esterno della scocca). Il fianco laccato è laccato in finitura dal lato esterno e materico avana nel lato interno.

Textured finishing sides have the textured finish on 2 sides (inside and outside of the structure). Lacquered finishing side are lacquered on the external face and have a textured Avana finish on the internal face.

BASI LAVABO WASHBASIN UNITS	P. 20
BASI BASE UNITS	P. 28
BASI PORTALAVATRICE WASHING MACHINE BASE UNITS	P. 42

BASI LAVABO H 45 cm

Washbasin units h 45 cm

IDROBOX

1 anta ribalta

1 tilt door

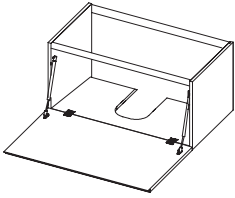

L W	H H	P D	CODICE CODE
--------	--------	--------	----------------

Materico Textured finish	Lacc. opaco Matt lacq.
-----------------------------	---------------------------

	L W	H H	P D	CODICE CODE	Materico Textured finish	Lacc. opaco Matt lacq.
P 50	45	45	50	IRBL6424	389	422
	60	45	50	IRBL6434	418	454
	75	45	50	IRBL6444	440	481
	90	45	50	IRBL6454	461	508
P 60	45	45	60	IRBL6426	402	435
	60	45	60	IRBL6436	432	467
	75	45	60	IRBL6446	454	495
	90	45	60	IRBL6456	475	524
P 70	45	45	70	IRBL6427	414	448
	60	45	70	IRBL6437	445	481
	75	45	70	IRBL6447	467	510
	90	45	70	IRBL6457	490	539

1 cassettone sagomato

1 shaped deep drawer

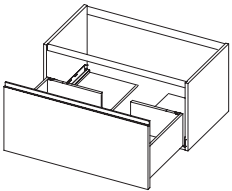

L W	H H	P D	CODICE CODE
--------	--------	--------	----------------

Materico Textured finish	Lacc. opaco Matt lacq.
-----------------------------	---------------------------

	L W	H H	P D	CODICE CODE	Materico Textured finish	Lacc. opaco Matt lacq.
P 50	45	45	50	IRBL1424	450	472
	60	45	50	IRBL1434	484	508
	75	45	50	IRBL1444	519	548
	90	45	50	IRBL1454	553	589
P 60	45	45	60	IRBL1426	465	489
	60	45	60	IRBL1436	501	524
	75	45	60	IRBL1446	536	566
	90	45	60	IRBL1456	573	609
P 70	45	45	70	IRBL1427	480	504
	60	45	70	IRBL1437	517	543
	75	45	70	IRBL1447	553	586
	90	45	70	IRBL1457	591	627

Fianchi di serie in finitura materico avana. Maggiorazione per fianchi in finitura come il frontale a pagina 17-18.

Standard sides in Avana textured finish. Surcharge for sides in finish like the front on page 17-18.

BASI LAVABO H 60 cm

Washbasin units h 60 cm

IDROBOX

1 cassettone sagomato

1 shaped deep drawer

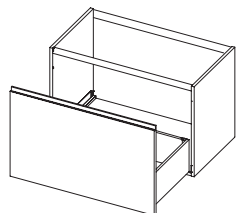

1 anta dx o sx

1 R or L door

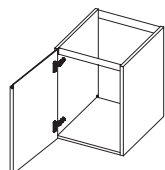

L W	H H	P D	CODICE CODE
--------	--------	--------	----------------

Materico Textured finish	Lacc. opaco Matt lacq.
-----------------------------	---------------------------

P 50	45	60	50	IRBL1524
	60	60	50	IRBL1534
	75	60	50	IRBL1544
	90	60	50	IRBL1554

502	542
538	582
577	627
617	671

P 60	45	60	60	IRBL1526
	60	60	60	IRBL1536
	75	60	60	IRBL1546
	90	60	60	IRBL1556

517	559
555	601
596	646
637	693

P 70	45	60	70	IRBL1527
	60	60	70	IRBL1537
	75	60	70	IRBL1547
	90	60	70	IRBL1557

532	575
573	618
613	666
655	713

L W	H H	P D	CODICE CODE
--------	--------	--------	----------------

Materico Textured finish	Lacc. opaco Matt lacq.
-----------------------------	---------------------------

P 50	45	60	50	IRBL8524
	60	60	50	IRBL8534

382	425
411	456

P 60	45	60	60	IRBL8526
	60	60	60	IRBL8536

394	438
425	471

P 70	45	60	70	IRBL8527
	60	60	70	IRBL8537

407	452
437	486

Fianchi di serie in finitura materico avana. Maggiorazione per fianchi in finitura come il frontale a pagina 17-18.
Maggiorazione per cerniera 180° su ante battenti € 15.

Standard sides in Avana textured finish. Surcharge for sides in finish like the front on page 17-18.
Surcharge for 180° hinge on hinged doors € 15

IDROBOX BASI
IDROBOX BASE UNITS

IDROBOX COLONNE E PENSILI
IDROBOX TALL AND WALL UNITS

IDROBOX ATTREZZATURA
IDROBOX EQUIPMENT

IDROBOX TOP E LAVATOI
IDROBOX TOPS AND WASHBASINS

INGRESSI
HALLWAY CABINETS

SCARPIERE
SHOE CABINETS

ACCESSORI
ACCESSORIES

BASI LAVABO H 60 cm

Washbasin units h 60 cm

IDROBOX

2 ante
2 doors

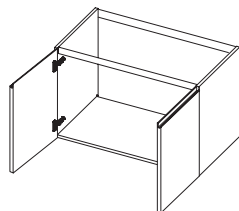

L W	H H	P D	CODICE CODE
--------	--------	--------	----------------

Materico Textured finish	Lacc. opaco Matt lacq.
-----------------------------	---------------------------

	L W	H H	P D	CODICE CODE	Materico Textured finish	Lacc. opaco Matt lacq.
P 50	60	60	50	IRBL9534	451	502
	75	60	50	IRBL9544	474	531
	90	60	50	IRBL9554	495	560
P 60	60	60	60	IRBL9536	465	517
	75	60	60	IRBL9546	489	547
	90	60	60	IRBL9556	510	577
P 70	60	60	70	IRBL9537	479	532
	75	60	70	IRBL9547	503	563
	90	60	70	IRBL9557	525	594

Fianchi di serie in finitura materico avana. Maggiorazione per fianchi in finitura come il frontale a pagina 17-18.
Maggiorazione per cerniera 180° su ante battenti € 15.

Standard sides in Avana textured finish. Surcharge for sides in finish like the front on page 17-18.
Surcharge for 180° hinge on hinged doors € 15

BASI LAVABO A TERRA H 82,5 cm

Floor-standing washbasin units h 82,5 cm

IDROBOX

1 cassettone sagomato H 44,6 + 1 cassetto H 37,1

1 shaped deep drawer H 44,6 + 1 drawer H 37,1

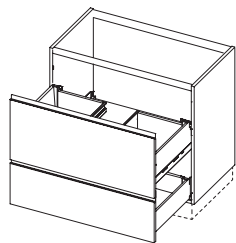

L W	H H	P D	CODICE CODE	Materico Textured finish	Lacc. opaco Matt lacq.
--------	--------	--------	----------------	-----------------------------	---------------------------

P 50	45	82,5	50	IRBL5724	627	687
	60	82,5	50	IRBL5734	674	738
	75	82,5	50	IRBL5744	725	798
	90	82,5	50	IRBL5754	776	857

P 60	45	82,5	60	IRBL5726	647	710
	60	82,5	60	IRBL5736	696	763
	75	82,5	60	IRBL5746	749	825
	90	82,5	60	IRBL5756	801	885

P 70	45	82,5	70	IRBL5727	668	733
	60	82,5	70	IRBL5737	719	788
	75	82,5	70	IRBL5747	773	852
	90	82,5	70	IRBL5757	828	914

1 cassettone sagomato H 52,1 + 1 cassetto H 29,6

1 shaped deep drawer H 52,1 + 1 drawer H 29,6

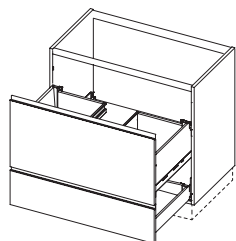

L W	H H	P D	CODICE CODE	Materico Textured finish	Lacc. opaco Matt lacq.
--------	--------	--------	----------------	-----------------------------	---------------------------

P 50	45	82,5	50	IRBL4724	627	687
	60	82,5	50	IRBL4734	674	738
	75	82,5	50	IRBL4744	725	798
	90	82,5	50	IRBL4754	776	857

P 60	45	82,5	60	IRBL4726	647	710
	60	82,5	60	IRBL4736	696	763
	75	82,5	60	IRBL4746	749	825
	90	82,5	60	IRBL4756	801	885

P 70	45	82,5	70	IRBL4727	668	733
	60	82,5	70	IRBL4737	719	788
	75	82,5	70	IRBL4747	773	852
	90	82,5	70	IRBL4757	828	914

Sommare alla composizione il prezzo dello zoccolo o dei piedini H 6 cm (pagina 103).
Fianchi di serie in finitura materico avana. Maggiorazione per fianchi in finitura come il frontale a pagina 17-18.

Add the price of the plinth or H 6 cm feet to the composition (page 103).
Standard sides in Avana textured finish. Surcharge for sides in finish like the front on page 17-18.

IDROBOX BASI
IDROBOX BASE UNITS

IDROBOX COLONNE E PENSILI
IDROBOX TALL AND WALL UNITS

IDROBOX ATTREZZATURA
IDROBOX EQUIPMENT

IDROBOX TOP E LAVATOI
IDROBOX TOPS AND WASHBASINS

INGRESSI
HALLWAY CABINETS

SCARPIERE
SHOE CABINETS

ACCESSORI
ACCESSORIES

BASI LAVABO A TERRA H 82,5 cm

Floor-standing washbasin units h 82,5 cm

IDROBOX

1 anta dx o sx

1 R or L door

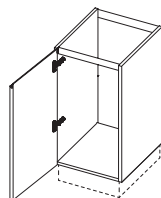

L W	H H	P D	CODICE CODE
--------	--------	--------	----------------

Materico Textured finish	Lacc. opaco Matt lacq.
-----------------------------	---------------------------

P 50	45	82,5	50	IRBL8724	409	466
	60	82,5	50	IRBL8734	435	506
P 60	45	82,5	60	IRBL8726	425	483
	60	82,5	60	IRBL8736	450	524
P 70	45	82,5	70	IRBL8727	438	501
	60	82,5	70	IRBL8737	466	543

2 ante

2 doors

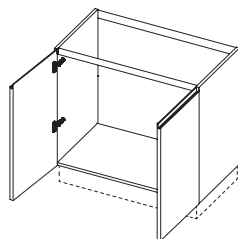

L W	H H	P D	CODICE CODE
--------	--------	--------	----------------

Materico Textured finish	Lacc. opaco Matt lacq.
-----------------------------	---------------------------

P 50	60	82,5	50	IRBL9734	466	543
	75	82,5	50	IRBL9744	490	574
	90	82,5	50	IRBL9754	512	605
P 60	60	82,5	60	IRBL9736	481	561
	75	82,5	60	IRBL9746	505	592
	90	82,5	60	IRBL9756	530	625
P 70	60	82,5	70	IRBL9737	496	578
	75	82,5	70	IRBL9747	521	612
	90	82,5	70	IRBL9757	547	645

Sommare alla composizione il prezzo dello zoccolo o dei piedini H 6 cm (pagina 103).

Fianchi di serie in finitura materico avana. Maggiorazione per fianchi in finitura come il frontale a pagina 17-18.

Maggiorazione per cerniera 180° su ante battenti € 15.

Add the price of the plinth or H 6 cm feet to the composition (page 103).

Standard sides in Avana textured finish. Surcharge for sides in finish like the front on page 17-18.

Surcharge for 180° hinge on hinged doors € 15

BASI LAVABO SEMI-INCASSO H 82,5 cm

Semi-recessed washbasin bases h 82,5 cm

IDROBOX

1 anta dx o sx

1 R or L door

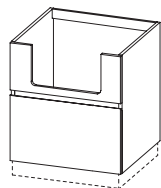

L W	H H	P D	CODICE CODE
--------	--------	--------	----------------

Materico Textured finish	Lacc. opaco Matt lacq.
-----------------------------	---------------------------

P 35	60	82,5	35	IRBI8732
------	----	------	----	----------

490	538
-----	-----

2 ante

2 doors

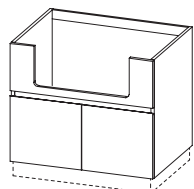

L W	H H	P D	CODICE CODE
--------	--------	--------	----------------

Materico Textured finish	Lacc. opaco Matt lacq.
-----------------------------	---------------------------

P 35	60	82,5	35	IRBI9732
	75	82,5	35	IRBI9742
	90	82,5	35	IRBI9752

412	488
429	523
455	567

Sommare alla composizione il prezzo dello zoccolo o dei piedini H 6 cm (pagina 103).

Piano con lavatoio integrato compatibile a pagina 124.

Fianchi di serie in finitura materico avana. Maggiorazione per fianchi in finitura come il frontale a pagina 17-18.

Maggiorazione per cerniera 180° su ante battenti € 15.

Add the price of the plinth or H 6 cm feet to the composition (page 103).

Compatible built-in top at page 124.

Standard sides in Avana textured finish. Surcharge for sides in finish like the front on page 17-18.

Surcharge for 180° hinge on hinged doors € 15

IDROBOX BASI
IDROBOX BASE UNITS

IDROBOX COLONNE E PENSILI
IDROBOX TALL AND WALL UNITS

IDROBOX ATTREZZATURA
IDROBOX EQUIPMENT

IDROBOX TOP E LAVATOI
IDROBOX TOPS AND WASHBASINS

INGRESSI
HALLWAY CABINETS

SCARPIERE
SHOE CABINETS

ACCESSORI
ACCESSORIES

BASI LAVABO ANGOLO H 82,5 cm

Corner washbasin units h 82,5 cm

IDROBOX

1 anta dx o sx

1 R or L door

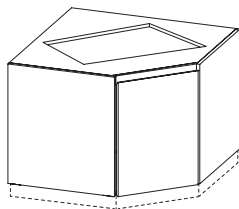

	L W	H H	P D	CODICE CODE	Materico Textured finish	Lacc. opaco Matt lacq.
P 82	82	82,5	82	IRBLA744	520	575
P 92	92	82,5	92	IRBLA755	572	625
P 102	102	82,5	102	IRBLA766	629	682

Sommare alla composizione il prezzo dello zoccolo o dei piedini H 6 cm (pagina 103).

Fianchi di serie in finitura materico avana. Maggiorazione per fianchi in finitura come il frontale a pagina 17-18.

Add the price of the plinth or H 6 cm feet to the composition (page 103).

Standard sides in Avana textured finish. Surcharge for sides in finish like the front on page 17-18.

BASI LAVABO CON ANTE RIENTRANTI H 88,5 cm

Washbasin bases with pocket doors h 88,5 cm

IDROBOX

2 ante
2 doors

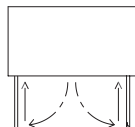
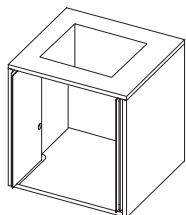

 = smontato
not assembled

L W	H H	P D	CODICE CODE
--------	--------	--------	----------------

Materico Textured finish	Lacc. opaco Matt lacq.
-----------------------------	---------------------------

P 50	80	88,5	50	IRBLR744
-------------	-----------	------	----	----------

631	790
------------	------------

P 60	80	88,5	60	IRBLR746
-------------	-----------	------	----	----------

663	821
------------	------------

P 70	80	88,5	70	IRBLR747
-------------	-----------	------	----	----------

705	863
------------	------------

IDROBOX BASI
IDROBOX BASE UNITS

IDROBOX COLONNE E PENSILI
IDROBOX TALL AND WALL UNITS

IDROBOX ATTREZZATURA
IDROBOX EQUIPMENT

IDROBOX TOP E LAVATOI
IDROBOX TOPS AND WASHBASINS

INGRESSI
HALLWAY CABINETS

SCARPIERE
SHOE CABINETS

ACCESSORI
ACCESSORIES

BASI H 45 cm

Base units h 45 cm

IDROBOX

1 anta ribalta

1 tilt door

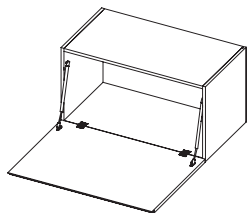

L W	H H	P D	CODICE CODE
--------	--------	--------	----------------

Materico Textured finish	Lacc. opaco Matt lacq.
-----------------------------	---------------------------

	L W	H H	P D	CODICE CODE	Materico Textured finish	Lacc. opaco Matt lacq.
P 35	45	45	35	IRBN6422	349	377
	60	45	35	IRBN6432	376	405
	75	45	35	IRBN6442	413	447
	90	45	35	IRBN6452	449	486
P 50	45	45	50	IRBN6424	385	423
	60	45	50	IRBN6434	414	455
	75	45	50	IRBN6444	454	501
	90	45	50	IRBN6454	493	546
P 60	45	45	60	IRBN6426	397	436
	60	45	60	IRBN6436	427	469
	75	45	60	IRBN6446	467	516
	90	45	60	IRBN6456	508	563
P 70	45	45	70	IRBN6427	408	449
	60	45	70	IRBN6437	440	483
	75	45	70	IRBN6447	481	532
	90	45	70	IRBN6457	523	579

Fianchi di serie in finitura materico avana. Maggiorazione per fianchi in finitura come il frontale a pagina 17-18.

Standard sides in Avana textured finish. Surcharge for sides in finish like the front on page 17-18.

BASI H 45 cm

Base units h 45 cm

IDROBOX

1 cassettone

1 deep drawer

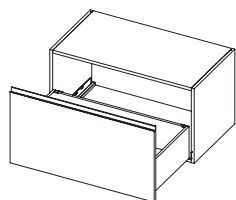

Cassetto interno optional (pagina 97)

Optional internal drawer (page 97)

L W	H H	P D	CODICE CODE
--------	--------	--------	----------------

Materico Textured finish	Lacc. opaco Matt lacq.
-----------------------------	---------------------------

P 35

30	45	35	IRBN1412
45	45	35	IRBN1422
60	45	35	IRBN1432
75	45	35	IRBN1442
90	45	35	IRBN1452

362	371
386	394
405	420
441	458
477	496

P 50

30	45	50	IRBN1414
45	45	50	IRBN1424
60	45	50	IRBN1434
75	45	50	IRBN1444
90	45	50	IRBN1454

390	413
416	438
440	466
479	510
518	553

P 60

30	45	60	IRBN1416
45	45	60	IRBN1426
60	45	60	IRBN1436
75	45	60	IRBN1446
90	45	60	IRBN1456

403	426
430	452
454	481
494	525
534	572

P 70

30	45	70	IRBN1417
45	45	70	IRBN1427
60	45	70	IRBN1437
75	45	70	IRBN1447
90	45	70	IRBN1457

415	438
443	466
467	495
508	543
550	589

Fianchi di serie in finitura materico avana. Maggiorazione per fianchi in finitura come il frontale a pagina 17-18.

Standard sides in Avana textured finish. Surcharge for sides in finish like the front on page 17-18.

IDROBOX BASI
IDROBOX BASE UNITS

IDROBOX COLONNE E PENSILI
IDROBOX TALL AND WALL UNITS

IDROBOX ATTREZZATURA
IDROBOX EQUIPMENT

IDROBOX TOP E LAVATOI
IDROBOX TOPS AND WASHBASINS

INGRESSI
HALLWAY CABINETS

SCARPIERE
SHOE CABINETS

ACCESSORI
ACCESSORIES

BASI H 45 cm

Base units h 45 cm

IDROBOX

2 cassetti H 22,1

2 drawers H 22,1

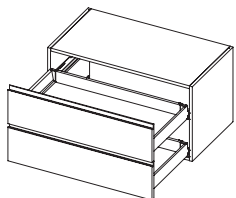

L W	H H	P D	CODICE CODE
--------	--------	--------	----------------

Materico Textured finish	Lacc. opaco Matt lacq.
-----------------------------	---------------------------

P 35	30	45	35	IRBN2412	459	463
	45	45	35	IRBN2422	491	494
	60	45	35	IRBN2432	517	530
	75	45	35	IRBN2442	564	580
	90	45	35	IRBN2452	612	632

P 50	30	45	50	IRBN2414	484	503
	45	45	50	IRBN2424	518	536
	60	45	50	IRBN2434	548	574
	75	45	50	IRBN2444	598	631
	90	45	50	IRBN2454	648	688

P 60	30	45	60	IRBN2416	499	518
	45	45	60	IRBN2426	533	553
	60	45	60	IRBN2436	564	592
	75	45	60	IRBN2446	617	651
	90	45	60	IRBN2456	669	709

P 70	30	45	70	IRBN2417	515	534
	45	45	70	IRBN2427	549	571
	60	45	70	IRBN2437	582	610
	75	45	70	IRBN2447	636	670
	90	45	70	IRBN2457	690	729

1 anta

1 door

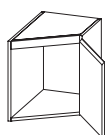
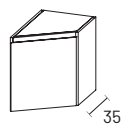

L W	H H	P D	CODICE CODE
--------	--------	--------	----------------

Materico Textured finish	Lacc. opaco Matt lacq.
-----------------------------	---------------------------

P 60	dx rh	40	45	60	IRBT8426D	331	362
	sx lh	40	45	60	IRBT8426S	331	362

Fianchi di serie in finitura materico avana. Maggiorazione per fianchi in finitura come il frontale a pagina 17-18.

Standard sides in Avana textured finish. Surcharge for sides in finish like the front on page 17-18.

BASI H 60 cm

Base units h 60 cm

IDROBOX

1 cassettone

1 deep drawer

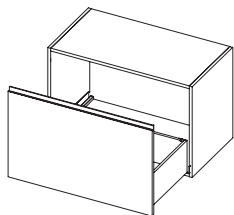

Cassetto interno optional (pagina 97)

Optional internal drawer (page 97)

L W	H H	P D	CODICE CODE
--------	--------	--------	----------------

Materico Textured finish	Lacc. opaco Matt lacq.
-----------------------------	---------------------------

P 35

30	60	35	IRBN1512
45	60	35	IRBN1522
60	60	35	IRBN1532
75	60	35	IRBN1542
90	60	35	IRBN1552

384	402
407	426
426	452
462	495
498	538

P 50

30	60	50	IRBN1514
45	60	50	IRBN1524
60	60	50	IRBN1534
75	60	50	IRBN1544
90	60	50	IRBN1554

417	458
444	485
467	515
507	565
547	616

P 60

30	60	60	IRBN1516
45	60	60	IRBN1526
60	60	60	IRBN1536
75	60	60	IRBN1546
90	60	60	IRBN1556

430	472
458	501
483	531
523	583
564	636

P 70

30	60	70	IRBN1517
45	60	70	IRBN1527
60	60	70	IRBN1537
75	60	70	IRBN1547
90	60	70	IRBN1557

443	486
471	516
496	547
538	601
582	654

BASI H 60 cm

Base units h 60 cm

IDROBOX

2 cassetti H 29,6
2 drawers H 29,6

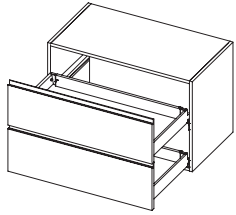

L W	H H	P D	CODICE CODE
--------	--------	--------	----------------

Materico Textured finish	Lacc. opaco Matt lacq.
-----------------------------	---------------------------

	L W	H H	P D	CODICE CODE	Materico Textured finish	Lacc. opaco Matt lacq.
P 35	30	60	35	IRBN2512	490	506
	45	60	35	IRBN2522	521	538
	60	60	35	IRBN2532	546	575
	75	60	35	IRBN2542	593	632
	90	60	35	IRBN2552	641	691
P 50	30	60	50	IRBN2514	518	560
	45	60	50	IRBN2524	551	597
	60	60	50	IRBN2534	583	636
	75	60	50	IRBN2544	634	702
	90	60	50	IRBN2554	687	768
P 60	30	60	60	IRBN2516	534	577
	45	60	60	IRBN2526	569	616
	60	60	60	IRBN2536	602	655
	75	60	60	IRBN2546	654	724
	90	60	60	IRBN2556	708	792
P 70	30	60	70	IRBN2517	549	594
	45	60	70	IRBN2527	587	634
	60	60	70	IRBN2537	619	675
	75	60	70	IRBN2547	674	746
	90	60	70	IRBN2557	729	816

Fianchi di serie in finitura materico avana. Maggiorazione per fianchi in finitura come il frontale a pagina 17-18.

Standard sides in Avana textured finish. Surcharge for sides in finish like the front on page 17-18.

BASI H 60 cm

Base units h 60 cm

IDROBOX

1 cassetto H 22,1+ 1 cassettone H 37,1

1 drawer H 22,1+ 1 deep drawer H 37,1

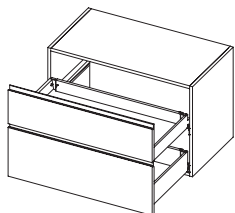

L W	H H	P D	CODICE CODE
--------	--------	--------	----------------

Materico Textured finish	Lacc. opaco Matt lacq.
-----------------------------	---------------------------

P 35

30	60	35	IRBN5512
45	60	35	IRBN5522
60	60	35	IRBN5532
75	60	35	IRBN5542
90	60	35	IRBN5552

490	506
521	538
546	575
593	632
641	691

P 50

30	60	50	IRBN5514
45	60	50	IRBN5524
60	60	50	IRBN5534
75	60	50	IRBN5544
90	60	50	IRBN5554

518	560
551	597
583	636
634	702
687	768

P 60

30	60	60	IRBN5516
45	60	60	IRBN5526
60	60	60	IRBN5536
75	60	60	IRBN5546
90	60	60	IRBN5556

534	577
569	616
602	655
654	724
708	792

P 70

30	60	70	IRBN5517
45	60	70	IRBN5527
60	60	70	IRBN5537
75	60	70	IRBN5547
90	60	70	IRBN5557

549	594
587	634
619	675
674	746
729	816

Fianchi di serie in finitura materico avana. Maggiorazione per fianchi in finitura come il frontale a pagina 17-18.

Standard sides in Avana textured finish. Surcharge for sides in finish like the front on page 17-18.

IDROBOX BASI
IDROBOX BASE UNITS

IDROBOX COLONNE E PENSILI
IDROBOX TALL AND WALL UNITS

IDROBOX ATTREZZATURA
IDROBOX EQUIPMENT

IDROBOX TOP E LAVATOI
IDROBOX TOPS AND WASHBASINS

INGRESSI
HALLWAY CABINETS

SCARPIERE
SHOE CABINETS

ACCESSORI
ACCESSORIES

BASI H 60 cm

Base units h 60 cm

IDROBOX

1 ante dx o sx

1 R or L door

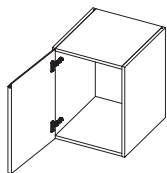

L W	H H	P D	CODICE CODE
--------	--------	--------	----------------

Materico Textured finish	Lacc. opaco Matt lacq.
-----------------------------	---------------------------

	L W	H H	P D	CODICE CODE	Materico Textured finish	Lacc. opaco Matt lacq.
P 35	45	60	35	IRBN8522	305	343
	60	60	35	IRBN8532	326	373
P 50	45	60	50	IRBN8524	334	384
	60	60	50	IRBN8534	362	413
P 60	45	60	60	IRBN8526	345	397
	60	60	60	IRBN8536	374	426
P 70	45	60	70	IRBN8527	356	408
	60	60	70	IRBN8537	386	438

2 ante

2 doors

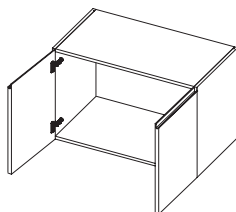

L W	H H	P D	CODICE CODE
--------	--------	--------	----------------

Materico Textured finish	Lacc. opaco Matt lacq.
-----------------------------	---------------------------

	L W	H H	P D	CODICE CODE	Materico Textured finish	Lacc. opaco Matt lacq.
P 35	60	60	35	IRBN9532	369	411
	75	60	35	IRBN9542	405	447
	90	60	35	IRBN9552	444	484
P 50	60	60	50	IRBN9534	404	461
	75	60	50	IRBN9544	447	502
	90	60	50	IRBN9554	488	544
P 60	60	60	60	IRBN9536	418	476
	75	60	60	IRBN9546	462	519
	90	60	60	IRBN9556	505	562
P 70	60	60	70	IRBN9537	432	492
	75	60	70	IRBN9547	477	536
	90	60	70	IRBN9557	521	580

Fianchi di serie in finitura materico avana. Maggiorazione per fianchi in finitura come il frontale a pagina 17-18.
Maggiorazione per cerniera 180° su ante battenti € 15.

Standard sides in Avana textured finish. Surcharge for sides in finish like the front on page 17-18.
Surcharge for 180° hinge on hinged doors € 15

BASI A TERRA H 82,5 cm

Floor-standing base units h 82,5 cm

IDROBOX

1 cassettone H 52,1 + 1 cassetto H 29,6

1 deep drawer H 52,1 + 1 drawer H 29,6

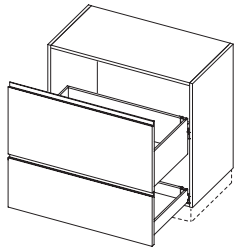

Cassetto interno optional (pagina 97)

Optional internal drawer (page 97)

L W	H H	P D	CODICE CODE
--------	--------	--------	----------------

Materico Textured finish	Lacc. opaco Matt lacq.
-----------------------------	---------------------------

	L W	H H	P D	CODICE CODE	Materico Textured finish	Lacc. opaco Matt lacq.
P 35	30	82,5	35	IRBN5712	545	596
	45	82,5	35	IRBN5722	586	641
	60	82,5	35	IRBN5732	629	690
	75	82,5	35	IRBN5742	677	746
	90	82,5	35	IRBN5752	724	800
P 50	30	82,5	50	IRBN5714	563	618
	45	82,5	50	IRBN5724	606	665
	60	82,5	50	IRBN5734	652	713
	75	82,5	50	IRBN5744	700	771
	90	82,5	50	IRBN5754	750	828
P 60	30	82,5	60	IRBN5716	583	639
	45	82,5	60	IRBN5726	627	687
	60	82,5	60	IRBN5736	674	738
	75	82,5	60	IRBN5746	725	798
	90	82,5	60	IRBN5756	776	857
P 70	30	82,5	70	IRBN5717	603	660
	45	82,5	70	IRBN5727	647	710
	60	82,5	70	IRBN5737	696	763
	75	82,5	70	IRBN5747	749	825
	90	82,5	70	IRBN5757	801	885

Sommare alla composizione il prezzo dello zoccolo o dei piedini H 6 cm (pagina 103).
Fianchi di serie in finitura materico avana. Maggiorazione per fianchi in finitura come il frontale a pagina 17-18.

Add the price of the plinth or H 6 cm feet to the composition (page 103).
Standard sides in Avana textured finish. Surcharge for sides in finish like the front on page 17-18.

IDROBOX BASI
IDROBOX BASE UNITS

IDROBOX COLONNE E PENSILI
IDROBOX TALL AND WALL UNITS

IDROBOX ATTREZZATURA
IDROBOX EQUIPMENT

IDROBOX TOP E LAVATOI
IDROBOX TOPS AND WASHBASINS

INGRESSI
HALLWAY CABINETS

SCARPIERE
SHOE CABINETS

ACCESSORI
ACCESSORIES

BASI A TERRA H 82,5 cm

Floor-standing base units h 82,5 cm

IDROBOX

1 cassettone H 44,6 + 1 cassetto H 37,1

1 deep drawer H 44,6 + 1 drawer H 37,1

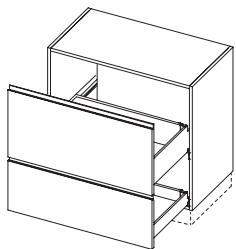

Cassetto interno optional (pagina 97)

Optional internal drawer (page 97)

L W	H H	P D	CODICE CODE
--------	--------	--------	----------------

Materico Textured finish	Lacc. opaco Matt lacq.
-----------------------------	---------------------------

P 35					
	L	H	P	CODICE	
	30	82,5	35	IRBN4712	545
	45	82,5	35	IRBN4722	586
	60	82,5	35	IRBN4732	629
	75	82,5	35	IRBN4742	677
	90	82,5	35	IRBN4752	724

P 50					
	L	H	P	CODICE	
	30	82,5	50	IRBN4714	563
	45	82,5	50	IRBN4724	606
	60	82,5	50	IRBN4734	652
	75	82,5	50	IRBN4744	700
	90	82,5	50	IRBN4754	750

P 60					
	L	H	P	CODICE	
	30	82,5	60	IRBN4716	583
	45	82,5	60	IRBN4726	627
	60	82,5	60	IRBN4736	674
	75	82,5	60	IRBN4746	725
	90	82,5	60	IRBN4756	776

P 70					
	L	H	P	CODICE	
	30	82,5	70	IRBN4717	603
	45	82,5	70	IRBN4727	647
	60	82,5	70	IRBN4737	696
	75	82,5	70	IRBN4747	749
	90	82,5	70	IRBN4757	801

Sommare alla composizione il prezzo dello zoccolo o dei piedini H 6 cm (pagina 103).

Fianchi di serie in finitura materico avana. Maggiorazione per fianchi in finitura come il frontale a pagina 17-18.

Add the price of the plinth or H 6 cm feet to the composition (page 103).

Standard sides in Avana textured finish. Surcharge for sides in finish like the front on page 17-18.

BASI A TERRA H 82,5 cm

Floor-standing base units h 82,5 cm

IDROBOX

2 cassetti H 22,1+ 1 cassetto H 37,1

2 drawers H 22,1+ 1 drawer H 37,1

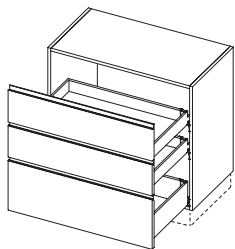

L W	H H	P D	CODICE CODE
--------	--------	--------	----------------

Materico Textured finish	Lacc. opaco Matt lacq.
-----------------------------	---------------------------

	L W	H H	P D	CODICE CODE	Materico Textured finish	Lacc. opaco Matt lacq.
P 35	30	82,5	35	IRBN7712	630	654
	45	82,5	35	IRBN7722	670	696
	60	82,5	35	IRBN7732	704	746
	75	82,5	35	IRBN7742	766	820
	90	82,5	35	IRBN7752	829	896
P 50	30	82,5	50	IRBN7714	663	726
	45	82,5	50	IRBN7724	708	775
	60	82,5	50	IRBN7734	749	826
	75	82,5	50	IRBN7744	816	913
	90	82,5	50	IRBN7754	885	1.001
P 60	30	82,5	60	IRBN7716	683	749
	45	82,5	60	IRBN7726	729	799
	60	82,5	60	IRBN7736	772	852
	75	82,5	60	IRBN7746	842	941
	90	82,5	60	IRBN7756	912	1.032
P 70	30	82,5	70	IRBN7717	705	772
	45	82,5	70	IRBN7727	752	823
	60	82,5	70	IRBN7737	795	879
	75	82,5	70	IRBN7747	868	970
	90	82,5	70	IRBN7757	940	1.062

Sommare alla composizione il prezzo dello zoccolo o dei piedini H 6 cm (pagina 103).
Fianchi di serie in finitura materico avana. Maggiorazione per fianchi in finitura come il frontale a pagina 17-18.

Add the price of the plinth or H 6 cm feet to the composition (page 103).
Standard sides in Avana textured finish. Surcharge for sides in finish like the front on page 17-18.

IDROBOX BASI
IDROBOX BASE UNITS

IDROBOX COLONNE E PENSILI
IDROBOX TALL AND WALL UNITS

IDROBOX ATTREZZATURA
IDROBOX EQUIPMENT

IDROBOX TOP E LAVATOI
IDROBOX TOPS AND WASHBASINS

INGRESSI
HALLWAY CABINETS

SCARPIERE
SHOE CABINETS

ACCESSORI
ACCESSORIES

BASI A TERRA H 82,5 cm

Floor-standing base units h 82,5 cm

IDROBOX

1 ante dx o sx

1 R or L door

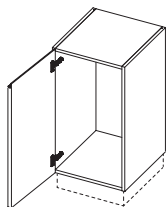

L W	H H	P D	CODICE CODE
--------	--------	--------	----------------

Materico Textured finish	Lacc. opaco Matt lacq.
-----------------------------	---------------------------

	L W	H H	P D	CODICE CODE	Materico Textured finish	Lacc. opaco Matt lacq.
P 35	45	82,5	35	IRBN8722	396	450
	60	82,5	35	IRBN8732	420	489
P 50	45	82,5	50	IRBN8724	409	466
	60	82,5	50	IRBN8734	435	506
P 60	45	82,5	60	IRBN8726	425	483
	60	82,5	60	IRBN8736	450	524
P 70	45	82,5	70	IRBN8727	438	501
	60	82,5	70	IRBN8737	466	543

2 ante

2 doors

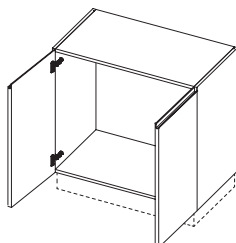

L W	H H	P D	CODICE CODE
--------	--------	--------	----------------

Materico Textured finish	Lacc. opaco Matt lacq.
-----------------------------	---------------------------

	L W	H H	P D	CODICE CODE	Materico Textured finish	Lacc. opaco Matt lacq.
P 35	60	82,5	35	IRBN9732	435	506
	75	82,5	35	IRBN9742	457	535
	90	82,5	35	IRBN9752	478	564
P 50	60	82,5	50	IRBN9734	450	524
	75	82,5	50	IRBN9744	474	555
	90	82,5	50	IRBN9754	495	584
P 60	60	82,5	60	IRBN9736	466	543
	75	82,5	60	IRBN9746	490	574
	90	82,5	60	IRBN9756	512	605
P 70	60	82,5	70	IRBN9737	481	561
	75	82,5	70	IRBN9747	505	592
	90	82,5	70	IRBN9757	530	625

Sommare alla composizione il prezzo dello zoccolo o dei piedini H 6 cm (pagina 103).

Fianchi di serie in finitura materico avana. Maggiorazione per fianchi in finitura come il frontale a pagina 17-18.

Maggiorazione per cerniera 180° su ante battenti € 15.

Add the price of the plinth or H 6 cm feet to the composition (page 103).

Standard sides in Avana textured finish. Surcharge for sides in finish like the front on page 17-18.

Surcharge for 180° hinge on hinged doors € 15

BASI A TERRA H 82,5 cm

Floor-standing base units h 82,5 cm

IDROBOX

1 anta ribalta con cesto portabiancheria

1 tilt door with laundry basket

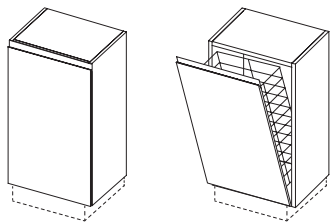

la dimensione del cesto rimane invariata in entrambe le profondità.
the size of the basket is the same in both depths.

1 cestone estraibile con cesto portabiancheria

1 pull-out deep drawer with laundry basket

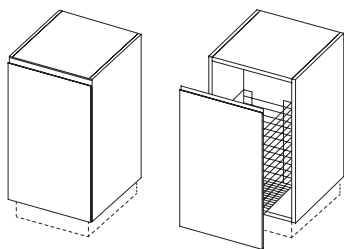

L W	H H	P D	CODICE CODE
--------	--------	--------	----------------

Materico Textured finish	Lacc. opaco Matt lacq.
-----------------------------	---------------------------

P 35	45	82,5	35	IRBNC722
	60	82,5	35	IRBNC732

463	522
509	578

P 60	45	82,5	60	IRBNC726
	60	82,5	60	IRBNC736

492	555
539	611

L W	H H	P D	CODICE CODE
--------	--------	--------	----------------

Materico Textured finish	Lacc. opaco Matt lacq.
-----------------------------	---------------------------

P 60	45	82,5	60	IRBND726
	60	82,5	60	IRBND736

567	626
615	746

Sommare alla composizione il prezzo dello zoccolo o dei piedini H 6 cm (pagina 103).
Fianchi di serie in finitura materico avana. Maggiorazione per fianchi in finitura come il frontale a pagina 17-18.

Add the price of the plinth or H 6 cm feet to the composition (page 103).
Standard sides in Avana textured finish. Surcharge for sides in finish like the front on page 17-18.

IDROBOX BASI
IDROBOX BASE UNITS

IDROBOX COLONNE E PENSILI
IDROBOX TALL AND WALL UNITS

IDROBOX ATTREZZATURA
IDROBOX EQUIPMENT

IDROBOX TOP E LAVATOI
IDROBOX TOPS AND WASHBASINS

INGRESSI
HALLWAY CABINETS

SCARPIERE
SHOE CABINETS

ACCESSORI
ACCESSORIES

BASI ANGOLO H 82,5 cm

Corner base units h 82,5 cm

IDROBOX

1 anta dx o sx

1 R or L door

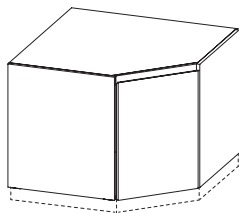

L W	H H	P D	CODICE CODE
--------	--------	--------	----------------

Materico Textured finish	Lacc. opaco Matt lacq.
-----------------------------	---------------------------

P 82	82	82,5	82	IRBNA744	423	472
P 92	92	82,5	92	IRBNA755	452	515
P 102	102	82,5	102	IRBNA766	510	561

1 anta dx o sx (scocca vuota)

1 R or L door (empty structure)

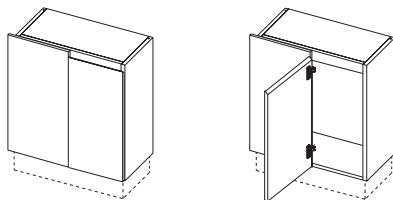

L W	H H	P D	CODICE CODE
--------	--------	--------	----------------

Materico Textured finish	Lacc. opaco Matt lacq.
-----------------------------	---------------------------

P 35	75	82,5	35	IRBNH742	349	443
	97,5	82,5	35	IRBNH752	384	488
	107,5	82,5	35	IRBNH762	423	535
	117,5	82,5	35	IRBNH772	466	588
P 50	75	82,5	50	IRBNH744	373	467
	97,5	82,5	50	IRBNH754	409	515
	107,5	82,5	50	IRBNH764	451	564
	117,5	82,5	50	IRBNH774	495	620
P 60	75	82,5	60	IRBNH746	398	491
	97,5	82,5	60	IRBNH756	438	539
	107,5	82,5	60	IRBNH766	483	594
	117,5	82,5	60	IRBNH776	531	652
P 70	75	82,5	70	IRBNH747	422	516
	97,5	82,5	70	IRBNH757	464	566
	107,5	82,5	70	IRBNH767	510	624
	117,5	82,5	70	IRBNH777	562	688

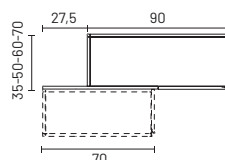
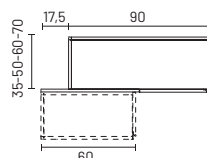
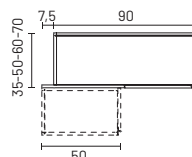
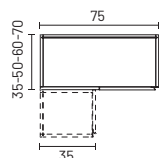

Sommare alla composizione il prezzo dello zoccolo o dei piedini H 6 cm (pagina 103).

Fianchi di serie in finitura materico avana. Maggiorazione per fianchi in finitura come il frontale a pagina 17-18.

Add the price of the plinth or H 6 cm feet to the composition (page 103).

Standard sides in Avana textured finish. Surcharge for sides in finish like the front on page 17-18.

BASI TERMINALI/DI RACCORDO H 82,5 cm

End/connecting base units h 82,5 cm

IDROBOX

1 anta

1 door

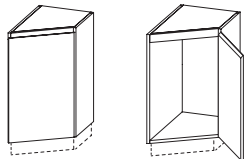

L W	H H	P D	CODICE CODE
--------	--------	--------	----------------

Materico Textured finish	Lacc. opaco Matt lacq.
-----------------------------	---------------------------

P 60 dx | rh

40	82,5	60	IRBT8726D
40	82,5	60	IRBT8726S

414	577
414	577

sx | lh

elemento a giorno terminale

end unit with open compartments

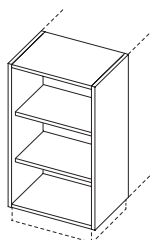

In finitura materico la schiena del vano è laccata opaco in tinta

In textured finishes, the back of the compartment is matt lacquered in a matching finish

L W	H H	P D	CODICE CODE
--------	--------	--------	----------------

Materico Textured finish	Lacc. opaco Matt lacq.
-----------------------------	---------------------------

P 18

50	82,5	18	IRBG0741
60	82,5	18	IRBG0761
70	82,5	18	IRBG0771

294	498
332	533
345	580

P 33

50	82,5	33	IRBG0742
60	82,5	33	IRBG0762
70	82,5	33	IRBG0772

316	520
354	549
372	603

Sommare alla composizione il prezzo dello zoccolo o dei piedini H 6 cm (pagina 103).

Fianchi di serie in finitura materico avana. Maggiorazione per fianchi in finitura come il frontale a pagina 17-18.

Add the price of the plinth or H 6 cm feet to the composition (page 103).

Standard sides in Avana textured finish. Surcharge for sides in finish like the front on page 17-18.

IDROBOX BASI
IDROBOX BASE UNITS

IDROBOX COLONNE E PENSILI
IDROBOX TALL AND WALL UNITS

IDROBOX ATTREZZATURA
IDROBOX EQUIPMENT

IDROBOX TOP E LAVATOI
IDROBOX TOPS AND WASHBASINS

INGRESSI
HALLWAY CABINETS

SCARPIERE
SHOE CABINETS

ACCESSORI
ACCESSORIES

BASI PORTALAVATRICE H 88,5 cm

Washing machine base units h 88,5 cm

IDROBOX

2 ante battenti

2 hinged doors

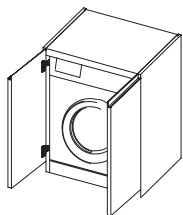

maniglia orizzontale o verticale
horizontal or vertical handle

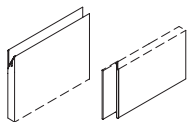

2 ante soffietto

2 folding doors

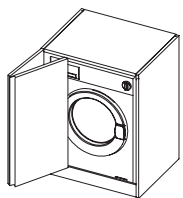

maniglia verticale
vertical handle

2 ante rientranti

2 pocket doors

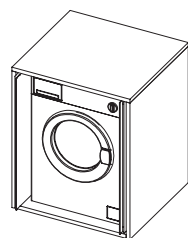

maniglia verticale
vertical handle

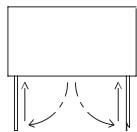

 = smontato
not assembled

L W	H H	P D	CODICE CODE
--------	--------	--------	----------------

Materico Textured finish	Lacc. opaco Matt lacq.
-----------------------------	---------------------------

P 60	75	88,5	60	IRBV9746
-------------	-----------	------	----	----------

505	592
------------	------------

P 70	75	88,5	70	IRBV9747
-------------	-----------	------	----	----------

521	612
------------	------------

L W	H H	P D	CODICE CODE
--------	--------	--------	----------------

Materico Textured finish	Lacc. opaco Matt lacq.
-----------------------------	---------------------------

P 60	75	88,5	60	IRBV8746
-------------	-----------	------	----	----------

707	829
------------	------------

P 70	75	88,5	70	IRBV8747
-------------	-----------	------	----	----------

729	856
------------	------------

L W	H H	P D	CODICE CODE
--------	--------	--------	----------------

Materico Textured finish	Lacc. opaco Matt lacq.
-----------------------------	---------------------------

P 50	80	88,5	50	IRBVR744
-------------	-----------	------	----	----------

720	899
------------	------------

P 60	80	88,5	60	IRBVR746
-------------	-----------	------	----	----------

754	933
------------	------------

P 70	80	88,5	70	IRBVR747
-------------	-----------	------	----	----------

799	975
------------	------------

Verificare sempre le dimensioni dell'elettrodomestico da inserire e l'ingombro di rubinetti e scarichi.
Fianchi di serie in finitura materico avana. Maggiorazione per fianchi in finitura come il frontale a pagina 17-18.
Maggiorazione per cerniera 180° su ante battenti € 15.
Maggiorazione per cerniera 270° su ante battenti € 19.

Always check the size of appliance, taps and drains.
Standard sides in Avana textured finish. Surcharge for sides in finish like the front on page 17-18.
Surcharge for 180° hinge on hinged doors € 15
Surcharge for 270° hinge on hinged doors € 19

COLONNE TALL UNITS	P. 44
COLONNE SPECIALI SPECIAL TALL UNITS	P. 52
COLONNE PORTALAVATRICE WASHING MACHINE TALL UNITS	P. 56
COLONNE CON SOPRALZO TALL UNITS WITH TOP UNIT	P. 61
ELEMENTI SOPRALZO TOP UNITS	P. 64
ELEMENTI A GIORNO OPEN COMPARTMENTS	P. 72
PENSILI WALL UNITS	P. 79

COLONNE A TERRA H 120 cm

Floor-standing tall units h 120 cm

IDROBOX

1 anta dx o sx

1 R or L door

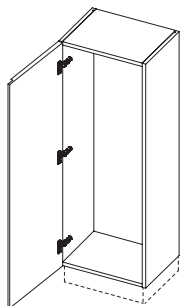

L W	H H	P D	CODICE CODE
--------	--------	--------	----------------

Materico Textured finish	Lacc. opaco Matt lacq.
-----------------------------	---------------------------

	L W	H H	P D	CODICE CODE	Materico Textured finish	Lacc. opaco Matt lacq.
P 35	30	120	35	IRC08A12	320	398
	45	120	35	IRC08A22	364	461
	60	120	35	IRC08A32	409	522
P 50	30	120	50	IRC08A14	334	415
	45	120	50	IRC08A24	382	480
	60	120	50	IRC08A34	427	545
P 60	30	120	60	IRC08A16	348	432
	45	120	60	IRC08A26	397	501
	60	120	60	IRC08A36	445	567
P 70	30	120	70	IRC08A17	362	450
	45	120	70	IRC08A27	413	520
	60	120	70	IRC08A37	463	590

2 ante

2 doors

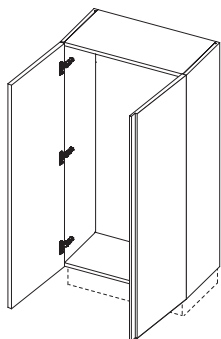

L W	H H	P D	CODICE CODE
--------	--------	--------	----------------

Materico Textured finish	Lacc. opaco Matt lacq.
-----------------------------	---------------------------

	L W	H H	P D	CODICE CODE	Materico Textured finish	Lacc. opaco Matt lacq.
P 35	60	120	35	IRC09A32	458	569
	75	120	35	IRC09A42	510	646
	90	120	35	IRC09A52	564	723
P 50	60	120	50	IRC09A34	478	594
	75	120	50	IRC09A44	534	675
	90	120	50	IRC09A54	590	756
P 60	60	120	60	IRC09A36	499	620
	75	120	60	IRC09A46	558	706
	90	120	60	IRC09A56	616	790
P 70	60	120	70	IRC09A37	520	646
	75	120	70	IRC09A47	580	735
	90	120	70	IRC09A57	641	822

Sommare alla composizione il prezzo dello zoccolo o dei piedini H 6 cm (pagina 103).

Fianchi di serie in finitura materico avana. Maggiorazione per fianchi in finitura come il frontale a pagina 17-18.

Maggiorazione per cerniera 180° su ante battenti € 15.

Add the price of the plinth or H 6 cm feet to the composition (page 103).

Standard sides in Avana textured finish. Surcharge for sides in finish like the front on page 17-18.

Surcharge for 180° hinge on hinged doors € 15

COLONNE A TERRA H 135 cm

Floor-standing tall units h 135 cm

IDROBOX

1 anta dx o sx

1 R or L door

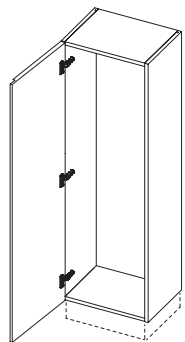

2 ante

2 doors

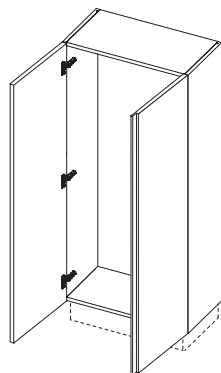

L W	H H	P D	CODICE CODE	Materico Textured finish	Lacc. opaco Matt lacq.
--------	--------	--------	----------------	-----------------------------	---------------------------

P 35	30	135	35	IRC08B12	328	408
	45	135	35	IRC08B22	372	472
	60	135	35	IRC08B32	417	536

P 50	30	135	50	IRC08B14	342	427
	45	135	50	IRC08B24	389	493
	60	135	50	IRC08B34	437	560

P 60	30	135	60	IRC08B16	357	445
	45	135	60	IRC08B26	405	516
	60	135	60	IRC08B36	456	584

P 70	30	135	70	IRC08B17	372	464
	45	135	70	IRC08B27	423	536
	60	135	70	IRC08B37	475	609

L W	H H	P D	CODICE CODE	Materico Textured finish	Lacc. opaco Matt lacq.
--------	--------	--------	----------------	-----------------------------	---------------------------

P 35	60	135	35	IRC09B32	465	579
	75	135	35	IRC09B42	520	658
	90	135	35	IRC09B52	574	736

P 50	60	135	50	IRC09B34	488	607
	75	135	50	IRC09B44	545	690
	90	135	50	IRC09B54	602	771

P 60	60	135	60	IRC09B36	509	634
	75	135	60	IRC09B46	569	721
	90	135	60	IRC09B56	629	807

P 70	60	135	70	IRC09B37	532	663
	75	135	70	IRC09B47	593	752
	90	135	70	IRC09B57	655	842

Sommare alla composizione il prezzo dello zoccolo o dei piedini H 6 cm (pagina 103).

Fianchi di serie in finitura materico avana. Maggiorazione per fianchi in finitura come il frontale a pagina 17-18.

Maggiorazione per cerniera 180° su ante battenti € 15.

Add the price of the plinth or H 6 cm feet to the composition (page 103).

Standard sides in Avana textured finish. Surcharge for sides in finish like the front on page 17-18.

Surcharge for 180° hinge on hinged doors € 15

IDROBOX BASI
IDROBOX BASE UNITS

IDROBOX COLONNE E PENSILI
IDROBOX TALL AND WALL UNITS

IDROBOX ATTREZZATURA
IDROBOX EQUIPMENT

IDROBOX TOP E LAVATOI
IDROBOX TOPS AND WASHBASINS

INGRESSI
HALLWAY CABINETS

SCARPIERE
SHOE CABINETS

ACCESSORI
ACCESSORIES

COLONNE A TERRA H 150 cm

Floor-standing tall units h 150 cm

IDROBOX

1 ante dx o sx

1 R or L door

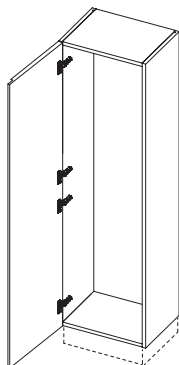

L W	H H	P D	CODICE CODE
--------	--------	--------	----------------

Materico Textured finish	Lacc. opaco Matt lacq.
-----------------------------	---------------------------

	L W	H H	P D	CODICE CODE	Materico Textured finish	Lacc. opaco Matt lacq.
P 35	30	150	35	IRC08C12	347	436
	45	150	35	IRC08C22	396	504
	60	150	35	IRC08C32	443	572
P 50	30	150	50	IRC08C14	362	456
	45	150	50	IRC08C24	413	528
	60	150	50	IRC08C34	464	598
P 60	30	150	60	IRC08C16	378	476
	45	150	60	IRC08C26	431	549
	60	150	60	IRC08C36	484	624
P 70	30	150	70	IRC08C17	394	495
	45	150	70	IRC08C27	449	573
	60	150	70	IRC08C37	504	650

2 ante

2 doors

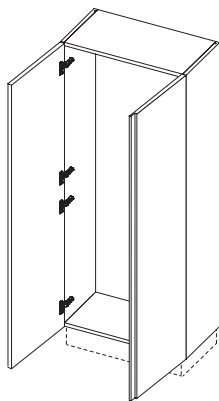

L W	H H	P D	CODICE CODE
--------	--------	--------	----------------

Materico Textured finish	Lacc. opaco Matt lacq.
-----------------------------	---------------------------

	L W	H H	P D	CODICE CODE	Materico Textured finish	Lacc. opaco Matt lacq.
P 35	60	150	35	IRC09C32	470	587
	75	150	35	IRC09C42	524	666
	90	150	35	IRC09C52	579	744
P 50	60	150	50	IRC09C34	493	616
	75	150	50	IRC09C44	550	698
	90	150	50	IRC09C54	609	781
P 60	60	150	60	IRC09C36	517	645
	75	150	60	IRC09C46	577	732
	90	150	60	IRC09C56	637	819
P 70	60	150	70	IRC09C37	539	674
	75	150	70	IRC09C47	603	765
	90	150	70	IRC09C57	666	856

Sommare alla composizione il prezzo dello zoccolo o dei piedini H 6 cm (pagina 103).

Fianchi di serie in finitura materico avana. Maggiorazione per fianchi in finitura come il frontale a pagina 17-18.

Maggiorazione per cerniera 180° su ante battenti € 15.

Add the price of the plinth or H 6 cm feet to the composition (page 103).

Standard sides in Avana textured finish. Surcharge for sides in finish like the front on page 17-18.

Surcharge for 180° hinge on hinged doors € 15

COLONNE A TERRA H 180 cm

Floor-standing tall units h 180 cm

IDROBOX

1 anta dx o sx

1 R or L door

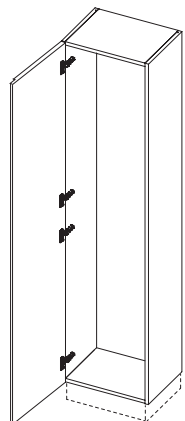

2 ante

2 doors

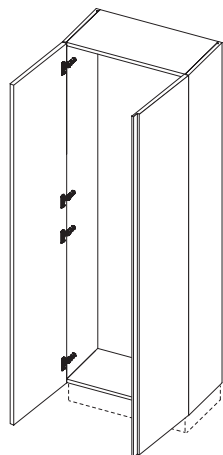

L W	H H	P D	CODICE CODE	Materico Textured finish	Lacc. opaco Matt lacq.
--------	--------	--------	----------------	-----------------------------	---------------------------

P 35	30	180	35	IRC08D12	396	493
	45	180	35	IRC08D22	450	569
	60	180	35	IRC08D32	490	573

P 50	30	180	50	IRC08D14	414	516
	45	180	50	IRC08D24	471	594
	60	180	50	IRC08D34	505	590

P 60	30	180	60	IRC08D16	431	537
	45	180	60	IRC08D26	491	620
	60	180	60	IRC08D36	520	607

P 70	30	180	70	IRC08D17	449	560
	45	180	70	IRC08D27	512	646
	60	180	70	IRC08D37	544	634

L W	H H	P D	CODICE CODE	Materico Textured finish	Lacc. opaco Matt lacq.
--------	--------	--------	----------------	-----------------------------	---------------------------

P 35	60	180	35	IRC09D32	538	661
	75	180	35	IRC09D42	602	750
	90	180	35	IRC09D52	647	829

P 50	60	180	50	IRC09D34	565	694
	75	180	50	IRC09D44	632	787
	90	180	50	IRC09D54	680	871

P 60	60	180	60	IRC09D36	592	727
	75	180	60	IRC09D46	661	825
	90	180	60	IRC09D56	711	912

P 70	60	180	70	IRC09D37	619	761
	75	180	70	IRC09D47	692	863
	90	180	70	IRC09D57	744	954

Sommare alla composizione il prezzo dello zoccolo o dei piedini H 6 cm (pagina 103).

Fianchi di serie in finitura materico avana. Maggiorazione per fianchi in finitura come il frontale a pagina 17-18.

Maggiorazione per cerniera 180° su ante battenti € 15.

Add the price of the plinth or H 6 cm feet to the composition (page 103).

Standard sides in Avana textured finish. Surcharge for sides in finish like the front on page 17-18.

Surcharge for 180° hinge on hinged doors € 15

IDROBOX BASI
IDROBOX BASE UNITS

IDROBOX COLONNE E PENSILI
IDROBOX TALL AND WALL UNITS

IDROBOX ATTREZZATURA
IDROBOX EQUIPMENT

IDROBOX TOP E LAVATOI
IDROBOX TOPS AND WASHBASINS

INGRESSI
HALLWAY CABINETS

SCARPIERE
SHOE CABINETS

ACCESSORI
ACCESSORIES

COLONNE A TERRA H 195 cm

Floor-standing tall units h 195 cm

IDROBOX

1 anta dx o sx

1 R or L door

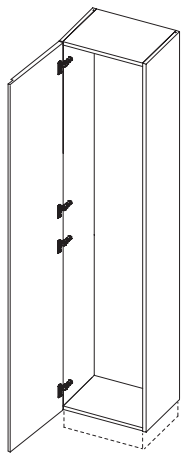

L W	H H	P D	CODICE CODE
--------	--------	--------	----------------

Materico Textured finish	Lacc. opaco Matt lacq.
-----------------------------	---------------------------

	L W	H H	P D	CODICE CODE	Materico Textured finish	Lacc. opaco Matt lacq.
P 35	30	195	35	IRC08E12	408	504
	45	195	35	IRC08E22	464	579
	60	195	35	IRC08E32	546	636
P 50	30	195	50	IRC08E14	426	525
	45	195	50	IRC08E24	485	606
	60	195	50	IRC08E34	563	655
P 60	30	195	60	IRC08E16	444	549
	45	195	60	IRC08E26	506	633
	60	195	60	IRC08E36	579	675
P 70	30	195	70	IRC08E17	463	573
	45	195	70	IRC08E27	528	659
	60	195	70	IRC08E37	605	706

2 ante

2 doors

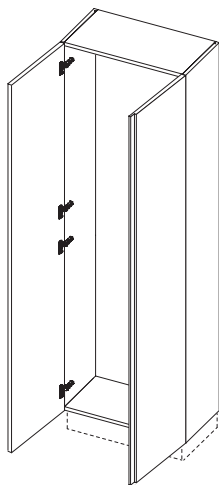

L W	H H	P D	CODICE CODE
--------	--------	--------	----------------

Materico Textured finish	Lacc. opaco Matt lacq.
-----------------------------	---------------------------

	L W	H H	P D	CODICE CODE	Materico Textured finish	Lacc. opaco Matt lacq.
P 35	60	195	35	IRC09E32	560	677
	75	195	35	IRC09E42	624	765
	90	195	35	IRC09E52	673	855
P 50	60	195	50	IRC09E34	587	710
	75	195	50	IRC09E44	655	804
	90	195	50	IRC09E54	707	898
P 60	60	195	60	IRC09E36	615	742
	75	195	60	IRC09E46	685	842
	90	195	60	IRC09E56	740	940
P 70	60	195	70	IRC09E37	642	777
	75	195	70	IRC09E47	718	881
	90	195	70	IRC09E57	773	983

Sommare alla composizione il prezzo dello zoccolo o dei piedini H 6 cm (pagina 103).

Fianchi di serie in finitura materico avana. Maggiorazione per fianchi in finitura come il frontale a pagina 17-18.

Maggiorazione per cerniera 180° su ante battenti € 15.

Add the price of the plinth or H 6 cm feet to the composition (page 103).

Standard sides in Avana textured finish. Surcharge for sides in finish like the front on page 17-18.

Surcharge for 180° hinge on hinged doors € 15

COLONNE ANGOLO H 195 cm

Corner tall units h 195 cm

IDROBOX

1 anta dx o sx (scocca vuota)

1 R or L door (empty structure)

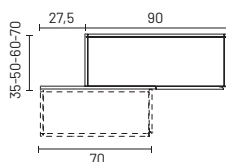
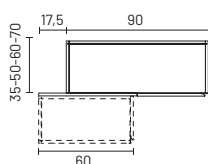
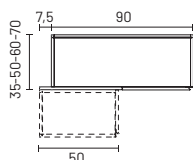
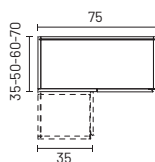
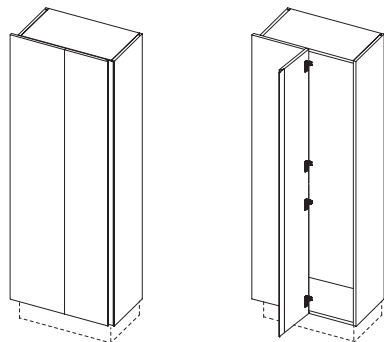

L W	H H	P D	CODICE CODE
--------	--------	--------	----------------

Materico Textured finish	Lacc. opaco Matt lacq.
-----------------------------	---------------------------

	L W	H H	P D	CODICE CODE	Materico Textured finish	Lacc. opaco Matt lacq.
P 35	75	195	35	IRCOHE42	652	1.132
	97,5	195	35	IRCOHE52	711	1.261
	107,5	195	35	IRCOHE62	775	1.373
	117,5	195	35	IRCOHE72	837	1.483
P 50	75	195	50	IRCOHE44	694	1.250
	97,5	195	50	IRCOHE54	758	1.387
	107,5	195	50	IRCOHE64	825	1.509
	117,5	195	50	IRCOHE74	889	1.631
P 60	75	195	60	IRCOHE46	737	1.370
	97,5	195	60	IRCOHE56	804	1.516
	107,5	195	60	IRCOHE66	873	1.647
	117,5	195	60	IRCOHE76	944	1.781
P 70	75	195	70	IRCOHE47	779	1.490
	97,5	195	70	IRCOHE57	850	1.643
	107,5	195	70	IRCOHE67	926	1.789
	117,5	195	70	IRCOHE77	1.117	1.934

Sommare alla composizione il prezzo dello zoccolo o dei piedini H 6 cm (pagina 103).
Fianchi di serie in finitura materico avana. Maggiorazione per fianchi in finitura come il frontale a pagina 17-18.

Add the price of the plinth or H 6 cm feet to the composition (page 103).
Standard sides in Avana textured finish. Surcharge for sides in finish like the front on page 17-18.

IDROBOX BASI
IDROBOX BASE UNITS

IDROBOX COLONNE E PENSILI
IDROBOX TALL AND WALL UNITS

IDROBOX ATTREZZATURA
IDROBOX EQUIPMENT

IDROBOX TOP E LAVATOI
IDROBOX TOPS AND WASHBASINS

INGRESSI
HALLWAY CABINETS

SCARPIERE
SHOE CABINETS

ACCESSORI
ACCESSORIES

COLONNE TERMINALI H 195 cm

End tall units h 195 cm

IDROBOX

vano a giorno
open compartment

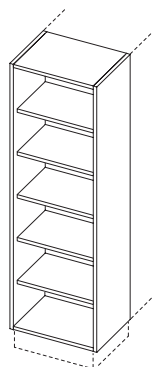

5 ripiani
In finitura materico la schiena del vano è laccata opaco in tinta
5 shelves
In textured finishes, the back of the compartment is matt lacquered in a matching finish

L W	H H	P D	CODICE CODE
--------	--------	--------	----------------

Materico Textured finish	Lacc. opaco Matt lacq.
-----------------------------	---------------------------

P 18

50	195	18	IRCG0E41
60	195	18	IRCG0E61
70	195	18	IRCG0E71

502	771
563	848
592	887

P 33

50	195	33	IRCG0E42
60	195	33	IRCG0E62
70	195	33	IRCG0E72

535	805
598	882
631	931

Sommare alla composizione il prezzo dello zoccolo o dei piedini H 6 cm (pagina 103).

Add the price of the plinth or H 6 cm feet to the composition (page 103).

COLONNE A TERRA H 210 cm

Floor-standing tall units h 210 cm

IDROBOX

1 anta dx o sx

1 R or L door

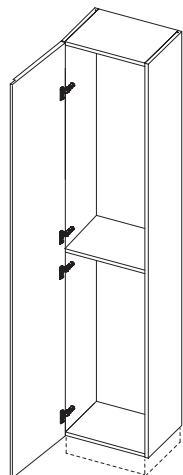

2 ante

2 doors

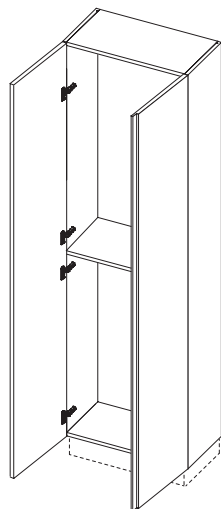

L W	H H	P D	CODICE CODE	Materico Textured finish	Lacc. opaco Matt lacq.
--------	--------	--------	----------------	-----------------------------	---------------------------

P 35	30	210	35	IRC08F12	450	561
	45	210	35	IRC08F22	513	647
	60	210	35	IRC08F32	575	734

P 50	30	210	50	IRC08F14	471	587
	45	210	50	IRC08F24	535	677
	60	210	50	IRC08F34	601	766

P 60	30	210	60	IRC08F16	491	612
	45	210	60	IRC08F26	559	707
	60	210	60	IRC08F36	627	800

P 70	30	210	70	IRC08F17	512	638
	45	210	70	IRC08F27	582	736
	60	210	70	IRC08F37	653	834

L W	H H	P D	CODICE CODE	Materico Textured finish	Lacc. opaco Matt lacq.
--------	--------	--------	----------------	-----------------------------	---------------------------

P 35	60	210	35	IRC09F32	618	753
	75	210	35	IRC09F42	690	854
	90	210	35	IRC09F52	748	934

P 50	60	210	50	IRC09F34	648	791
	75	210	50	IRC09F44	724	897
	90	210	50	IRC09F54	785	981

P 60	60	210	60	IRC09F36	680	829
	75	210	60	IRC09F46	758	940
	90	210	60	IRC09F56	822	1.028

P 70	60	210	70	IRC09F37	710	867
	75	210	70	IRC09F47	793	982
	90	210	70	IRC09F57	859	1.074

Sommare alla composizione il prezzo dello zoccolo o dei piedini H 6 cm (pagina 103).

Fianchi di serie in finitura materico avana. Maggiorazione per fianchi in finitura come il frontale a pagina 17-18.

Maggiorazione per cerniera 180° su ante battenti € 15.

Add the price of the plinth or H 6 cm feet to the composition (page 103).

Standard sides in Avana textured finish. Surcharge for sides in finish like the front on page 17-18.

Surcharge for 180° hinge on hinged doors € 15

IDROBOX BASI
IDROBOX BASE UNITS

IDROBOX COLONNE E PENSILI
IDROBOX TALL AND WALL UNITS

IDROBOX ATTREZZATURA
IDROBOX EQUIPMENT

IDROBOX TOP E LAVATOI
IDROBOX TOPS AND WASHBASINS

INGRESSI
HALLWAY CABINETS

SCARPIERE
SHOE CABINETS

ACCESSORI
ACCESSORIES

COLONNE SPECIALI H 195 cm

Special tall units h 195 cm

IDROBOX

1 anta dx o sx + ribalta per portabiancheria

1 R or L door + tilt door for laundry basket

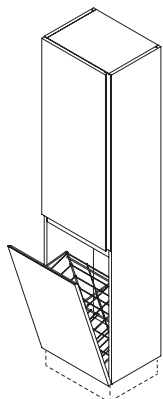

la dimensione del cesto rimane invariata in entrambe le profondità.
the size of the basket is the same in both depths.

L W	H H	P D	CODICE CODE
--------	--------	--------	----------------

Materico Textured finish	Lacc. opaco Matt lacq.
-----------------------------	---------------------------

P 35

45	195	35	IRCOCE22
60	195	35	IRCOCE32

685	801
767	857

P 60

45	195	60	IRCOCE26
60	195	60	IRCOCE36

726	842
808	897

1 anta dx o sx + cestone estraibile con portabiancheria

1 R or L door + pull-out deep drawer with laundry basket

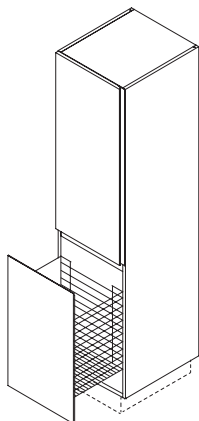

L W	H H	P D	CODICE CODE
--------	--------	--------	----------------

Materico Textured finish	Lacc. opaco Matt lacq.
-----------------------------	---------------------------

P 60

45	195	60	IRCODE26
60	195	60	IRCODE36

798	925
871	967

Sommare alla composizione il prezzo dello zoccolo o dei piedini H 6 cm (pagina 103).

Fianchi di serie in finitura materico avana. Maggiorazione per fianchi in finitura come il frontale a pagina 17-18.

Maggiorazione per cerniera 180° su ante battenti € 15.

Add the price of the plinth or H 6 cm feet to the composition (page 103).

Standard sides in Avana textured finish. Surcharge for sides in finish like the front on page 17-18.

Surcharge for 180° hinge on hinged doors € 15

COLONNE SPECIALI H 195 cm

Special tall units h 195 cm

IDROBOX

1 anta dx o sx + 2 ribalte per portabiancheria

1 R or L door + 2 tilt doors for laundry basket

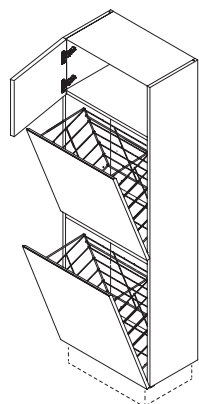

la dimensione del cesto rimane invariata in entrambe le profondità.
the size of the basket is the same in both depths.

1 anta dx o sx + asse da stiro

1 R or L door + ironing board

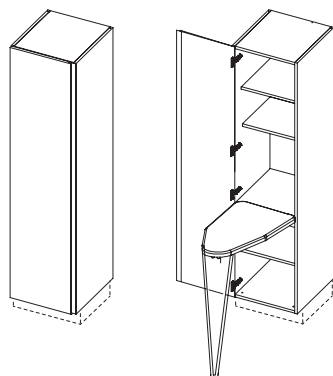

cerniere con apertura a 270° e copriasse inclusi
270° hinges and ironing board cover included

optional luce LED con sensore

optional LED with sensor

LED 3000 K, posizionato sul coperchio, accensione tramite sensore; alimentatore incluso
3000 K LED, on top sensor ON/OFF; power supply included

copriasse di ricambio

spare ironing board cover

L W	H H	P D	CODICE CODE	Materico Textured finish	Lacc. opaco Matt lacq.
--------	--------	--------	----------------	-----------------------------	---------------------------

P 35	60	195	35	IRCOEE32	925	1.320
------	----	-----	----	----------	-----	-------

P 60	60	195	60	IRCOEE36	980	1.559
------	----	-----	----	----------	-----	-------

L W	H H	P D	CODICE CODE	Materico Textured finish	Lacc. opaco Matt lacq.
--------	--------	--------	----------------	-----------------------------	---------------------------

P 35	45	195	35	IRCOSE22	849	1.341
------	----	-----	----	----------	-----	-------

P 50	45	195	50	IRCOSE24	898	1.389
------	----	-----	----	----------	-----	-------

P 60	45	195	60	IRCOSE26	934	1.424
------	----	-----	----	----------	-----	-------

P 70	45	195	70	IRCOSE27	970	1.461
------	----	-----	----	----------	-----	-------

Watt Watt	CODICE CODE	Prezzo Price
--------------	----------------	-----------------

6	MGLE02	116
---	--------	-----

CODICE CODE	Prezzo Price
----------------	-----------------

UMGCAS02	30
----------	----

Sommare alla composizione il prezzo dello zoccolo o dei piedini H 6 cm (pagina 103).
Fianchi di serie in finitura materico avana. Maggiorazione per fianchi in finitura come il frontale a pagina 17-18.

Add the price of the plinth or H 6 cm feet to the composition (page 103).
Standard sides in Avana textured finish. Surcharge for sides in finish like the front on page 17-18.

IDROBOX BASI
IDROBOX BASE UNITS

IDROBOX COLONNE E PENSILI
IDROBOX TALL AND WALL UNITS

IDROBOX ATTREZZATURA
IDROBOX EQUIPMENT

IDROBOX TOP E LAVATOI
IDROBOX TOPS AND WASHBASINS

INGRESSI
HALLWAY CABINETS

SCARPIERE
SHOE CABINETS

ACCESSORI
ACCESSORIES

COLONNE SPECIALI H 195 cm

Special tall units h 195 cm

IDROBOX

2 ante + vano portascoppe e 4 ripiani

2 doors + broom storage compartment and 4 shelves

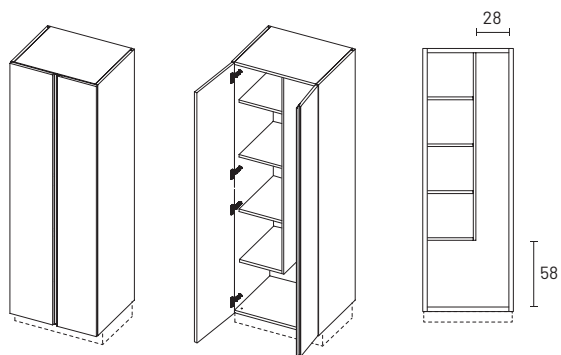

L W	H H	P D	CODICE CODE	Materico Textured finish	Lacc. opaco Matt lacq.
--------	--------	--------	----------------	-----------------------------	---------------------------

P 35	60	195	35	IRCOPE32	665	781
	75	195	35	IRCOPE42	728	870
P 50	60	195	50	IRCOPE34	692	815
	75	195	50	IRCOPE44	761	909
P 60	60	195	60	IRCOPE36	720	848
	75	195	60	IRCOPE46	791	947
P 70	60	195	70	IRCOPE37	748	882
	75	195	70	IRCOPE47	822	985

2 ante + ripiano fisso e divisione

2 doors + fixed shelf and partition

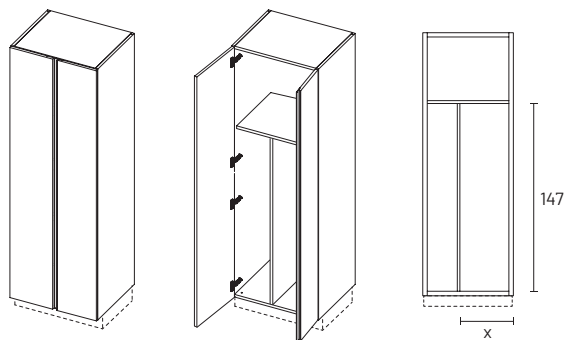

L W	H H	P D	CODICE CODE	Materico Textured finish	Lacc. opaco Matt lacq.
--------	--------	--------	----------------	-----------------------------	---------------------------

P 50	60	195	50	IRCORE34	645	768
	75	195	50	IRCORE44	725	909
	90	195	50	IRCORE54	805	1.049
P 60	60	195	60	IRCORE36	673	801
	75	195	60	IRCORE46	755	947
	90	195	60	IRCORE56	839	1.092
P 70	60	195	70	IRCORE37	700	835
	75	195	70	IRCORE47	787	985
	90	195	70	IRCORE57	873	1.134

indicare la posizione della divisione e dei ripiani optional
indicate the position of the partition and optional shelves

ripiano optional su misura

optional custom shelf



SP TH	P D	CODICE CODE	Materico Textured finish
----------	--------	----------------	-----------------------------

P 50	1,8	50	IRRR0054	24
P 60	1,8	60	IRRR0055	25
P 70	1,8	70	IRRR0056	27

Sommare alla composizione il prezzo dello zoccolo o dei piedini H 6 cm (pagina 103).

Fianchi di serie in finitura materico avana. Maggiorazione per fianchi in finitura come il frontale a pagina 17-18.

Maggiorazione per cerniera 180° su ante battenti € 15.

Add the price of the plinth or H 6 cm feet to the composition (page 103).

Standard sides in Avana textured finish. Surcharge for sides in finish like the front on page 17-18. Surcharge for 180° hinge on hinged doors € 15

COLONNE SPECIALI H 195 cm

Special tall units h 195 cm

IDROBOX

2 ante e lavatoio

2 door and washbasin

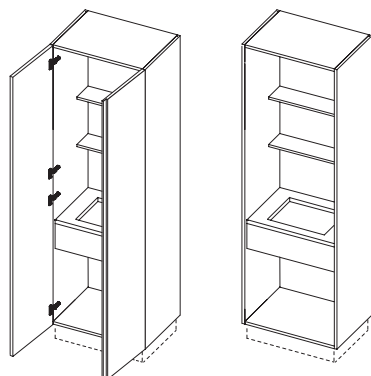

compreso di top sp. 4 cm, pannello frontale copri vasca, 2 ripiani sp. 1,8 cm, cerniere con apertura a 180°
including 4 cm th top, front cover panel, 2 x 1,8 cm th shelves, 180° hinges

optional luce LED

optional LED

LED 3000 K; posizionato sul coperchio, accensione tramite interruttore a parete o dimmer + telecomando (pagina 110); alimentatore incluso (posizionamento a cura del cliente)

3000 K LED, on top, wall switch or dimmer ON/OFF + remote control (page 110); power supply included (installation is the customer's responsibility)

Lavatoi utilizzabili:

Compatible washbasins:

METACRILATO METHACRYLATE	MARMO MINERALE MINERAL MARBLE			CERAMICA CERAMIC
cod. U84010	cod. U85000	cod. U85010	cod. U85020	cod. U85530

P 60	solo con miscelatore a parete only with wall-mounted mixer tap	-	si yes	-	-
P 70	si yes	si yes	si yes	si yes	si yes

L W	H H	P D	CODICE CODE	Materico Textured finish	Lacc. opaco Matt lacq.
--------	--------	--------	----------------	-----------------------------	---------------------------

P 60	75	195	60	IRCOLE46	967	1.165
	90	195	60	IRCOLE56	1.043	1.325

P 70	75	195	70	IRCOLE47	997	1.224
	90	195	70	IRCOLE57	1.076	1.367

L W	Watt Watt	CODICE CODE	Prezzo Price
--------	--------------	----------------	-----------------

75	11	MGLED11	189
90	13	MGLED12	200

Sommare alla composizione il prezzo dello zoccolo o dei piedini H 6 cm (pagina 103).

Fianchi di serie in finitura materico avana. Maggiorazione per fianchi in finitura come il frontale a pagina 17-18.

Add the price of the plinth or H 6 cm feet to the composition (page 103).

Standard sides in Avana textured finish. Surcharge for sides in finish like the front on page 17-18.

IDROBOX BASI
IDROBOX BASE UNITS

IDROBOX COLONNE E PENSILI
IDROBOX TALL AND WALL UNITS

IDROBOX ATTREZZATURA
IDROBOX EQUIPMENT

IDROBOX TOP E LAVATOI
IDROBOX TOPS AND WASHBASINS

INGRESSI
HALLWAY CABINETS

SCARPIERE
SHOE CABINETS

ACCESSORI
ACCESSORIES

COLONNE PORTALAVATRICE H 201 cm

Washing machine tall units h 201 cm

IDROBOX

2 ante (vano lavatrice + asciugatrice sovrapposte)

2 doors (compartment for stacked washer + dryer)

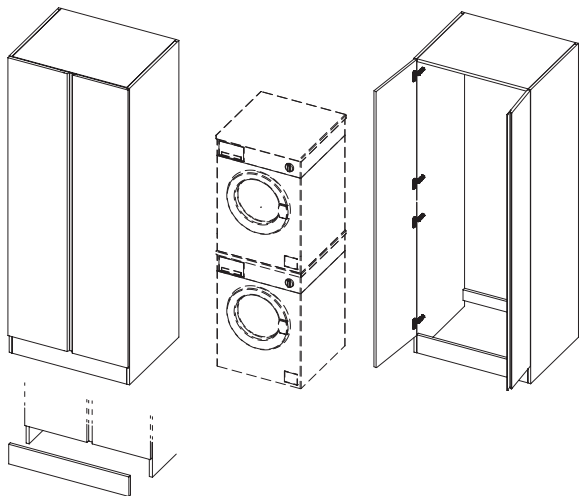

zoccolo compreso, fianchi a terra
including plinth, floor-standing sides

L W	H H	P D	CODICE CODE
--------	--------	--------	----------------

Materico Textured finish	Lacc. opaco Matt lacq.
-----------------------------	---------------------------

P 60	75	201	60	IRCV1E46
-------------	-----------	-----	----	----------

799	1.429
------------	--------------

P 70	75	201	70	IRCV1E47
-------------	-----------	-----	----	----------

877	1.572
------------	--------------

2 ante (vano lavatrice + asciugatrice)

2 doors (washer + dryer compartment)

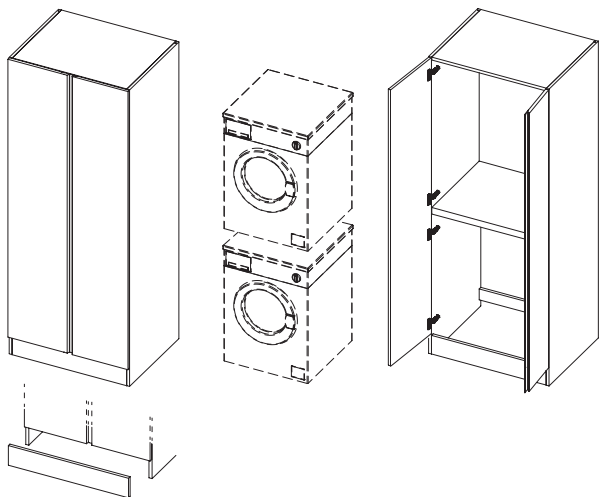

1 ripiano sp. 4 cm, zoccolo compreso, fianchi a terra
1 shelf th 4 cm, including plinth, floor-standing sides

L W	H H	P D	CODICE CODE
--------	--------	--------	----------------

Materico Textured finish	Lacc. opaco Matt lacq.
-----------------------------	---------------------------

P 60	75	201	60	IRCV2E46
-------------	-----------	-----	----	----------

873	1.571
------------	--------------

P 70	75	201	70	IRCV2E47
-------------	-----------	-----	----	----------

963	1.728
------------	--------------

Verificare sempre le dimensioni dell'elettrodomestico da inserire e l'ingombro di rubinetti e scarichi.
Fianchi di serie in finitura materico avana. Maggiorazione per fianchi in finitura come il frontale a pagina 17-18.
Maggiorazione per cerniera 180° su ante battenti + € 15 (comporta una riduzione del vano utile a 56 cm).
Maggiorazione per cerniera 270° su ante battenti + € 19.

Always check the size of appliance, taps and drains.
Standard sides in Avana textured finish. Surcharge for sides in finish like the front on page 17-18.
Surcharge for 180° hinge on hinged doors + € 15 (reduces the usable space to 56 cm).
Surcharge for 270° hinge on hinged doors + € 19.

COLONNE PORTALAVATRICE H 201 cm

Washing machine tall units h 201 cm

IDROBOX

2 ante (vano lavatrice + ripiani)

2 doors (washer compartment + shelves)

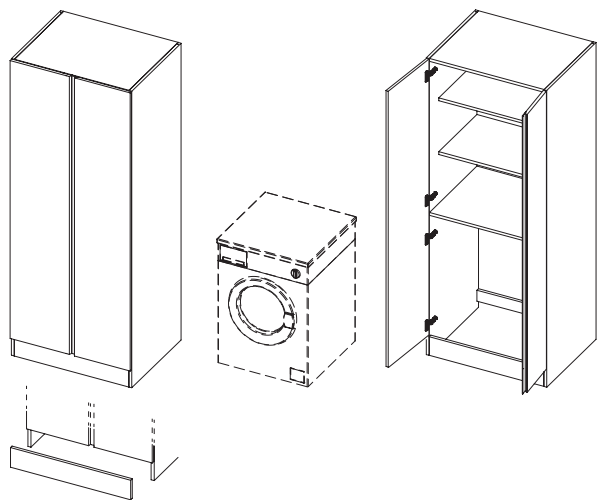

3 ripiani, zoccolo compreso, fianchi a terra

3 shelves, including plinth, floor-standing sides

L W	H H	P D	CODICE CODE
--------	--------	--------	----------------

Materico Textured finish	Lacc. opaco Matt lacq.
-----------------------------	---------------------------

P 60	75	201	60	IRCV3E46
------	----	-----	----	----------

873	1.571
-----	-------

P 70	75	201	70	IRCV3E47
------	----	-----	----	----------

963	1.728
-----	-------

Verificare sempre le dimensioni dell'elettrodomestico da inserire e l'ingombro di rubinetti e scarichi.
Fianchi di serie in finitura materico avana. Maggiorazione per fianchi in finitura come il frontale a pagina 17-18.
Maggiorazione per cerniera 180° su ante battenti + € 15 (comporta una riduzione del vano utile a 56 cm).
Maggiorazione per cerniera 270° su ante battenti + € 19.

Always check the size of appliance, taps and drains.
 Standard sides in Avana textured finish. Surcharge for sides in finish like the front on page 17-18.
 Surcharge for 180° hinge on hinged doors + € 15 (reduces the usable space to 56 cm).
 Surcharge for 270° hinge on hinged doors + € 19.

IDROBOX BASI
IDROBOX BASE UNITS

IDROBOX COLONNE E PENSILI
IDROBOX TALL AND WALL UNITS

IDROBOX ATTREZZATURA
IDROBOX EQUIPMENT

IDROBOX TOP E LAVATOI
IDROBOX TOPS AND WASHBASINS

INGRESSI
HALLWAY CABINETS

SCARPIERE
SHOE CABINETS

ACCESSORI
ACCESSORIES

COLONNE PORTALAVATRICE CON ANTE SOFFIETTO H 201 cm

Washing machine tall units with folding doors h 201 cm

IDROBOX

2 ante soffietto (vano lavatrice + asciugatrice sovrapposte)

2 folding doors (stacked washer + dryer compartment)

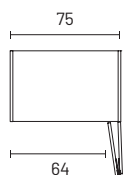
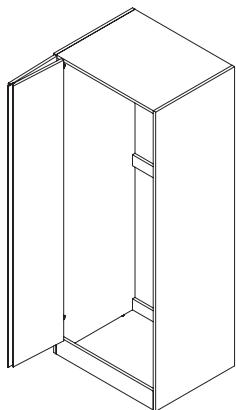

zoccolo compreso, fianchi a terra
including plinth, floor-standing sides

L W	H H	P D	CODICE CODE
--------	--------	--------	----------------

Materico Textured finish	Lacc. opaco Matt lacq.
-----------------------------	---------------------------

P 60	75	201	60	IRCV4E46
-------------	-----------	-----	----	----------

982	1.611
------------	--------------

P 70	75	201	70	IRCV4E47
-------------	-----------	-----	----	----------

1.060	1.753
--------------	--------------

2 ante soffietto (vano lavatrice + asciugatrice)

2 folding doors (washer + dryer compartment)

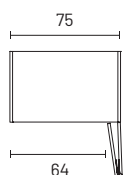
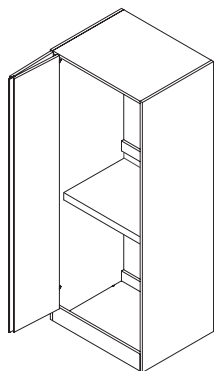

1 ripiano sp. 4 cm, zoccolo compreso, fianchi a terra
1 shelf th 4 cm, including plinth, floor-standing sides

L W	H H	P D	CODICE CODE
--------	--------	--------	----------------

Materico Textured finish	Lacc. opaco Matt lacq.
-----------------------------	---------------------------

P 60	75	201	60	IRCV5E46
-------------	-----------	-----	----	----------

1.058	1.749
--------------	--------------

P 70	75	201	70	IRCV5E47
-------------	-----------	-----	----	----------

1.147	1.907
--------------	--------------

Verificare sempre le dimensioni dell'elettrodomestico da inserire e l'ingombro di rubinetti e scarichi.
Fianchi di serie in finitura materico avana. Maggiorazione per fianchi in finitura come il frontale a pagina 17-18.

Always check the size of appliance, taps and drains.
Standard sides in Avana textured finish. Surcharge for sides in finish like the front on page 17-18.

COLONNE PORTALAVATRICE CON ANTE SOFFIETTO H 201 cm

Washing machine tall units with folding doors h 201 cm

IDROBOX

2 ante soffietto (vano lavatrice + ripiani)

2 folding doors (washer + shelves)

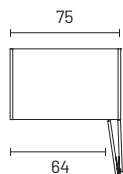
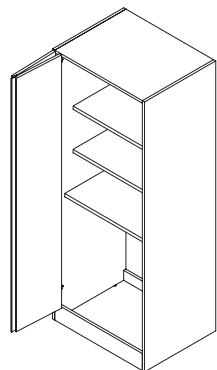

3 ripiani sp. 1,8 cm, zoccolo compreso, fianchi a terra
3 shelves th 1,8 cm, including plinth, floor-standing sides

L W	H H	P D	CODICE CODE
--------	--------	--------	----------------

Materico Textured finish	Lacc. opaco Matt lacq.
-----------------------------	---------------------------

P 60	75	201	60	IRCV6E46
-------------	-----------	-----	----	----------

1.060	1.753
--------------	--------------

P 70	75	201	70	IRCV6E47
-------------	-----------	-----	----	----------

1.147	1.907
--------------	--------------

Verificare sempre le dimensioni dell'elettrodomestico da inserire e l'ingombro di rubinetti e scarichi.
Fianchi di serie in finitura materico avana. Maggiorazione per fianchi in finitura come il frontale a pagina 17-18.

Always check the size of appliance, taps and drains.
Standard sides in Avana textured finish. Surcharge for sides in finish like the front on page 17-18.

IDROBOX BASI
IDROBOX BASE UNITS

IDROBOX COLONNE E PENSILI
IDROBOX TALL AND WALL UNITS

IDROBOX ATTREZZATURA
IDROBOX EQUIPMENT

IDROBOX TOP E LAVATOI
IDROBOX TOPS AND WASHBASINS

INGRESSI
HALLWAY CABINETS

SCARPIERE
SHOE CABINETS

ACCESSORI
ACCESSORIES

COLONNE PORTALAVATRICE CON ANTE RIENTRANTI H 201 cm

Washing machine tall units with pocket doors h 201 cm

IDROBOX

2 ante rientranti (vano lavatrice + ripiani)

2 pocket doors (washer compartment + shelves)

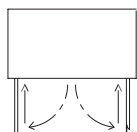
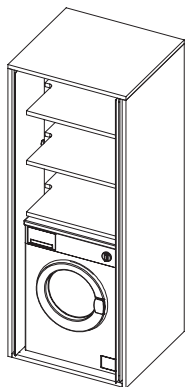

 = smontato
not assembled

L W	H H	P D	CODICE CODE
--------	--------	--------	----------------

Materico Textured finish	Lacc. opaco Matt lacq.
-----------------------------	---------------------------

P 60	80	201	60	IRCV8E46
-------------	-----------	-----	----	----------

1.260	2.238
--------------	--------------

P 70	80	201	70	IRCV8E47
-------------	-----------	-----	----	----------

1.293	2.292
--------------	--------------

2 ante rientranti (vano lavatrice + asciugatrice sovrapposte)

2 pocket doors (compartment for stacked washer + dryer)

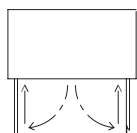
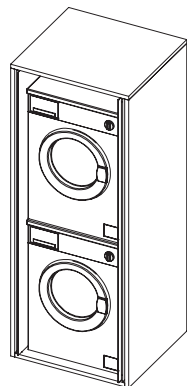

 = smontato
not assembled

L W	H H	P D	CODICE CODE
--------	--------	--------	----------------

Materico Textured finish	Lacc. opaco Matt lacq.
-----------------------------	---------------------------

P 60	80	201	60	IRCV9E46
-------------	-----------	-----	----	----------

1.508	2.534
--------------	--------------

P 70	80	201	70	IRCV9E47
-------------	-----------	-----	----	----------

1.597	2.592
--------------	--------------

Verificare sempre le dimensioni dell'elettrodomestico da inserire e l'ingombro di rubinetti e scarichi.

Always check the size of appliance, taps and drains.

COLONNE CON SOPRALZO E ANTA UNICA

Tall units with top unit and single door

IDROBOX

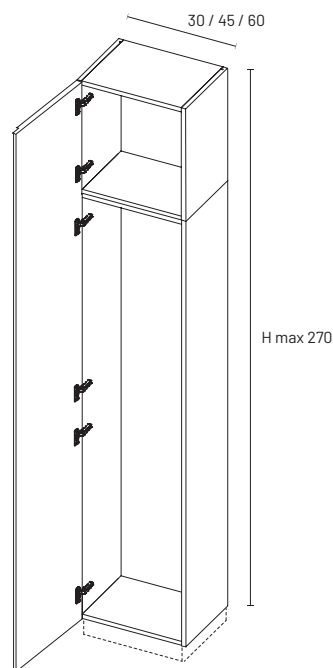
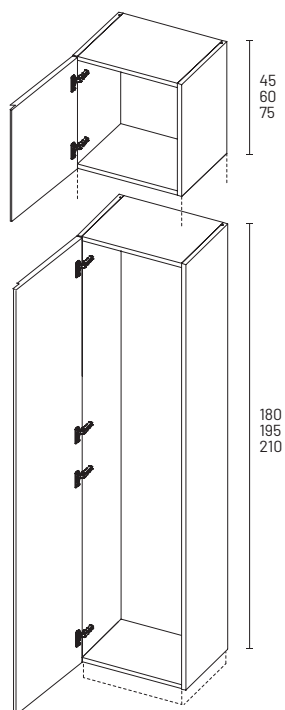

anta dx o sx con maniglia
R or L door with handle

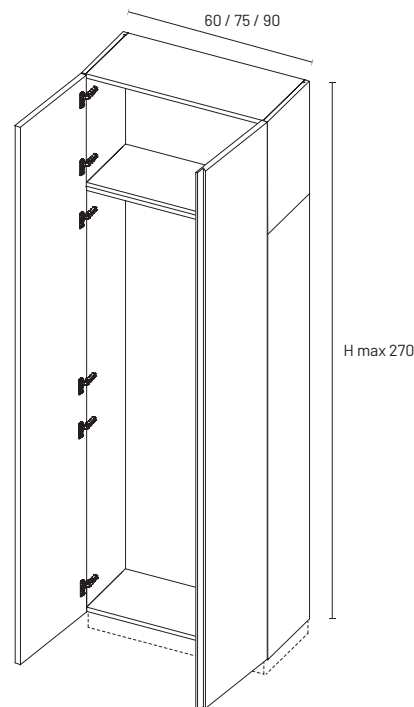

anta sx senza maniglia + anta dx con maniglia
L door without handle + R door with handle

Sovrapposizione di una colonna a terra e un elemento sopralzo con frontale unico (H massima 270 cm). Per calcolare il prezzo è necessario sottrarre ai due moduli il prezzo della loro anta e aggiungere il prezzo dell'anta di altezza totale (ottenuta dalla somma di colonna e sopralzo).

Nel caso di colonne a due ante si ricorda che per l'anta destra va considerato il prezzo con la maniglia mentre l'anta sinistra è senza maniglia.

Non è possibile realizzare un'anta unica nel caso di colonna angolo + sopralzo angolo, colonna attrezzata con asse da stiro, colonne con ante soffietto o rientranti.

Colonne, elementi sopralzo e ante vengono spediti in colli distinti

Stacked floor-standing tall unit and top unit with a single front (maximum H 270 cm). To calculate the price, subtract the price of the doors from the price of the two units and add the price of the full-height door (tall unit + top unit).

With two door tall units, take the price of the right door with a handle and the left without. Single doors cannot be created for corner tall unit + corner top unit, tall units with ironing board or tall units with folding or pocket doors.

Tall units, top unit and doors are shipped in separate packages.

PREZZO TOTALE = **colonna (-prezzo anta)** + **elemento sopralzo (-prezzo anta)** + **anta singola**
TOTAL PRICE = tall unit (- door price) + top unit (- door price) + single door

IDROBOX BASI
IDROBOX BASE UNITS

IDROBOX COLONNE E PENSILI
IDROBOX TALL AND WALL UNITS

IDROBOX ATTREZZATURA
IDROBOX EQUIPMENT

IDROBOX TOP E LAVATOI
IDROBOX TOPS AND WASHBASINS

INGRESSI
HALLWAY CABINETS

SCARPIERE
SHOE CABINETS

ACCESSORI
ACCESSORIES

COLONNE CON SOPRALZO E ANTA UNICA

Tall units with top unit and single door

IDROBOX

anta singola battente dx o sx con maniglia

R or L single hinged door with handle



	L W	H H	SP TH	CODICE CODE	Materico Textured finish	Lacc. opaco Matt lacq.		L W	H H	SP TH	CODICE CODE	Materico Textured finish	Lacc. opaco Matt lacq.
H 45	29,6	45	1,8	IRAS0411	11	23	H 210	29,6	210	1,8	IRAS0F11	48	106
	37,1	45	1,8	IRAS0421	13	29		37,1	210	1,8	IRAS0F21	61	133
	44,6	45	1,8	IRAS0431	17	35		44,6	210	1,8	IRAS0F31	72	159
	59,6	45	1,8	IRAS0441	21	47		59,6	210	1,8	IRAS0F41	96	212
H 60	29,6	60	1,8	IRAS0511	15	32	H 225	29,6	225	1,8	IRAS0G11	51	114
	37,1	60	1,8	IRAS0521	18	38		37,1	225	1,8	IRAS0G21	64	142
	44,6	60	1,8	IRAS0531	21	47		44,6	225	1,8	IRAS0G31	77	171
	59,6	60	1,8	IRAS0541	27	62		59,6	225	1,8	IRAS0G41	102	227
H 75	29,6	75	1,8	IRAS0611	18	38	H 240	29,6	240	1,8	IRAS0H11	54	121
	37,1	75	1,8	IRAS0621	22	48		37,1	240	1,8	IRAS0H21	69	152
	44,6	75	1,8	IRAS0631	26	58		44,6	240	1,8	IRAS0H31	83	182
	59,6	75	1,8	IRAS0641	35	77		59,6	240	1,8	IRAS0H41	110	242
H 180	29,6	180	1,8	IRAS0D11	42	91	H 255	29,6	255	1,8	IRAS0I11	58	128
	37,1	180	1,8	IRAS0D21	51	114		37,1	255	1,8	IRAS0I21	72	160
	44,6	180	1,8	IRAS0D31	62	137		44,6	255	1,8	IRAS0I31	87	194
	59,6	180	1,8	IRAS0D41	83	183		59,6	255	1,8	IRAS0I41	116	258
H 195	29,6	195	1,8	IRAS0E11	46	99	H 270	29,6	270	1,8	IRAS0L11	62	137
	37,1	195	1,8	IRAS0E21	56	124		37,1	270	1,8	IRAS0L21	77	170
	44,6	195	1,8	IRAS0E31	67	148		44,6	270	1,8	IRAS0L31	92	205
	59,6	195	1,8	IRAS0E41	90	198		59,6	270	1,8	IRAS0L41	124	273

COLONNE CON SOPRALZO E ANTA UNICA

Tall units with top unit and single door

IDROBOX

anta singola battente sx senza maniglia (per colonne con due ante)

left single hinged door without handle (for two door tall units)



	L W	H H	SP TH	CODICE CODE	Materico Textured finish	Lacc. opaco Matt lacq.
H 45	29,6	45	1,8	IRAS1411	11	23
	37,1	45	1,8	IRAS1421	13	29
	44,6	45	1,8	IRAS1431	17	35
H 60	29,6	60	1,8	IRAS1511	15	32
	37,1	60	1,8	IRAS1521	18	38
	44,6	60	1,8	IRAS1531	21	47
H 75	29,6	75	1,8	IRAS1611	18	38
	37,1	75	1,8	IRAS1621	22	48
	44,6	75	1,8	IRAS1631	26	58
H 180	29,6	180	1,8	IRAS1D11	42	91
	37,1	180	1,8	IRAS1D21	51	114
	44,6	180	1,8	IRAS1D31	62	137
H 195	29,6	195	1,8	IRAS1E11	46	99
	37,1	195	1,8	IRAS1E21	56	124
	44,6	195	1,8	IRAS1E31	67	148
H 210	29,6	210	1,8	IRAS1F11	48	106
	37,1	210	1,8	IRAS1F21	61	133
	44,6	210	1,8	IRAS1F31	72	159
H 225	29,6	225	1,8	IRAS1G11	51	114
	37,1	225	1,8	IRAS1G21	64	142
	44,6	225	1,8	IRAS1G31	77	171
H 240	29,6	240	1,8	IRAS1H11	54	121
	37,1	240	1,8	IRAS1H21	69	152
	44,6	240	1,8	IRAS1H31	83	182
H 255	29,6	255	1,8	IRAS1I11	58	128
	37,1	255	1,8	IRAS1I21	72	160
	44,6	255	1,8	IRAS1I31	87	194
H 270	29,6	270	1,8	IRAS1L11	62	137
	37,1	270	1,8	IRAS1L21	77	170
	44,6	270	1,8	IRAS1L31	92	205

IDROBOX BASI
IDROBOX BASE UNITS

IDROBOX COLONNE E PENSILI
IDROBOX TALL AND WALL UNITS

IDROBOX ATTREZZATURA
IDROBOX EQUIPMENT

IDROBOX TOP E LAVATOI
IDROBOX TOPS AND WASHBASINS

INGRESSI
HALLWAY CABINETS

SCARPIERE
SHOE CABINETS

ACCESSORI
ACCESSORIES

ELEMENTI SOPRALZO H 45 cm

Top units h 45 cm

IDROBOX

1 anta ribalta

1 lift-up door

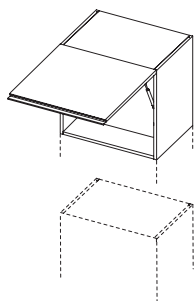

maniglia orizzontale
horizontal handle

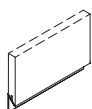

1 anta dx o sx

1 R or L door

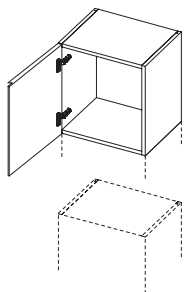

maniglia verticale
vertical handle

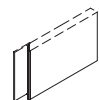

L W	H H	P D	CODICE CODE
--------	--------	--------	----------------

Materico Textured finish	Lacc. opaco Matt lacq.
-----------------------------	---------------------------

P 50	45	45	50	IRS06424	302	333
	60	45	50	IRS06434	327	361
	75	45	50	IRS06444	353	389
	90	45	50	IRS06454	388	428

P 60	45	45	60	IRS06426	314	347
	60	45	60	IRS06436	341	376
	75	45	60	IRS06446	368	405
	90	45	60	IRS06456	404	445

P 70	45	45	70	IRS06427	327	361
	60	45	70	IRS06437	355	391
	75	45	70	IRS06447	382	421
	90	45	70	IRS06457	421	463

L W	H H	P D	CODICE CODE
--------	--------	--------	----------------

Materico Textured finish	Lacc. opaco Matt lacq.
-----------------------------	---------------------------

P 50	30	45	50	IRS08414	243	276
	45	45	50	IRS08424	265	299
	60	45	50	IRS08434	285	320

P 60	30	45	60	IRS08416	254	288
	45	45	60	IRS08426	275	312
	60	45	60	IRS08436	296	334

P 70	30	45	70	IRS08417	265	299
	45	45	70	IRS08427	287	323
	60	45	70	IRS08437	308	347

Nei moduli con ante battenti la posizione della maniglia è sempre verticale.

Fianchi di serie in finitura materico avana. Maggiorazione per fianchi in finitura come il frontale a pagina 17-18.

Maggiorazione per cerniera 180° su ante battenti € 15.

On hinged doors units, the handle position is always vertical.

Standard sides in Avana textured finish. Surcharge for sides in finish like the front on page 17-18. Surcharge for 180° hinge on hinged doors € 15

ELEMENTI SOPRALZO H 45 cm

Top units h 45 cm

IDROBOX

2 ante

2 doors

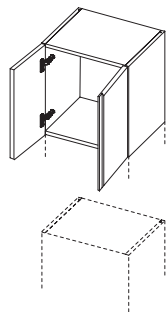

maniglia verticale

vertical handle

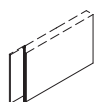

L W	H H	P D	CODICE CODE
--------	--------	--------	----------------

Materico Textured finish	Lacc. opaco Matt lacq.
-----------------------------	---------------------------

	L W	H H	P D	CODICE CODE	Materico Textured finish	Lacc. opaco Matt lacq.
P 50	60	45	50	IRS09434	329	371
	75	45	50	IRS09444	350	403
	90	45	50	IRS09454	373	436
P 60	60	45	60	IRS09436	343	387
	75	45	60	IRS09446	367	421
	90	45	60	IRS09456	388	455
P 70	60	45	70	IRS09437	358	403
	75	45	70	IRS09447	382	438
	90	45	70	IRS09457	404	475

Nei moduli con ante battenti la posizione della maniglia è sempre verticale.
 Fianchi di serie in finitura materico avana. Maggiorazione per fianchi in finitura come il frontale a pagina 17-18.
 Maggiorazione per cerniera 180° su ante battenti € 15.

On hinged doors units, the handle position is always vertical.
 Standard sides in Avana textured finish. Surcharge for sides in finish like the front on page 17-18.
 Surcharge for 180° hinge on hinged doors € 15

IDROBOX BASI
IDROBOX BASE UNITS

IDROBOX COLONNE E PENSILI
IDROBOX TALL AND WALL UNITS

IDROBOX ATTREZZATURA
IDROBOX EQUIPMENT

IDROBOX TOP E LAVATOI
IDROBOX TOPS AND WASHBASINS

INGRESSI
HALLWAY CABINETS

SCARPIERE
SHOE CABINETS

ACCESSORI
ACCESSORIES

ELEMENTI SOPRALZO H 60 cm

Top units h 60 cm

IDROBOX

1 anta ribalta

1 lift-up door

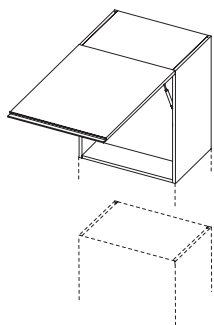

maniglia orizzontale
horizontal handle

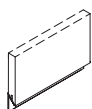

1 anta dx o sx

1 R or L door

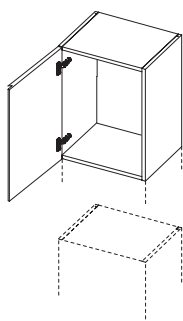

maniglia verticale
vertical handle

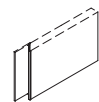

Nei moduli con ante battenti la posizione della maniglia è sempre verticale.

Fianchi di serie in finitura materico avana. Maggiorazione per fianchi in finitura come il frontale a pagina 17-18.

Maggiorazione per cerniera 180° su ante battenti € 15.

L W	H H	P D	CODICE CODE
--------	--------	--------	----------------

Materico Textured finish	Lacc. opaco Matt lacq.
-----------------------------	---------------------------

P 50	45	60	50	IRS06524	330	362
	60	60	50	IRS06534	358	393
	75	60	50	IRS06544	385	422
	90	60	50	IRS06554	426	463

P 60	45	60	60	IRS06526	344	377
	60	60	60	IRS06536	373	409
	75	60	60	IRS06546	401	440
	90	60	60	IRS06556	443	483

P 70	45	60	70	IRS06527	358	393
	60	60	70	IRS06537	387	426
	75	60	70	IRS06547	417	457
	90	60	70	IRS06557	461	502

L W	H H	P D	CODICE CODE
--------	--------	--------	----------------

Materico Textured finish	Lacc. opaco Matt lacq.
-----------------------------	---------------------------

P 50	30	60	50	IRS08514	269	302
	45	60	50	IRS08524	291	327
	60	60	50	IRS08534	314	349

P 60	30	60	60	IRS08516	280	315
	45	60	60	IRS08526	303	341
	60	60	60	IRS08536	327	364

P 70	30	60	70	IRS08517	291	328
	45	60	70	IRS08527	316	354
	60	60	70	IRS08537	340	378

On hinged doors units, the handle position is always vertical.

Standard sides in Avana textured finish. Surcharge for sides in finish like the front on page 17-18. Surcharge for 180° hinge on hinged doors € 15

ELEMENTI SOPRALZO H 60 cm

Top units h 60 cm

IDROBOX

2 ante

2 doors

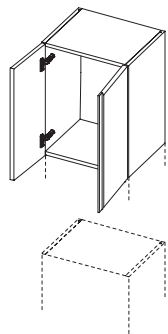

maniglia verticale
vertical handle

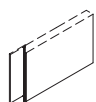

2 ante battenti per colonne con ante rientranti

2 hinged doors for tall units with pocket doors

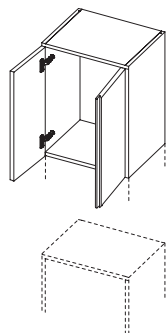

maniglia verticale
vertical handle



Nei moduli con ante battenti la posizione della maniglia è sempre verticale.
Fianchi di serie in finitura materico avana. Maggiorazione per fianchi in finitura come il frontale a pagina 17-18.
Maggiorazione per cerniera 180° su ante battenti € 15.

On hinged doors units, the handle position is always vertical.
Standard sides in Avana textured finish. Surcharge for sides in finish like the front on page 17-18.
Surcharge for 180° hinge on hinged doors € 15

L W	H H	P D	CODICE CODE
--------	--------	--------	----------------

Materico Textured finish	Lacc. opaco Matt lacq.
-----------------------------	---------------------------

	L W	H H	P D	CODICE CODE	Materico Textured finish	Lacc. opaco Matt lacq.
P 50	60	60	50	IRS09534	347	388
	75	60	50	IRS09544	371	422
	90	60	50	IRS09554	393	456
P 60	60	60	60	IRS09536	362	405
	75	60	60	IRS09546	387	441
	90	60	60	IRS09556	411	476
P 70	60	60	70	IRS09537	378	423
	75	60	70	IRS09547	403	461
	90	60	70	IRS09557	429	496

L W	H H	P D	CODICE CODE
--------	--------	--------	----------------

Materico Textured finish	Lacc. opaco Matt lacq.
-----------------------------	---------------------------

P 60	80	60	60	IRS09566	398	447
P 70	80	60	70	IRS09567	416	478

IDROBOX BASI
IDROBOX BASE UNITS

IDROBOX COLONNE E PENSILI
IDROBOX TALL AND WALL UNITS

IDROBOX ATTREZZATURA
IDROBOX EQUIPMENT

IDROBOX TOP E LAVATOI
IDROBOX TOPS AND WASHBASINS

INGRESSI
HALLWAY CABINETS

SCARPIERE
SHOE CABINETS

ACCESSORI
ACCESSORIES

ELEMENTI SOPRALZO ANGOLO H 60 cm

Corner top units h 60 cm

IDROBOX

1 anta dx o sx (scocca vuota)

1 R or L door (empty structure)

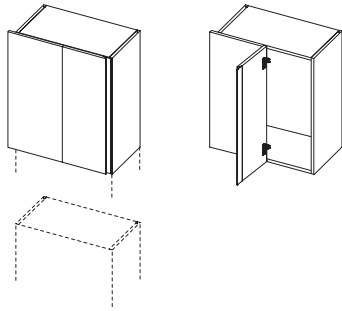

maniglia verticale
vertical handle

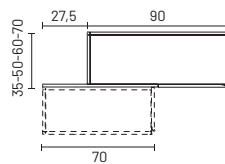
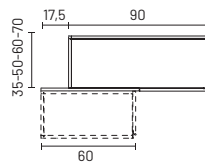
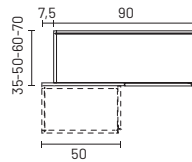
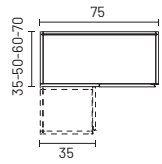
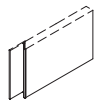

L W	H H	P D	CODICE CODE
--------	--------	--------	----------------

Materico Textured finish	Lacc. opaco Matt lacq.
-----------------------------	---------------------------

	L W	H H	P D	CODICE CODE	Materico Textured finish	Lacc. opaco Matt lacq.
P 35	75	60	35	IRSOH542	347	548
	97,5	60	35	IRSOH552	383	604
	107,5	60	35	IRSOH562	421	664
	117,5	60	35	IRSOH572	463	732
P 50	75	60	50	IRSOH544	372	604
	97,5	60	50	IRSOH554	408	664
	107,5	60	50	IRSOH564	448	732
	117,5	60	50	IRSOH574	493	804
P 60	75	60	60	IRSOH546	397	663
	97,5	60	60	IRSOH556	436	728
	107,5	60	60	IRSOH566	479	802
	117,5	60	60	IRSOH576	528	882
P 70	75	60	70	IRSOH547	420	719
	97,5	60	70	IRSOH557	462	791
	107,5	60	70	IRSOH567	508	871
	117,5	60	70	IRSOH577	561	957

Fianchi di serie in finitura materico avana. Maggiorazione per fianchi in finitura come il frontale a pagina 17-18.

Standard sides in Avana textured finish. Surcharge for sides in finish like the front on page 17-18.

ELEMENTI SOPRALZO H 75 cm

Top units h 75 cm

IDROBOX

1 anta dx o sx

1 R or L door

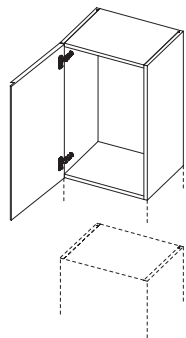

maniglia verticale
vertical handle

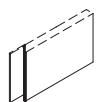

2 ante

2 doors

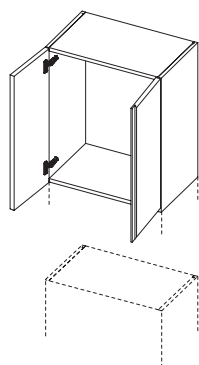

maniglia verticale
vertical handle

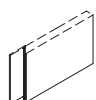

Nei moduli con ante battenti la posizione della maniglia è sempre verticale.
Fianchi di serie in finitura materico avana. Maggiorazione per fianchi come il frontale a pagina 17-18.
Maggiorazione per cerniera 180° su ante battenti € 15.

On hinged doors units, the handle position is always vertical.
Standard sides in Avana textured finish. Surcharge for sides in finish like the front on page 17-18.
Surcharge for 180° hinge on hinged doors € 15

L W	H H	P D	CODICE CODE
--------	--------	--------	----------------

Materico Textured finish	Lacc. opaco Matt lacq.
-----------------------------	---------------------------

P 50

30	75	50	IRS08614
45	75	50	IRS08624
60	75	50	IRS08634

292	328
317	353
341	377

P 60

30	75	60	IRS08616
45	75	60	IRS08626
60	75	60	IRS08636

304	341
330	368
355	393

P 70

30	75	70	IRS08617
45	75	70	IRS08627
60	75	70	IRS08637

317	355
343	382
369	409

L W	H H	P D	CODICE CODE
--------	--------	--------	----------------

Materico Textured finish	Lacc. opaco Matt lacq.
-----------------------------	---------------------------

P 50

60	75	50	IRS09634
75	75	50	IRS09644
90	75	50	IRS09654

377	420
402	455
428	491

P 60

60	75	60	IRS09636
75	75	60	IRS09646
90	75	60	IRS09656

396	438
421	476
447	513

P 70

60	75	70	IRS09637
75	75	70	IRS09647
90	75	70	IRS09657

412	458
440	496
466	535

IDROBOX BASI
IDROBOX BASE UNITS

IDROBOX COLONNE E PENSILI
IDROBOX TALL AND WALL UNITS

IDROBOX ATTREZZATURA
IDROBOX EQUIPMENT

IDROBOX TOP E LAVATOI
IDROBOX TOPS AND WASHBASINS

INGRESSI
HALLWAY CABINETS

SCARPIERE
SHOE CABINETS

ACCESSORI
ACCESSORIES

PANCHE

Benches

IDROBOX

panca sp. 4 cm
bench TH 4 cm

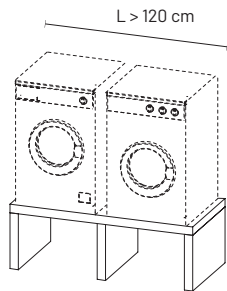
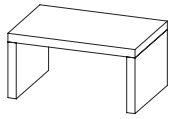

divisorio centrale incluso per L maggiore di 120 cm
central partition included for W greater than 120 cm

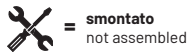

L W	H H	P D	CODICE CODE
--------	--------	--------	----------------

Materico Textured finish	Lacc. opaco Matt lacq.
-----------------------------	---------------------------

P 50						
	L	H	P	Materico	Lacc. opaco	
	60	43,5	50	IRPA04D4	273	620
	75	43,5	50	IRPA04E4	290	670
	90	43,5	50	IRPA04F4	310	722
	105	43,5	50	IRPA04G4	328	767
	120	43,5	50	IRPA04H4	345	823
	135	43,5	50	IRPA04I4	355	860
	150	43,5	50	IRPA04L4	474	1.062
	165	43,5	50	IRPA04M4	491	1.114
	180	43,5	50	IRPA04N4	518	1.190

P 60						
	L	H	P	Materico	Lacc. opaco	
	60	43,5	60	IRPA04D6	289	664
	75	43,5	60	IRPA04E6	309	718
	90	43,5	60	IRPA04F6	328	771
	105	43,5	60	IRPA04G6	346	816
	120	43,5	60	IRPA04H6	367	882
	135	43,5	60	IRPA04I6	377	921
	150	43,5	60	IRPA04L6	506	1.137
	165	43,5	60	IRPA04M6	524	1.194
	180	43,5	60	IRPA04N6	555	1.276

P 70						
	L	H	P	Materico	Lacc. opaco	
	60	43,5	70	IRPA04D7	305	707
	75	43,5	70	IRPA04E7	326	764
	90	43,5	70	IRPA04F7	346	823
	105	43,5	70	IRPA04G7	367	866
	120	43,5	70	IRPA04H7	388	939
	135	43,5	70	IRPA04I7	398	976
	150	43,5	70	IRPA04L7	537	1.214
	165	43,5	70	IRPA04M7	558	1.275
	180	43,5	70	IRPA04N7	592	1.363

Finitura materico sp. 4 cm disponibile solo nelle varianti Bianco, Avana, Quarzo, Sabbia, Noce alabama, Rovere termotrattato, Perla, Argilla.

Th 4 cm textured finish available only in Bianco, Avana, Quarzo, Sabbia, Alabama Walnut, heat-treated Oak, Perla, Argilla.

PANCHE

Benches

IDROBOX

divisorio centrale optional
optional central divider

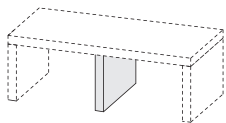

cassettone con ruote (unidirezionali)
deep drawer with wheels (one-way)

apertura tramite maniglia orizzontale
horizontal handle opening

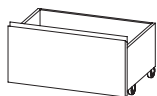

H H	P D	SP TH	CODICE CODE	Materico Textured finish	Lacc. opaco Matt lacq.
--------	--------	----------	----------------	-----------------------------	---------------------------

P 50	39	50	4	IRPAH444	71	151
P 60	39	60	4	IRPAH446	85	169
P 70	39	70	4	IRPAH447	99	195

L W	H H	P D	CODICE CODE	Materico Textured finish	Lacc. opaco Matt lacq.
--------	--------	--------	----------------	-----------------------------	---------------------------

35	38,5	47,5	IRCS0423	229	248
50	38,5	47,5	IRCS0433	265	297
65	38,5	47,5	IRCS0443	299	341
80	38,5	47,5	IRCS0453	346	397
95	38,5	47,5	IRCS0463	394	452

Finitura materico sp. 4 cm disponibile solo nelle varianti Bianco, Avana, Quarzo, Sabbia, Noce alabama, Rovere termotrattato, Perla, Argilla.

Th 4 cm textured finish available only in Bianco, Avana, Quarzo, Sabbia, Alabama Walnut, heat-treated Oak, Perla, Argilla.

IDROBOX BASI
IDROBOX BASE UNITS

IDROBOX COLONNE E PENSILI
IDROBOX TALL AND WALL UNITS

IDROBOX ATTREZZATURA
IDROBOX EQUIPMENT

IDROBOX TOP E LAVATOI
IDROBOX TOPS AND WASHBASINS

INGRESSI
HALLWAY CABINETS

SCARPIERE
SHOE CABINETS

ACCESSORI
ACCESSORIES

ELEMENTI A GIORNO H 156 cm

Open compartments h 156 cm

IDROBOX

elemento portalavatrice sp. 4 cm

washer unit th. 4 cm

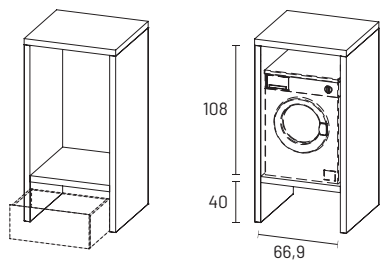

 = smontato
not assembled

L W	H H	P D	CODICE CODE
--------	--------	--------	----------------

Materico Textured finish	Lacc. opaco Matt lacq.
-----------------------------	---------------------------

P 60	75	156	60	IRE01CE6
-------------	-----------	-----	----	----------

652	1.395
------------	--------------

P 70	75	156	70	IRE01CE7
-------------	-----------	-----	----	----------

728	1.563
------------	--------------

elemento portalavatrice + asciugatrice sp. 4 cm

washer + dryer unit th. 4 cm

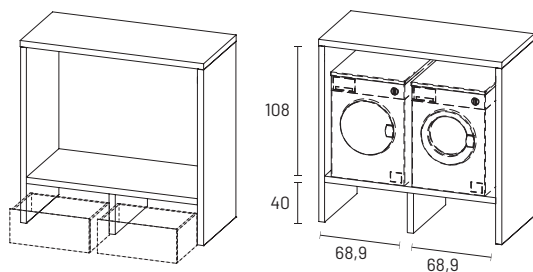

 = smontato
not assembled

L W	H H	P D	CODICE CODE
--------	--------	--------	----------------

Materico Textured finish	Lacc. opaco Matt lacq.
-----------------------------	---------------------------

P 60	150	156	60	IRE01CL6
-------------	------------	-----	----	----------

914	1.713
------------	--------------

P 70	150	156	70	IRE01CL7
-------------	------------	-----	----	----------

1.024	1.919
--------------	--------------

cassettone con ruote (unidirezionali)

deep drawer with wheels (one-way)

apertura tramite maniglia orizzontale

horizontal handle opening

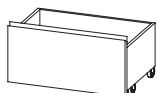

L W	H H	P D	CODICE CODE
--------	--------	--------	----------------

Materico Textured finish	Lacc. opaco Matt lacq.
-----------------------------	---------------------------

65	38,5	47,5	IRCS0443
----	------	------	----------

299	341
------------	------------

Finitura materico disponibile solo nelle varianti Bianco, Avana, Quarzo, Sabbia, Noce alabama, Rovere termotrattato, Perla, Argilla.
Verificare sempre le dimensioni dell'elettrodomestico da inserire e l'ingombro di rubinetti e scarichi.

Textured finish available only in Bianco, Avana, Quarzo, Sabbia, Alabama Walnut, heat-treated Oak, Perla, Argilla.
Always check the size of appliance, taps and drains.

ELEMENTI A GIORNO H 201 cm

Open compartments h 201 cm

IDROBOX

elemento a giorno sp. 4 cm

open compartment unit th. 4 cm

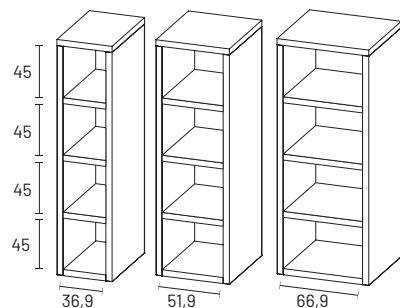

= smontato
not assembled

elemento portalavatrice + asciugatrice impilate sp. 4 cm

stacked washer + dryer unit th. 4 cm

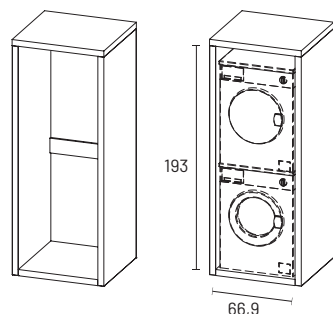

= smontato
not assembled

elemento portalavatrice + asciugatrice sp. 4 cm

washer + dryer unit th. 4 cm

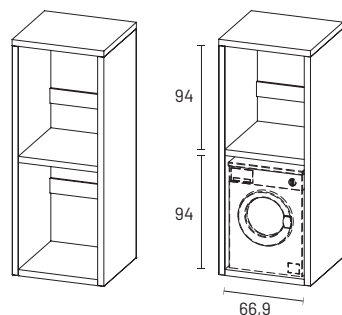

piano estraibile optional (pagina 96)

optional pull-out shelf (page 96)

= smontato
not assembled

L W	H H	P D	CODICE CODE	Materico Textured finish	Lacc. opaco Matt lacq.
--------	--------	--------	----------------	-----------------------------	---------------------------

P 60	45	201	60	IRE02EC6	725	1.466
	60	201	60	IRE02ED6	768	1.543
	75	201	60	IRE02EE6	810	1.613
P 70	45	201	70	IRE02EC7	765	1.642
	60	201	70	IRE02ED7	862	1.728
	75	201	70	IRE02EE7	909	1.806

L W	H H	P D	CODICE CODE	Materico Textured finish	Lacc. opaco Matt lacq.
--------	--------	--------	----------------	-----------------------------	---------------------------

P 60	75	201	60	IRE03EE6	889	2.048
P 70	75	201	70	IRE03EE7	990	2.274

L W	H H	P D	CODICE CODE	Materico Textured finish	Lacc. opaco Matt lacq.
--------	--------	--------	----------------	-----------------------------	---------------------------

P 60	75	201	60	IRE04EE6	927	2.148
P 70	75	201	70	IRE04EE7	1.031	2.383

Finitura materico disponibile solo nelle varianti Bianco, Avana, Quarzo, Sabbia, Noce alabama, Rovere termotrattato, Perla, Argilla.
Verificare sempre le dimensioni dell'elettrodomestico da inserire e l'ingombro di rubinetti e scarichi.

Textured finish available only in Bianco, Avana, Quarzo, Sabbia, Alabama Walnut, heat-treated Oak, Perla, Argilla.
Always check the size of appliance, taps and drains.

IDROBOX BASI
IDROBOX BASE UNITS

IDROBOX COLONNE E PENSILI
IDROBOX TALL AND WALL UNITS

IDROBOX ATTREZZATURA
IDROBOX EQUIPMENT

IDROBOX TOP E LAVATOI
IDROBOX TOPS AND WASHBASINS

INGRESSI
HALLWAY CABINETS

SCARPIERE
SHOE CABINETS

ACCESSORI
ACCESSORIES

ELEMENTI A GIORNO H 201 cm

Open compartments h 201 cm

IDROBOX

elemento portalavatrice + asciugatrice sp. 4 cm (senza fondo)

washer + dryer unit th 4 cm (without bottom)

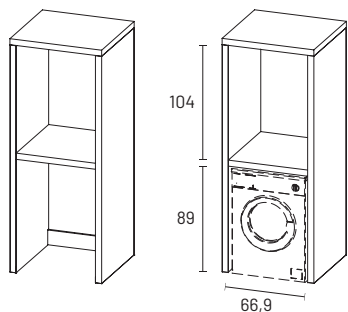

 = smontato
not assembled

L W	H H	P D	CODICE CODE
--------	--------	--------	----------------

Materico Textured finish	Lacc. opaco Matt lacq.
-----------------------------	---------------------------

P 60	75	201	60	IRE05EE6
-------------	-----------	-----	----	----------

889	2.048
------------	--------------

P 70	75	201	70	IRE05EE7
-------------	-----------	-----	----	----------

990	2.274
------------	--------------

elemento portalavatrice sp. 4 cm + 2 vani

washer unit th. 4 cm + 2 open compartments

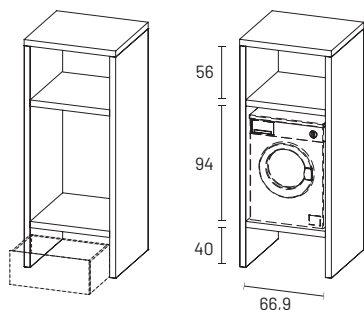

 = smontato
not assembled

L W	H H	P D	CODICE CODE
--------	--------	--------	----------------

Materico Textured finish	Lacc. opaco Matt lacq.
-----------------------------	---------------------------

P 60	75	201	60	IRE06EE6
-------------	-----------	-----	----	----------

883	1.983
------------	--------------

P 70	75	201	70	IRE06EE7
-------------	-----------	-----	----	----------

982	2.206
------------	--------------

elemento portalavatrice sp. 4 cm + 1 vano + ante

washer unit th. 4 cm + 1 open compartment + doors

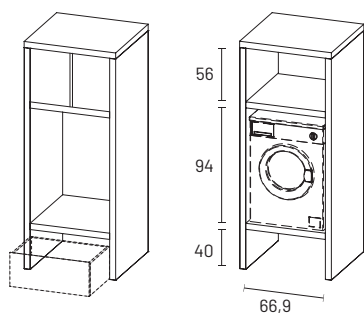

 = smontato
not assembled

L W	H H	P D	CODICE CODE
--------	--------	--------	----------------

Materico Textured finish	Lacc. opaco Matt lacq.
-----------------------------	---------------------------

P 60	75	201	60	IRE07EE6
-------------	-----------	-----	----	----------

971	1.705
------------	--------------

P 70	75	201	70	IRE07EE7
-------------	-----------	-----	----	----------

1.087	1.909
--------------	--------------

Finitura materico disponibile solo nelle varianti Bianco, Avana, Quarzo, Sabbia, Noce alabama, Rovere termotrattato, Perla, Argilla.
Verificare sempre le dimensioni dell'elettrodomestico da inserire e l'ingombro di rubinetti e scarichi.

Textured finish available only in Bianco, Avana, Quarzo, Sabbia, Alabama Walnut, heat-treated Oak, Perla, Argilla.
Always check the size of appliance, taps and drains.

ELEMENTI A GIORNO H 201 cm

Open compartments h 201 cm

IDROBOX

elemento portalavatrice sp. 4 cm + ante

washer unit th. 4 cm + doors

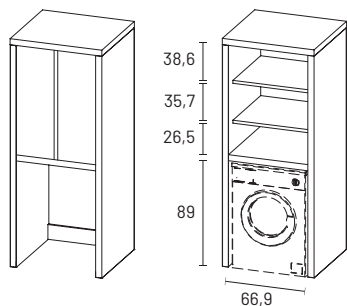

= smontato
not assembled

elemento portalavatrice + asciugatrice sp. 4 cm + 3 vani a giorno

washer + dryer unit th 4 cm + 3 open compartments

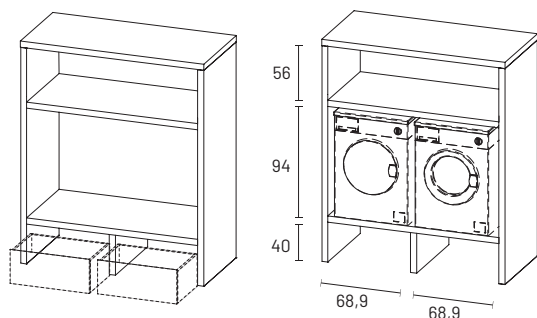

= smontato
not assembled

cassettone con ruote (unidirezionali)

deep drawer with wheels (one-way)

apertura tramite maniglia orizzontale

horizontal handle opening

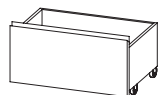

L W	H H	P D	CODICE CODE
--------	--------	--------	----------------

Materico Textured finish	Lacc. opaco Matt lacq.
-----------------------------	---------------------------

P 60	75	201	60	IRE08EE6
------	----	-----	----	----------

1.009	2.311
-------	-------

P 70	75	201	70	IRE08EE7
------	----	-----	----	----------

1.113	2.546
-------	-------

L W	H H	P D	CODICE CODE
--------	--------	--------	----------------

Materico Textured finish	Lacc. opaco Matt lacq.
-----------------------------	---------------------------

P 60	150	201	60	IRE06EL6
------	-----	-----	----	----------

1.195	2.641
-------	-------

P 70	150	201	70	IRE06EL7
------	-----	-----	----	----------

1.300	2.935
-------	-------

L W	H H	P D	CODICE CODE
--------	--------	--------	----------------

Materico Textured finish	Lacc. opaco Matt lacq.
-----------------------------	---------------------------

65	38,5	47,5	IRCS0443
----	------	------	----------

299	341
-----	-----

Finitura materico disponibile solo nelle varianti Bianco, Avana, Quarzo, Sabbia, Noce alabama, Rovere termotrattato, Perla, Argilla.
Verificare sempre le dimensioni dell'elettrodomestico da inserire e l'ingombro di rubinetti e scarichi.

Textured finish available only in Bianco, Avana, Quarzo, Sabbia, Alabama Walnut, heat-treated Oak, Perla, Argilla.
Always check the size of appliance, taps and drains.

IDROBOX BASI
IDROBOX BASE UNITS

IDROBOX COLONNE E PENSILI
IDROBOX TALL AND WALL UNITS

IDROBOX ATTREZZATURA
IDROBOX EQUIPMENT

IDROBOX TOP E LAVATOI
IDROBOX TOPS AND WASHBASINS

INGRESSI
HALLWAY CABINETS

SCARPIERE
SHOE CABINETS

ACCESSORI
ACCESSORIES

ELEMENTI A GIORNO H 216 cm

Open compartments h 216 cm

IDROBOX

elemento a giorno sp. 4 cm

open compartment unit th. 4 cm

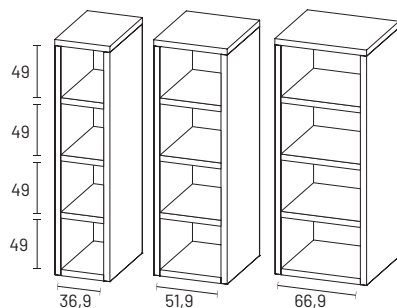

= smontato
not assembled

L W	H H	P D	CODICE CODE
--------	--------	--------	----------------

Materico Textured finish	Lacc. opaco Matt lacq.
-----------------------------	---------------------------

P 60	45	216	60	IRE02FC6	763	1.539
	60	216	60	IRE02FD6	807	1.622
	75	216	60	IRE02FE6	852	1.695
P 70	45	216	70	IRE02FC7	804	1.725
	60	216	70	IRE02FD7	904	1.816
	75	216	70	IRE02FE7	954	1.898

elemento portalavatrice + asciugatrice impilate sp. 4 cm

stacked washer + dryer unit th. 4 cm

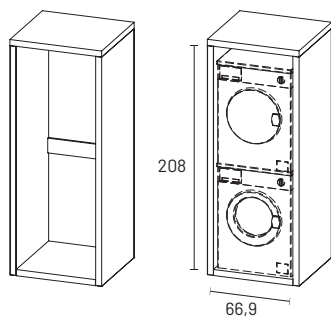

= smontato
not assembled

L W	H H	P D	CODICE CODE
--------	--------	--------	----------------

Materico Textured finish	Lacc. opaco Matt lacq.
-----------------------------	---------------------------

P 60	75	216	60	IRE03FE6	936	2.151
	75	216	70	IRE03FE7	1.041	2.388

elemento portalavatrice + asciugatrice sp. 4 cm

washer + dryer unit th. 4 cm

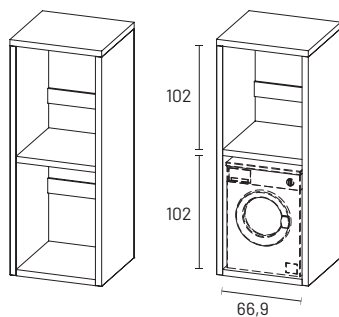

piano estraibile optional (pagina 96)
optional pull-out shelf (page 96)

= smontato
not assembled

L W	H H	P D	CODICE CODE
--------	--------	--------	----------------

Materico Textured finish	Lacc. opaco Matt lacq.
-----------------------------	---------------------------

P 60	75	216	60	IRE04FE6	974	2.254
	75	216	70	IRE04FE7	1.084	2.503

Finitura materico disponibile solo nelle varianti Bianco, Avana, Quarzo, Sabbia, Noce alabama, Rovere termotrattato, Perla, Argilla.
Verificare sempre le dimensioni dell'elettrodomestico da inserire e l'ingombro di rubinetti e scarichi.

Textured finish available only in Bianco, Avana, Quarzo, Sabbia, Alabama Walnut, heat-treated Oak, Perla, Argilla.
Always check the size of appliance, taps and drains.

ELEMENTI A GIORNO H 216 cm

Open compartments h 216 cm

IDROBOX

elemento portalavatrice + asciugatrice sp. 4 cm (senza fondo)

washer + dryer unit th 4 cm (without bottom)

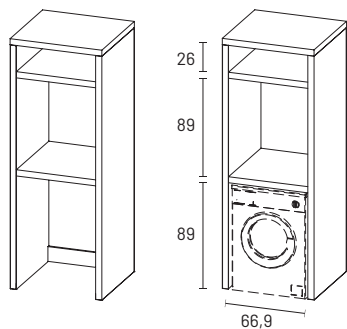

= smontato
not assembled

elemento portalavatrice sp. 4 cm + 3 vani

washer unit th. 4 cm + 3 open compartments

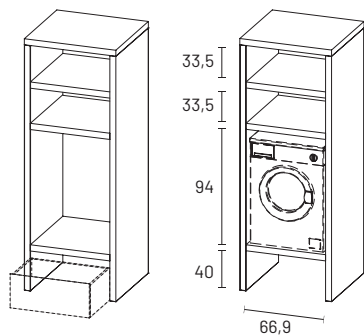

= smontato
not assembled

elemento portalavatrice sp. 4 cm + 1 vano + ante

washer unit th. 4 cm + 1 open compartment + doors

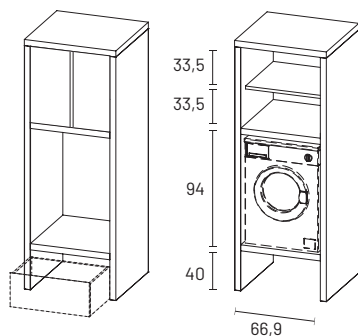

= smontato
not assembled

L W	H H	P D	CODICE CODE
--------	--------	--------	----------------

Materico Textured finish	Lacc. opaco Matt lacq.
-----------------------------	---------------------------

P 60	75	216	60	IRE05FE6
------	----	-----	----	----------

936	2.151
-----	-------

P 70	75	216	70	IRE05FE7
------	----	-----	----	----------

1.041	2.388
-------	-------

L W	H H	P D	CODICE CODE
--------	--------	--------	----------------

Materico Textured finish	Lacc. opaco Matt lacq.
-----------------------------	---------------------------

P 60	75	216	60	IRE09FE6
------	----	-----	----	----------

927	2.083
-----	-------

P 70	75	216	70	IRE09FE7
------	----	-----	----	----------

1.032	2.316
-------	-------

L W	H H	P D	CODICE CODE
--------	--------	--------	----------------

Materico Textured finish	Lacc. opaco Matt lacq.
-----------------------------	---------------------------

P 60	75	216	60	IRE07FE6
------	----	-----	----	----------

1.020	1.791
-------	-------

P 70	75	216	70	IRE07FE7
------	----	-----	----	----------

1.142	2.005
-------	-------

Finitura materico disponibile solo nelle varianti Bianco, Avana, Quarzo, Sabbia, Noce alabama, Rovere termotrattato, Perla, Argilla.
Verificare sempre le dimensioni dell'elettrodomestico da inserire e l'ingombro di rubinetti e scarichi.

Textured finish available only in Bianco, Avana, Quarzo, Sabbia, Alabama Walnut, heat-treated Oak, Perla, Argilla.
Always check the size of appliance, taps and drains.

IDROBOX BASI
IDROBOX BASE UNITS

IDROBOX COLONNE E PENSILI
IDROBOX TALL AND WALL UNITS

IDROBOX ATTREZZATURA
IDROBOX EQUIPMENT

IDROBOX TOP E LAVATOI
IDROBOX TOPS AND WASHBASINS

INGRESSI
HALLWAY CABINETS

SCARPIERE
SHOE CABINETS

ACCESSORI
ACCESSORIES

ELEMENTI A GIORNO H 216 cm

Open compartments h 216 cm

IDROBOX

elemento portalavatrice sp. 4 cm + ante

washer unit th. 4 cm + doors

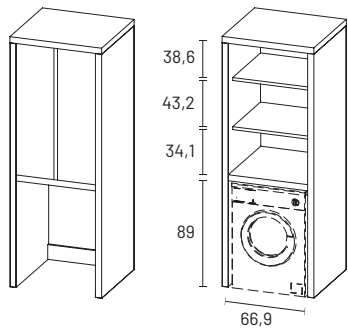

 = smontato
not assembled

L W	H H	P D	CODICE CODE
--------	--------	--------	----------------

Materico Textured finish	Lacc. opaco Matt lacq.
-----------------------------	---------------------------

P 60	75	216	60	IRE08FE6
-------------	-----------	-----	----	----------

1.060	2.426
--------------	--------------

P 70	75	216	70	IRE08FE7
-------------	-----------	-----	----	----------

1.169	2.675
--------------	--------------

elemento portalavatrice + asciugatrice sp. 4 cm + 4 vani a giorno

washer + dryer unit th 4 cm + 4 open compartments

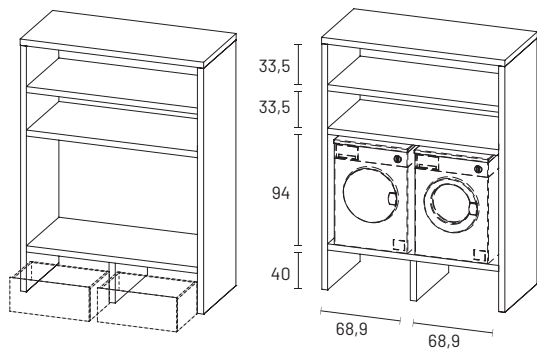

 = smontato
not assembled

L W	H H	P D	CODICE CODE
--------	--------	--------	----------------

Materico Textured finish	Lacc. opaco Matt lacq.
-----------------------------	---------------------------

P 60	150	216	60	IRE09FL6
-------------	------------	-----	----	----------

1.257	2.774
--------------	--------------

P 70	150	216	70	IRE09FL7
-------------	------------	-----	----	----------

1.365	3.082
--------------	--------------

cassettone con ruote (unidirezionali)

deep drawer with wheels (one-way)

apertura tramite maniglia orizzontale
horizontal handle opening

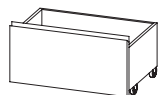

L W	H H	P D	CODICE CODE
--------	--------	--------	----------------

Materico Textured finish	Lacc. opaco Matt lacq.
-----------------------------	---------------------------

65	38,5	47,5	IRCS0443
----	------	------	----------

299	341
------------	------------

Finitura materico disponibile solo nelle varianti Bianco, Avana, Quarzo, Sabbia, Noce alabama, Rovere termotrattato, Perla, Argilla.
Verificare sempre le dimensioni dell'elettrodomestico da inserire e l'ingombro di rubinetti e scarichi.

Textured finish available only in Bianco, Avana, Quarzo, Sabbia, Alabama Walnut, heat-treated Oak, Perla, Argilla.
Always check the size of appliance, taps and drains.

PENSILI H 45 cm

Wall units h 45 cm

IDROBOX

1 anta ribalta

1 lift-up door

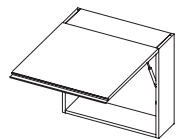

maniglia orizzontale
horizontal handle

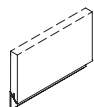

1 anta dx o sx

1 R or L door

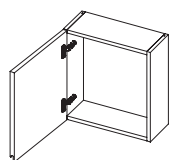

maniglia orizzontale o verticale
horizontal or vertical handle

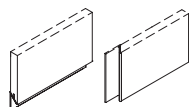

L W	H H	P D	CODICE CODE
--------	--------	--------	----------------

Materico Textured finish	Lacc. opaco Matt lacq.
-----------------------------	---------------------------

P 20	45	45	20	IRPS6421	243	267
	60	45	20	IRPS6431	263	289
	75	45	20	IRPS6441	285	312
	90	45	20	IRPS6451	315	342

P 35	45	45	35	IRPS6422	289	319
	60	45	35	IRPS6432	314	346
	75	45	35	IRPS6442	337	373
	90	45	35	IRPS6452	373	411

P 50	45	45	50	IRPS6424	302	333
	60	45	50	IRPS6434	327	361
	75	45	50	IRPS6444	353	389
	90	45	50	IRPS6454	388	428

P 60	45	45	60	IRPS6426	314	347
	60	45	60	IRPS6436	341	376
	75	45	60	IRPS6446	368	405
	90	45	60	IRPS6456	404	445

L W	H H	P D	CODICE CODE
--------	--------	--------	----------------

Materico Textured finish	Lacc. opaco Matt lacq.
-----------------------------	---------------------------

P 20	30	45	20	IRPS8411	197	222
	45	45	20	IRPS8421	213	239
	60	45	20	IRPS8431	229	256

P 35	30	45	35	IRPS8412	234	265
	45	45	35	IRPS8422	253	286
	60	45	35	IRPS8432	273	308

P 50	30	45	50	IRPS8414	243	276
	45	45	50	IRPS8424	265	299
	60	45	50	IRPS8434	285	320

P 60	30	45	60	IRPS8416	254	288
	45	45	60	IRPS8426	275	312
	60	45	60	IRPS8436	296	334

Nei moduli con ante battenti specificare la posizione della maniglia: orizzontale o verticale.
Maggiorazione per cerniera 180° su ante battenti € 15.

On hinged doors units, specify the position of the handle: horizontal or vertical.
Surcharge for 180° hinge on hinged doors € 15

IDROBOX BASI
IDROBOX BASE UNITS

IDROBOX COLONNE E PENSILI
IDROBOX TALL AND WALL UNITS

IDROBOX ATTREZZATURA
IDROBOX EQUIPMENT

IDROBOX TOP E LAVATOI
IDROBOX TOPS AND WASHBASINS

INGRESSI
HALLWAY CABINETS

SCARPIERE
SHOE CABINETS

ACCESSORI
ACCESSORIES

PENSILI H 45 cm

Wall units h 45 cm

IDROBOX

2 ante

2 doors

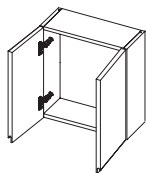

maniglia orizzontale o verticale
horizontal or vertical handle

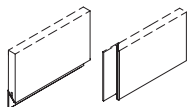

L W	H H	P D	CODICE CODE
--------	--------	--------	----------------

Materico Textured finish	Lacc. opaco Matt lacq.
-----------------------------	---------------------------

	L W	H H	P D	CODICE CODE	Materico Textured finish	Lacc. opaco Matt lacq.
P 20	60	45	20	IRPS9431	255	285
	75	45	20	IRPS9441	272	309
	90	45	20	IRPS9451	288	333
P 35	60	45	35	IRPS9432	301	340
	75	45	35	IRPS9442	320	369
	90	45	35	IRPS9452	341	399
P 50	60	45	50	IRPS9434	315	355
	75	45	50	IRPS9444	335	386
	90	45	50	IRPS9454	357	417
P 60	60	45	60	IRPS9436	329	371
	75	45	60	IRPS9446	350	403
	90	45	60	IRPS9456	373	436

Nei moduli con ante battenti specificare la posizione della maniglia: orizzontale o verticale.
Maggiorazione per cerniera 180° su ante battenti € 15.

On hinged doors units, specify the position of the handle: horizontal or vertical.
Surcharge for 180° hinge on hinged doors € 15

PENSILI H 60 cm

Wall units h 60 cm

IDROBOX

1 anta ribalta

1 lift-up door

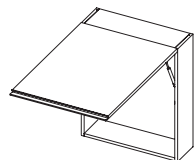

maniglia orizzontale
horizontal handle

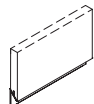

1 anta dx o sx

1 R or L door

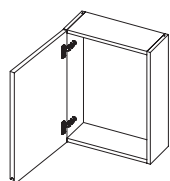

maniglia orizzontale o verticale
horizontal or vertical handle

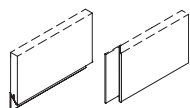

L W	H H	P D	CODICE CODE
--------	--------	--------	----------------

Materico Textured finish	Lacc. opaco Matt lacq.
-----------------------------	---------------------------

P 20	45	60	20	IRPS6521	266	290
	60	60	20	IRPS6531	289	314
	75	60	20	IRPS6541	312	335
	90	60	20	IRPS6551	344	369

P 35	45	60	35	IRPS6522	316	348
	60	60	35	IRPS6532	343	376
	75	60	35	IRPS6542	370	404
	90	60	35	IRPS6552	408	444

P 50	45	60	50	IRPS6524	330	362
	60	60	50	IRPS6534	358	393
	75	60	50	IRPS6544	385	422
	90	60	50	IRPS6554	426	463

P 60	45	60	60	IRPS6526	344	377
	60	60	60	IRPS6536	373	409
	75	60	60	IRPS6546	401	440
	90	60	60	IRPS6556	443	483

L W	H H	P D	CODICE CODE
--------	--------	--------	----------------

Materico Textured finish	Lacc. opaco Matt lacq.
-----------------------------	---------------------------

P 20	30	60	20	IRPS8511	218	242
	45	60	20	IRPS8521	236	261
	60	60	20	IRPS8531	253	280

P 35	30	60	35	IRPS8512	258	290
	45	60	35	IRPS8522	279	313
	60	60	35	IRPS8532	301	335

P 50	30	60	50	IRPS8514	269	302
	45	60	50	IRPS8524	291	327
	60	60	50	IRPS8534	314	349

P 60	30	60	60	IRPS8516	280	315
	45	60	60	IRPS8526	303	341
	60	60	60	IRPS8536	327	364

Nei moduli con ante battenti specificare la posizione della maniglia: orizzontale o verticale.
Maggiorazione per cerniera 180° su ante battenti € 15.

On hinged doors units, specify the position of the handle: horizontal or vertical.
Surcharge for 180° hinge on hinged doors € 15

IDROBOX BASI
IDROBOX BASE UNITS

IDROBOX COLONNE E PENSILI
IDROBOX TALL AND WALL UNITS

IDROBOX ATTREZZATURA
IDROBOX EQUIPMENT

IDROBOX TOP E LAVATOI
IDROBOX TOPS AND WASHBASINS

INGRESSI
HALLWAY CABINETS

SCARPIERE
SHOE CABINETS

ACCESSORI
ACCESSORIES

PENSILI H 60 cm

Wall units h 60 cm

IDROBOX

2 ante

2 doors

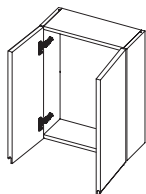

maniglia orizzontale o verticale
horizontal or vertical handle

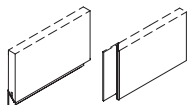

L W	H H	P D	CODICE CODE
--------	--------	--------	----------------

Materico Textured finish	Lacc. opaco Matt lacq.
-----------------------------	---------------------------

	L W	H H	P D	CODICE CODE	Materico Textured finish	Lacc. opaco Matt lacq.
P 20	60	60	20	IRPS9531	281	312
	75	60	20	IRPS9541	300	337
	90	60	20	IRPS9551	318	362
P 35	60	60	35	IRPS9532	331	371
	75	60	35	IRPS9542	354	402
	90	60	35	IRPS9552	375	435
P 50	60	60	50	IRPS9534	347	388
	75	60	50	IRPS9544	371	422
	90	60	50	IRPS9554	393	456
P 60	60	60	60	IRPS9536	362	405
	75	60	60	IRPS9546	387	441
	90	60	60	IRPS9556	411	476

Nei moduli con ante battenti specificare la posizione della maniglia: orizzontale o verticale.
Maggiorazione per cerniera 180° su ante battenti € 15.

On hinged doors units, specify the position of the handle: horizontal or vertical.
Surcharge for 180° hinge on hinged doors € 15

PENSILI SPECCHIO H 60 cm

Mirror wall units h 60 cm

IDROBOX

1 anta ribalta specchio

1 mirror lift-up door

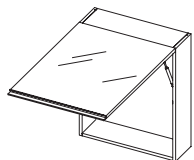

maniglia orizzontale
horizontal handle

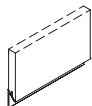

1 anta specchio dx o sx

1 mirror R or L door

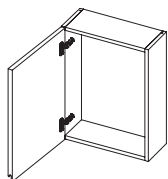

maniglia orizzontale
horizontal handle

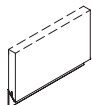

2 ante specchio

2 mirror doors

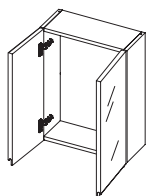

maniglia orizzontale
horizontal handle

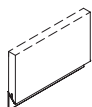

Maniglia posizionata sempre in orizzontale.

Handle always positioned horizontally.

L W	H H	P D	CODICE CODE
--------	--------	--------	----------------

Materico Textured finish	Lacc. opaco Matt lacq.
-----------------------------	---------------------------

P 20

45	60	20	IRPT7521
60	60	20	IRPT7531
75	60	20	IRPT7541
90	60	20	IRPT7551

347	377
376	408
405	438
448	480

L W	H H	P D	CODICE CODE
--------	--------	--------	----------------

Materico Textured finish	Lacc. opaco Matt lacq.
-----------------------------	---------------------------

P 20

30	60	20	IRPT8511
45	60	20	IRPT8521
60	60	20	IRPT8531

283	316
306	341
330	363

L W	H H	P D	CODICE CODE
--------	--------	--------	----------------

Materico Textured finish	Lacc. opaco Matt lacq.
-----------------------------	---------------------------

P 20

60	60	20	IRPT9531
75	60	20	IRPT9541
90	60	20	IRPT9551

401	444
428	481
454	518

IDROBOX BASI
IDROBOX BASE UNITS

IDROBOX COLONNE E PENSILI
IDROBOX TALL AND WALL UNITS

IDROBOX ATTREZZATURA
IDROBOX EQUIPMENT

IDROBOX TOP E LAVATOI
IDROBOX TOPS AND WASHBASINS

INGRESSI
HALLWAY CABINETS

SCARPIERE
SHOE CABINETS

ACCESSORI
ACCESSORIES

PENSILI H 75 cm

Wall units h 75 cm

IDROBOX

1 ante dx o sx

1 R or L door

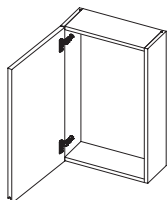

maniglia orizzontale o verticale
horizontal or vertical handle

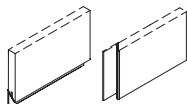

L W	H H	P D	CODICE CODE
--------	--------	--------	----------------

Materico Textured finish	Lacc. opaco Matt lacq.
-----------------------------	---------------------------

P 20	30	75	20	IRPS8611
	45	75	20	IRPS8621
	60	75	20	IRPS8631

237	262
256	281
275	301

P 35	30	75	35	IRPS8612
	45	75	35	IRPS8622
	60	75	35	IRPS8632

281	314
303	339
327	361

2 ante

2 doors

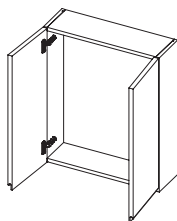

maniglia orizzontale o verticale
horizontal or vertical handle

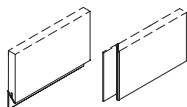

L W	H H	P D	CODICE CODE
--------	--------	--------	----------------

Materico Textured finish	Lacc. opaco Matt lacq.
-----------------------------	---------------------------

P 20	60	75	20	IRPS9631
	75	75	20	IRPS9641
	90	75	20	IRPS9651

320	353
342	380
362	409

P 35	60	75	35	IRPS9632
	75	75	35	IRPS9642
	90	75	35	IRPS9652

377	420
402	455
428	491

Nei moduli con ante battenti specificare la posizione della maniglia: orizzontale o verticale.
Maggiorazione per cerniera 180° su ante battenti € 15.

On hinged doors units, specify the position of the handle: horizontal or vertical.
Surcharge for 180° hinge on hinged doors € 15

PENSILI H 90 cm

Wall units h 90 cm

IDROBOX

1 anta dx o sx

1 R or L door

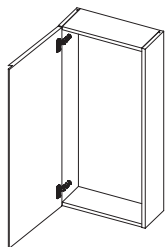

maniglia verticale
vertical handle

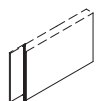

2 ante

2 doors

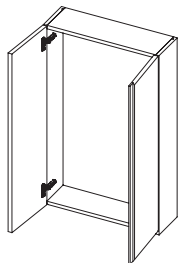

maniglia verticale
vertical handle



L W	H H	P D	CODICE CODE
--------	--------	--------	----------------

Materico Textured finish	Lacc. opaco Matt lacq.
-----------------------------	---------------------------

P 20

30	90	20	IRPS8811
45	90	20	IRPS8821
60	90	20	IRPS8831

247	273
267	291
287	312

P 35

30	90	35	IRPS8812
45	90	35	IRPS8822
60	90	35	IRPS8832

292	326
317	349
341	374

L W	H H	P D	CODICE CODE
--------	--------	--------	----------------

Materico Textured finish	Lacc. opaco Matt lacq.
-----------------------------	---------------------------

P 20

60	90	20	IRPS9831
75	90	20	IRPS9841
90	90	20	IRPS9851

335	364
357	394
378	423

P 35

60	90	35	IRPS9832
75	90	35	IRPS9842
90	90	35	IRPS9852

394	435
421	471
447	508

Maniglia posizionata sempre in verticale.
Maggiorazione per cerniera 180° su ante battenti € 15.

Handle always positioned vertically.
Surcharge for 180° hinge on hinged doors € 15

IDROBOX BASI
IDROBOX BASE UNITS

IDROBOX COLONNE E PENSILI
IDROBOX TALL AND WALL UNITS

IDROBOX ATTREZZATURA
IDROBOX EQUIPMENT

IDROBOX TOP E LAVATOI
IDROBOX TOPS AND WASHBASINS

INGRESSI
HALLWAY CABINETS

SCARPIERE
SHOE CABINETS

ACCESSORI
ACCESSORIES

PENSILI H 105 cm

Wall units h 105 cm

IDROBOX

1 ante dx o sx

1 R or L door

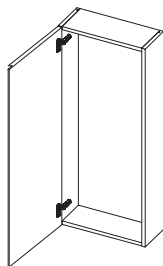

maniglia verticale
vertical handle



L W	H H	P D	CODICE CODE
--------	--------	--------	----------------

Materico Textured finish	Lacc. opaco Matt lacq.
-----------------------------	---------------------------

P 20	30	105	20	IRPS8911
	45	105	20	IRPS8921
	60	105	20	IRPS8931

266	306
287	328
308	347

P 35	30	105	35	IRPS8912
	45	105	35	IRPS8922
	60	105	35	IRPS8932

314	367
340	393
364	418

2 ante

2 doors

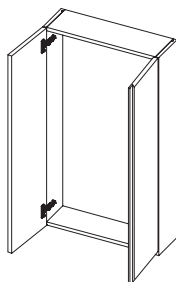

maniglia verticale
vertical handle



L W	H H	P D	CODICE CODE
--------	--------	--------	----------------

Materico Textured finish	Lacc. opaco Matt lacq.
-----------------------------	---------------------------

P 20	60	105	20	IRPS9931
	75	105	20	IRPS9941
	90	105	20	IRPS9951

361	411
385	442
407	475

P 35	60	105	35	IRPS9932
	75	105	35	IRPS9942
	90	105	35	IRPS9952

425	490
451	530
479	569

Maniglia posizionata sempre in verticale.
Maggiorazione per cerniera 180° su ante battenti € 15.

Handle always positioned vertically.
Surcharge for 180° hinge on hinged doors € 15

PENSILI H 120 cm

Wall units h 120 cm

IDROBOX

1 anta dx o sx

1 R or L door

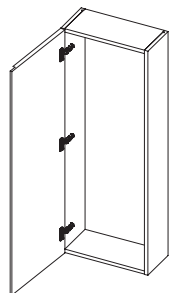

maniglia verticale
vertical handle

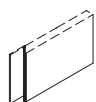

2 ante

2 doors

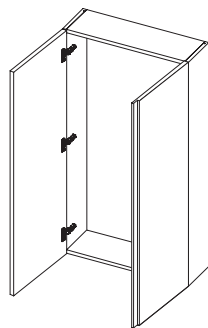

maniglia verticale
vertical handle

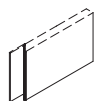

L W	H H	P D	CODICE CODE
--------	--------	--------	----------------

Materico Textured finish	Lacc. opaco Matt lacq.
-----------------------------	---------------------------

P 20

30	120	20	IRPS8A11
45	120	20	IRPS8A21
60	120	20	IRPS8A31

272	326
309	373
346	422

P 35

30	120	35	IRPS8A12
45	120	35	IRPS8A22
60	120	35	IRPS8A32

320	398
364	461
409	522

L W	H H	P D	CODICE CODE
--------	--------	--------	----------------

Materico Textured finish	Lacc. opaco Matt lacq.
-----------------------------	---------------------------

P 20

60	120	20	IRPS9A31
75	120	20	IRPS9A41
90	120	20	IRPS9A51

376	451
420	510
463	571

P 35

60	120	35	IRPS9A32
75	120	35	IRPS9A42
90	120	35	IRPS9A52

437	544
489	617
538	691

Maniglia posizionata sempre in verticale.
Maggiorazione per cerniera 180° su ante battenti € 15.

Handle always positioned vertically.
Surcharge for 180° hinge on hinged doors € 15

IDROBOX BASI
IDROBOX BASE UNITS

IDROBOX COLONNE E PENSILI
IDROBOX TALL AND WALL UNITS

IDROBOX ATTREZZATURA
IDROBOX EQUIPMENT

IDROBOX TOP E LAVATOI
IDROBOX TOPS AND WASHBASINS

INGRESSI
HALLWAY CABINETS

SCARPIERE
SHOE CABINETS

ACCESSORI
ACCESSORIES

PENSILI H 120 cm

Wall units h 120 cm

IDROBOX

1 anta dx o sx copriboiler

boiler cover 1 R or L door

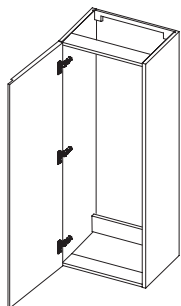

maniglia verticale

vertical handle

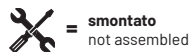
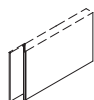

L W	H H	P D	CODICE CODE
--------	--------	--------	----------------

Materico Textured finish	Lacc. opaco Matt lacq.
-----------------------------	---------------------------

P 60	60	120	60	IRPSBA36
------	----	-----	----	----------

437	451
-----	-----

Maniglia posizionata sempre in verticale.

Handle always positioned vertically.

PENSILI H 135 cm

Wall units h 135 cm

IDROBOX

1 anta dx o sx

1 R or L door

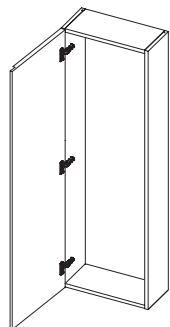

maniglia verticale

vertical handle

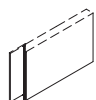

2 ante

2 doors

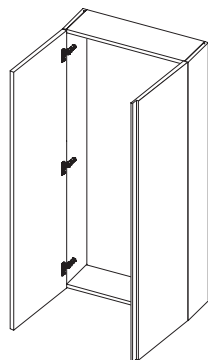

maniglia verticale

vertical handle

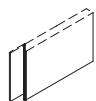

Maniglia posizionata sempre in verticale.
Maggiorazione per cerniera 180° su ante battenti € 15.

Handle always positioned vertically.
Surcharge for 180° hinge on hinged doors € 15

L W	H H	P D	CODICE CODE
--------	--------	--------	----------------

Materico Textured finish	Lacc. opaco Matt lacq.
-----------------------------	---------------------------

P 20

30	135	20	IRPS8B11
45	135	20	IRPS8B21
60	135	20	IRPS8B31

290	348
329	401
369	452

P 35

30	135	35	IRPS8B12
45	135	35	IRPS8B22
60	135	35	IRPS8B32

342	427
389	493
437	560

L W	H H	P D	CODICE CODE
--------	--------	--------	----------------

Materico Textured finish	Lacc. opaco Matt lacq.
-----------------------------	---------------------------

P 20

60	135	20	IRPS9B31
75	135	20	IRPS9B41
90	135	20	IRPS9B51

401	481
447	545
492	607

P 35

60	135	35	IRPS9B32
75	135	35	IRPS9B42
90	135	35	IRPS9B52

465	579
520	658
574	736

IDROBOX BASI
IDROBOX BASE UNITS

IDROBOX COLONNE E PENSILI
IDROBOX TALL AND WALL UNITS

IDROBOX ATTREZZATURA
IDROBOX EQUIPMENT

IDROBOX TOP E LAVATOI
IDROBOX TOPS AND WASHBASINS

INGRESSI
HALLWAY CABINETS

SCARPIERE
SHOE CABINETS

ACCESSORI
ACCESSORIES

PENSILI H 150 cm

Wall units h 150 cm

IDROBOX

1 ante dx o sx

1 R or L door

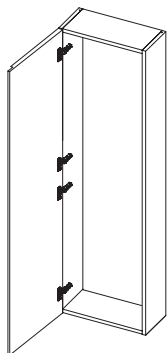

maniglia verticale vertical handle



L W	H H	P D	CODICE CODE
--------	--------	--------	----------------

Materico Textured finish	Lacc. opaco Matt lacq.
-----------------------------	---------------------------

P 20

30	150	20	IRPS8C11
45	150	20	IRPS8C21
60	150	20	IRPS8C31

308	372
349	428
391	483

P 35

30	150	35	IRPS8C12
45	150	35	IRPS8C22
60	150	35	IRPS8C32

362	456
413	528
464	598

2 ante

2 doors

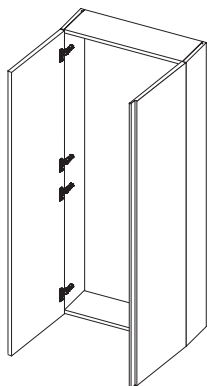

maniglia verticale vertical handle



L W	H H	P D	CODICE CODE
--------	--------	--------	----------------

Materico Textured finish	Lacc. opaco Matt lacq.
-----------------------------	---------------------------

P 20

60	150	20	IRPS9C31
75	150	20	IRPS9C41
90	150	20	IRPS9C51

404	486
451	550
496	613

P 35

60	150	35	IRPS9C32
75	150	35	IRPS9C42
90	150	35	IRPS9C52

470	587
524	666
579	744

Maniglia posizionata sempre in verticale.
Maggiorazione per cerniera 180° su ante battenti € 15.

Handle always positioned vertically.
Surcharge for 180° hinge on hinged doors € 15

PENSILI H 180 cm

Wall units h 180 cm

IDROBOX

1 anta dx o sx

1 R or L door

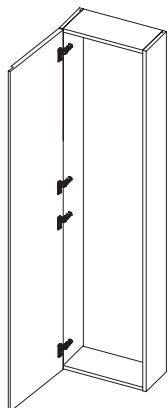

maniglia verticale

vertical handle

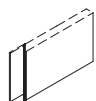

2 ante

2 doors

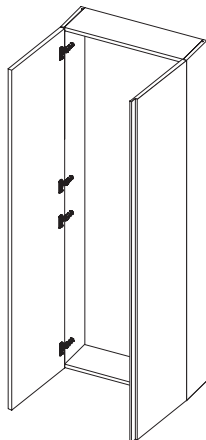

maniglia verticale

vertical handle

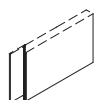

Maniglia posizionata sempre in verticale.
Maggiorazione per cerniera 180° su ante battenti € 15.

Handle always positioned vertically.
Surcharge for 180° hinge on hinged doors € 15

L W	H H	P D	CODICE CODE
--------	--------	--------	----------------

Materico Textured finish	Lacc. opaco Matt lacq.
-----------------------------	---------------------------

P 20

30	180	20	IRPS8D11
45	180	20	IRPS8D21
60	180	20	IRPS8D31

335	402
382	461
427	520

P 35

30	180	35	IRPS8D12
45	180	35	IRPS8D22
60	180	35	IRPS8D32

396	493
450	569
490	573

L W	H H	P D	CODICE CODE
--------	--------	--------	----------------

Materico Textured finish	Lacc. opaco Matt lacq.
-----------------------------	---------------------------

P 20

60	180	20	IRPS9D31
75	180	20	IRPS9D41
90	180	20	IRPS9D51

464	548
518	619
572	691

P 35

60	180	35	IRPS9D32
75	180	35	IRPS9D42
90	180	35	IRPS9D52

538	661
602	750
660	839

IDROBOX BASI
IDROBOX BASE UNITS

IDROBOX COLONNE E PENSILI
IDROBOX TALL AND WALL UNITS

IDROBOX ATTREZZATURA
IDROBOX EQUIPMENT

IDROBOX TOP E LAVATOI
IDROBOX TOPS AND WASHBASINS

INGRESSI
HALLWAY CABINETS

SCARPIERE
SHOE CABINETS

ACCESSORI
ACCESSORIES

PENSILI H 195 cm

Wall units h 195 cm

IDROBOX

1 ante dx o sx

1 R or L door

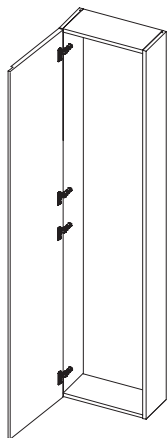

maniglia verticale
vertical handle

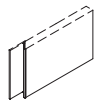

L W	H H	P D	CODICE CODE
--------	--------	--------	----------------

Materico Textured finish	Lacc. opaco Matt lacq.
-----------------------------	---------------------------

P 20	30	195	20	IRPS8E11	346	411
	45	195	20	IRPS8E21	393	470
	60	195	20	IRPS8E31	440	530
P 35	30	195	35	IRPS8E12	408	504
	45	195	35	IRPS8E22	464	579
	60	195	35	IRPS8E32	546	636

2 ante

2 doors

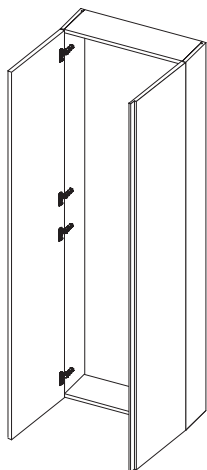

maniglia verticale
vertical handle

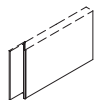

L W	H H	P D	CODICE CODE
--------	--------	--------	----------------

Materico Textured finish	Lacc. opaco Matt lacq.
-----------------------------	---------------------------

P 20	60	195	20	IRPS9E31	483	561
	75	195	20	IRPS9E41	536	632
	90	195	20	IRPS9E51	590	704
P 35	60	195	35	IRPS9E32	560	677
	75	195	35	IRPS9E42	624	765
	90	195	35	IRPS9E52	688	854

Maniglia posizionata sempre in verticale.
Maggiorazione per cerniera 180° su ante battenti € 15.

Handle always positioned vertically.
Surcharge for 180° hinge on hinged doors € 15

ATTREZZATURA INTERNA INTERNAL EQUIPMENT	P. 94
SPALLE DI FINITURA FINISHING PANELS	P. 102
BASAMENTI BASES	P. 103
ILLUMINAZIONE LIGHTING	P. 104
BAMBOO	P. 106

ripiano sp. 1,8 cm

1,8 cm th. shelf



L W	SP TH	P D	CODICE CODE	Prezzo Price
--------	----------	--------	----------------	-----------------

P 20	30	1,8	20	IRRX0011	20
	45	1,8	20	IRRX0021	21
	60	1,8	20	IRRX0031	22
	75	1,8	20	IRRX0041	25
	90	1,8	20	IRRX0051	26

P 35	30	1,8	35	IRRX0012	21
	45	1,8	35	IRRX0022	22
	60	1,8	35	IRRX0032	25
	75	1,8	35	IRRX0042	26
	90	1,8	35	IRRX0052	27

P 50	30	1,8	50	IRRX0014	22
	45	1,8	50	IRRX0024	25
	60	1,8	50	IRRX0034	27
	75	1,8	50	IRRX0044	29
	90	1,8	50	IRRX0054	30

P 60	30	1,8	60	IRRX0015	25
	45	1,8	60	IRRX0025	27
	60	1,8	60	IRRX0035	30
	75	1,8	60	IRRX0045	35
	90	1,8	60	IRRX0055	42

P 70	30	1,8	70	IRRX0016	27
	45	1,8	70	IRRX0026	30
	60	1,8	70	IRRX0036	33
	75	1,8	70	IRRX0046	37
	90	1,8	70	IRRX0056	43

ATTREZZATURA INTERNA

Internal equipment

IDROBOX

ripiano sp. 1,8 cm per basi angolo

1,8 cm th shelf for corner base units



L W	SP TH	P D	CODICE CODE	Prezzo Price
--------	----------	--------	----------------	-----------------

P 82	82	1,8	82	IRRA0044	72
-------------	-----------	-----	----	----------	-----------

P 92	92	1,8	92	IRRA0055	87
-------------	-----------	-----	----	----------	-----------

P 102	102	1,8	102	IRRA0066	104
--------------	------------	-----	-----	----------	------------

ripiano sp. 1,8 cm per modulo terminale/di raccordo

1,8 cm shelf for end/connection unit



L W	SP TH	P D	CODICE CODE	Prezzo Price
--------	----------	--------	----------------	-----------------

P 60 dx rh	40	1,8	60	IRRT0045D	57
---------------------	-----------	-----	----	-----------	-----------

sx lh	40	1,8	60	IRRT0045S	57
----------------	-----------	-----	----	-----------	-----------

ripiano sp. 1,8 cm per basi/elementi sopra/alzo/colonne per angolo sfruttabile

1,8 cm th shelf for bases/top units/tall units for corner space



L W	SP TH	P D	CODICE CODE	Prezzo Price
--------	----------	--------	----------------	-----------------

P 35	75	1,8	35	IRRH0042	26
-------------	-----------	-----	----	----------	-----------

	90	1,8	35	IRRH0052	29
--	-----------	-----	----	----------	-----------

P 50	75	1,8	50	IRRH0044	29
-------------	-----------	-----	----	----------	-----------

	90	1,8	50	IRRH0054	32
--	-----------	-----	----	----------	-----------

P 60	75	1,8	60	IRRH0045	35
-------------	-----------	-----	----	----------	-----------

	90	1,8	60	IRRH0055	44
--	-----------	-----	----	----------	-----------

P 70	75	1,8	70	IRRH0046	39
-------------	-----------	-----	----	----------	-----------

	90	1,8	70	IRRH0056	53
--	-----------	-----	----	----------	-----------

IDROBOX BASI
IDROBOX BASE UNITS

IDROBOX COLONNE E PENSILI
IDROBOX TALL AND WALL UNITS

IDROBOX ATTREZZATURA
IDROBOX EQUIPMENT

IDROBOX TOP E LAVATOI
IDROBOX TOPS AND WASHBASINS

INGRESSI
HALLWAY CABINETS

SCARPIERE
SHOE CABINETS

ACCESSORI
ACCESSORIES

ATTREZZATURA INTERNA

Internal equipment

IDROBOX

ripiano sp. 1,8 cm sagomati per basi lavabo

1,8 cm th shaped shelf for washbasin units

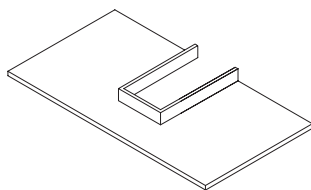

L W	SP TH	P D	CODICE CODE	Prezzo Price
--------	----------	--------	----------------	-----------------

P 50	45	1,8	43	U9RI0024	106
	60	1,8	43	U9RI0034	111
	75	1,8	43	U9RI0044	115
	90	1,8	43	U9RI0054	120

P 60	45	1,8	53	U9RI0025	112
	60	1,8	53	U9RI0035	116
	75	1,8	53	U9RI0045	121
	90	1,8	53	U9RI0055	126

P 70	45	1,8	63	U9RI0026	117
	60	1,8	63	U9RI0036	123
	75	1,8	63	U9RI0046	128
	90	1,8	63	U9RI0056	130

piano estraibile

pull-out shelf

Posizionabile nelle colonne ad altezza max 120 cm da terra. Necessita l'utilizzo di cerniere con apertura a 180°.
Can be positioned in tall units at a maximum height of 120 cm from the ground. Requires 180° hinges.

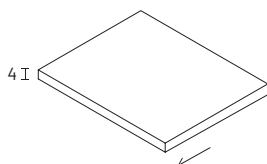

L W	SP TH	P D	CODICE CODE	Prezzo Price
--------	----------	--------	----------------	-----------------

P 50	45	4	50	IRRE0424	172
	60	4	50	IRRE0434	187
	75	4	50	IRRE0444	210

P 60	45	4	60	IRRE0425	180
	60	4	60	IRRE0435	195
	75	4	60	IRRE0445	216

P 70	45	4	70	IRRE0426	186
	60	4	70	IRRE0436	201
	75	4	70	IRRE0446	224

piano estraibile per elementi a giorno

open compartments pull-out shelf

Per elementi a giorno dove indicato. Finitura materico disponibile solo nelle varianti Bianco, Avana, Quarzo, Sabbia, Noce alabama, Rovere termotrattato, Perla, Argilla.

For open compartment where indicated. Textured finish available only in Bianco, Avana, Quarzo, Sabbia, Alabama Walnut, heat-treated Oak, Perla, Argilla.

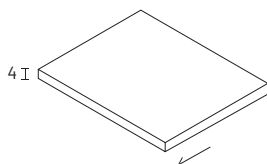

L W	SP TH	P D	CODICE CODE	Materico Textured finish	Lacc. opaco Matt lacq.
--------	----------	--------	----------------	-----------------------------	---------------------------

P 60	67	4	60	IRRE1434	205	306
------	----	---	----	----------	-----	-----

P 70	67	4	70	IRRE1436	212	319
------	----	---	----	----------	-----	-----

ATTREZZATURA INTERNA

Internal equipment

IDROBOX

cassetto interno

inner drawer

Finitura metallo antracite. Utilizzabile su basi cassetto dove specificato o su basi e colonne con ante battenti. Necessita l'utilizzo di cerniere con apertura a 180°.

Anthracite metal finish. For base units with drawers where indicated or base and tall units with hinged doors. Requires the use of 180° hinges.

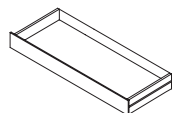

	L W	H H	P D	CODICE CODE	Prezzo Price
P 35	30	10,1	27,7	U9CI1011	140
	45	10,1	27,7	U9CI1021	144
	60	10,1	27,7	U9CI1031	148
	75	10,1	27,7	U9CI1041	153
	90	10,1	27,7	U9CI1051	156
P 50	30	10,1	40,7	U9CI1012	143
	45	10,1	40,7	U9CI1022	148
	60	10,1	40,7	U9CI1032	152
	75	10,1	40,7	U9CI1042	156
	90	10,1	40,7	U9CI1052	159
P 60	30	10,1	50,5	U9CI1015	150
	45	10,1	50,5	U9CI1025	154
	60	10,1	50,5	U9CI1035	158
	75	10,1	50,5	U9CI1045	162
	90	10,1	50,5	U9CI1055	166
P 70	30	10,1	60,5	U9CI1016	150
	45	10,1	60,5	U9CI1026	154
	60	10,1	60,5	U9CI1036	158
	75	10,1	60,5	U9CI1046	162
	90	10,1	60,5	U9CI1056	166

IDROBOX BASI
IDROBOX BASE UNITS

IDROBOX COLONNE E PENSILI
IDROBOX TALL AND WALL UNITS

IDROBOX ATTREZZATURA
IDROBOX EQUIPMENT

IDROBOX TOP E LAVATOI
IDROBOX TOPS AND WASHBASINS

INGRESSI
HALLWAY CABINETS

SCARPIERE
SHOE CABINETS

ACCESSORI
ACCESSORIES

cassetto interno per basi lavabo

inner drawer for washbasin units

Per basi lavabo con due ante battenti H 60 o 82,5 cm. Necessita l'utilizzo di cerniere con apertura a 180°.
For H 60 or 82,5 cm two hinged door washbasin units. Requires the use of 180° hinges.

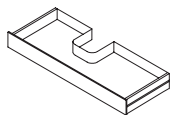

L W	H H	P D	CODICE CODE	Prezzo Price
--------	--------	--------	----------------	-----------------

P 50	60	10,1	40,7	U9CI0032	232
	75	10,1	40,7	U9CI0042	236
	90	10,1	40,7	U9CI0052	240

P 60	60	10,1	50,5	U9CI0035	243
	75	10,1	50,5	U9CI0045	247
	90	10,1	50,5	U9CI0055	269

P 70	60	10,1	60,5	U9CI0036	243
	75	10,1	60,5	U9CI0046	247
	90	10,1	60,5	U9CI0056	258

cestone interno

inner deep drawer

Per basi e colonne con ante battenti. Necessita l'utilizzo di cerniere con apertura a 180°.
For base and tall units with hinged doors. Requires the use of 180° hinges.

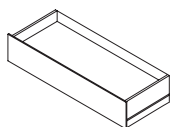

L W	H H	P D	CODICE CODE	Prezzo Price
--------	--------	--------	----------------	-----------------

P 35	30	18,8	27,7	U9CI1111	187
	45	18,8	27,7	U9CI1121	199
	60	18,8	27,7	U9CI1131	211
	75	18,8	27,7	U9CI1141	234
	90	18,8	27,7	U9CI1151	269

P 50	30	18,8	40,7	U9CI1112	199
	45	18,8	40,7	U9CI1122	211
	60	18,8	40,7	U9CI1132	223
	75	18,8	40,7	U9CI1142	246
	90	18,8	40,7	U9CI1152	281

P 60	30	18,8	50,5	U9CI1115	212
	45	18,8	50,5	U9CI1125	226
	60	18,8	50,5	U9CI1135	240
	75	18,8	50,5	U9CI1145	270
	90	18,8	50,5	U9CI1155	294

P 70	30	18,8	60,5	U9CI1116	212
	45	18,8	60,5	U9CI1126	226
	60	18,8	60,5	U9CI1136	240
	75	18,8	60,5	U9CI1146	270
	90	18,8	60,5	U9CI1156	294

ATTREZZATURA INTERNA

Internal equipment

IDROBOX

appendiabiti estraibile

pull-out clothes rail



P D	CODICE CODE	Prezzo Price
--------	----------------	-----------------

29,5	IRXTE001	50
------	----------	----

tubo appendiabiti

clothes rail



L W	CODICE CODE	Prezzo Price
--------	----------------	-----------------

30	IRXT0011	19
45	IRXT0021	20
60	IRXT0031	21
75	IRXT0041	22
90	IRXT0051	23

sanificatore

sanitizer device

Dispositivo per il trattamento dell'aria con sistema a LED UV. Posizionabile solo su coperchio. Alimentatore incluso. La gestione del posizionamento dell'alimentatore sarà a cura del cliente. Il sistema di accensione deve essere collegato ad un interruttore della rete elettrica della stanza.

Air treatment device with UV LED system, to be placed only on the top panel. Power supply included. Installing the power supply in the correct positions is the customer's responsibility. The switch-on system must be connected to a main switch in the room.

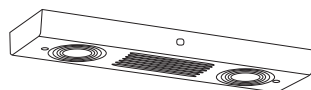

CODICE CODE	Prezzo Price
----------------	-----------------

IRXSA001	215
----------	-----

IDROBOX BASI
IDROBOX BASE UNITS

IDROBOX COLONNE E PENSILI
IDROBOX TALL AND WALL UNITS

IDROBOX ATTREZZATURA
IDROBOX EQUIPMENT

IDROBOX TOP E LAVATOI
IDROBOX TOPS AND WASHBASINS

INGRESSI
HALLWAY CABINETS

SCARPIERE
SHOE CABINETS

ACCESSORI
ACCESSORIES

ATTREZZATURA INTERNA

Internal equipment

IDROBOX

kit con ripiani e ganci portascopie

kit with shelves and broom rack

Finitura metallo antracite. Utilizzabile in colonne con profondità minima di 50 cm e larghezza minima di 60 cm. Fissaggio su fianchi interni.

Anthracite metal finish. For tall units with a minimum depth of 50 cm and a minimum width of 60 cm. Fixing on inner side panels.

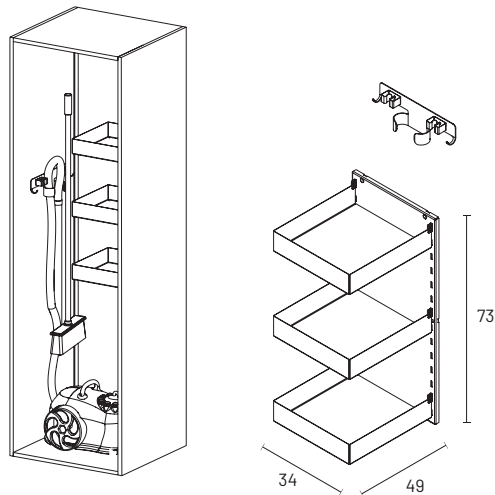

CODICE
CODE

Prezzo
Price

IRXKI610

266

kit con vaschette e ganci multiuso

kit with multipurpose trays and hooks

Finitura metallo antracite. Utilizzabile in basi e colonne con profondità minima di 35 cm e larghezza minima di 45 cm. Fissaggio sul lato interno dell'anta. Attenzione: non posizionabile in corrispondenza di ripiani o altri accessori interni.

Anthracite metal finish. For base units and tall units with a minimum depth of 35 cm and a minimum width of 45 cm. Fixing on the inside of the door. Attention: cannot be aligned with shelves or other internal accessories.

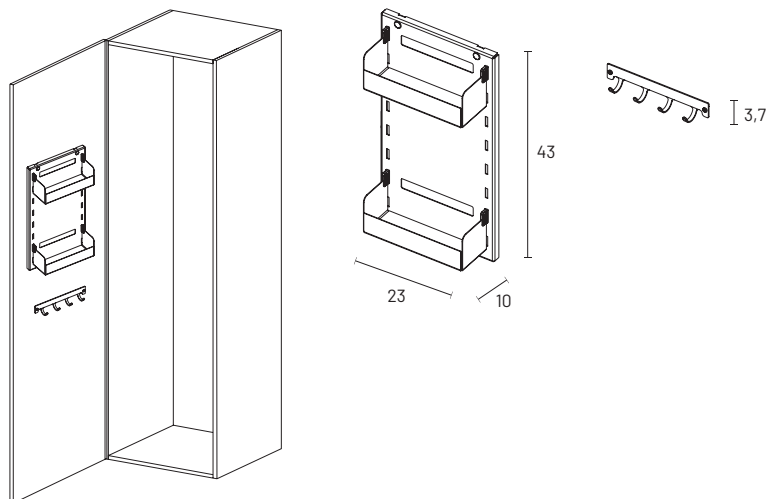

CODICE
CODE

Prezzo
Price

IRXKI400

112

ATTREZZATURA INTERNA

Internal equipment

IDROBOX

portascarpe estraibile

pull-out shoe rack

Finitura metallo antracite. Utilizzabile in basi e colonne con profondità minima di 60 cm e larghezza minima di 45 cm. Necessita l'utilizzo di cerniere con apertura a 180°.

Anthracite metal. For base units and tall units with a minimum depth of 60 cm and a minimum width of 45 cm. Requires the use of 180° hinges.

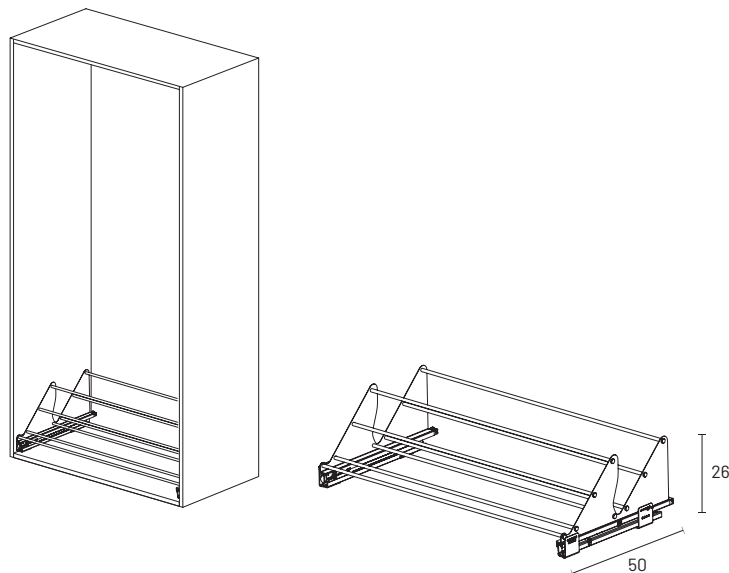

L W	CODICE CODE	Prezzo Price
--------	----------------	-----------------

45	IRXP0125	187
60	IRXP0135	194
75	IRXP0145	199
90	IRXP0155	205

IDROBOX BASI
IDROBOX BASE UNITS

IDROBOX COLONNE E PENSILI
IDROBOX TALL AND WALL UNITS

IDROBOX ATTREZZATURA
IDROBOX EQUIPMENT

IDROBOX TOP E LAVATOI
IDROBOX TOPS AND WASHBASINS

INGRESSI
HALLWAY CABINETS

SCARPIERE
SHOE CABINETS

ACCESSORI
ACCESSORIES

SPALLE DI FINITURA

finishing panels

IDROBOX

spalla al metro lineare
side panel per linear meter



H max 276 cm
max H 276 cm

P D	SP TH	CODICE CODE	Materico Textured finish	Lacc. opaco Matt lacq.
20	2,2	IRFL0100	23	50
35	2,2	IRFL0200	40	93
50	2,2	IRFL0400	58	125
60	2,2	IRFL0600	65	151
70	2,2	IRFL0700	76	174

BASAMENTI

Bases

IDROBOX

zoccolo al metro lineare

plinth per linear metre

Finitura di serie alluminio, nero, bianco oppure nelle colorazioni laccato opaco
Standard finishes: aluminium, black or white or coloured matt lacquers

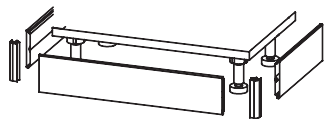

H H	CODICE CODE	Prezzo Price	Lacc. opaco Matt lacq.
6	UZBMZOC6	50	75

6	UZBMZOC6	50	75
---	----------	----	----

piede H 6 cm

H 6 cm feet

colore nero
black



H H	CODICE CODE	Prezzo Price
6	UZBM018	23

6	UZBM018	23
---	---------	----

IDROBOX BASI
IDROBOX BASE UNITS

IDROBOX COLONNE E PENSILI
IDROBOX TALL AND WALL UNITS

IDROBOX ATTREZZATURA
IDROBOX EQUIPMENT

IDROBOX TOP E LAVATOI
IDROBOX TOPS AND WASHBASINS

INGRESSI
HALLWAY CABINETS

SCARPIERE
SHOE CABINETS

ACCESSORI
ACCESSORIES

LED incasso verticale per pensili e colonne

Vertical built-in LED for wall units and tall units

LED colonne è disponibile solo il led interno. Alimentatore escluso, da aggiungere in base alla composizione.

External or internal vertical recessed LED on side. For tall units, only the internal LED is available. Power supply unit excluded; add according to composition.

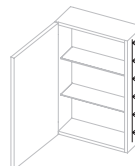

led esterno
external LED

H	Watt	CODICE	Prezzo
H	Watt	CODE	Price

30	4,3	U205071	48
45	6,5	U205072	53
60	8,6	U205073	58
75	10,8	U205074	66
90	13	U205075	72
105	15,1	U205076	79
120	17,3	U205077	86
135	19,4	U205078	96
150	21,6	U205079	102
180	25,9	U20507A	115
195	28,1	U20507B	123

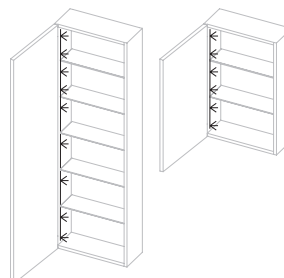

led interno
internal LED

30	4	U205081	54
45	6	U205082	61
60	8,5	U205083	65
75	10,5	U205084	73
90	12,5	U205085	79
105	15	U205086	86
120	17	U205087	93
135	19	U205088	102
150	21,5	U205089	110
180	25,5	U20508A	123
195	27,6	U20508B	129
210	29,7	U20508C	138

Luce calda 3000 K. Per il calcolo corretto sommare il prezzo delle luci LED nelle misure volute + il prezzo dell'alimentatore adatto.

Attenzione: la gestione del posizionamento dell'alimentatore sarà a cura del cliente. Il sistema di accensione deve essere collegato ad un interruttore della rete elettrica della stanza.

I LED per sponde cassetti hanno alimentatore incluso e non necessitano di collegamento a presa elettrica.

3000 K warm light. To calculate the price, add the cost of the LED lights in the desired sizes and the cost of the relevant power supply unit.

Note: installing the power supply unit in the correct position is the customer's responsibility. The switch-on system must be connected to a mains switch in the room.

Drawer sideboard LEDs come with a power supply unit included and do not require connection to an electrical socket.

LED incasso orizzontale per pensili

Horizontal built-in LED for wall units

LED incasso orizzontale esterno per pensili o interno per pensili ribalta. Alimentatore escluso, da aggiungere in base alla composizione

Horizontal built-in LED: external for wall units or on the inside for lift-up door wall units. Power supply unit excluded; add according to composition



L W	Watt Watt	CODICE CODE	Prezzo Price
30	4	U205091	48
45	6	U205092	53
60	8,5	U205093	58
75	10,5	U205094	66
90	12,5	U205095	72

LED per sponde cassetti/cestoni

Drawer/deep drawer sideboard LEDs

LED incasso per sponde Avantechyou Hettich. Dotate di batteria al litio ricaricabile e removibile alloggiata sul retro del cassetto.

Built-in LEDs for Hettich AvanTech YOU sideboards. Equipped with a rechargeable, removable lithium battery housed in the back of the drawer.



P D	CODICE CODE	Prezzo Price
35	U509021	172
50	U509023	183
60	U509024	186
70	U509025	186

Alimentatore

Power supply

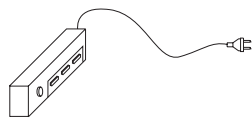

Watt Watt	CODICE CODE	Prezzo Price
15	U509011	37
20	U509012	44
30	U509013	64
50	U509014	70

Luce calda 3000 K. Per il calcolo corretto sommare il prezzo delle luci LED nelle misure volute + il prezzo dell'alimentatore adatto.

Attenzione: la gestione del posizionamento dell'alimentatore sarà a cura del cliente. Il sistema di accensione deve essere collegato ad un interruttore della rete elettrica della stanza.

I LED per sponde cassetti hanno alimentatore incluso e non necessitano di collegamento a presa elettrica.

3000 K warm light. To calculate the price, add the cost of the LED lights in the desired sizes and the cost of the relevant power supply unit.

Note: installing the power supply unit in the correct position is the customer's responsibility. The switch-on system must be connected to a mains switch in the room.

Drawer sideboard LEDs come with a power supply unit included and do not require connection to an electrical socket.

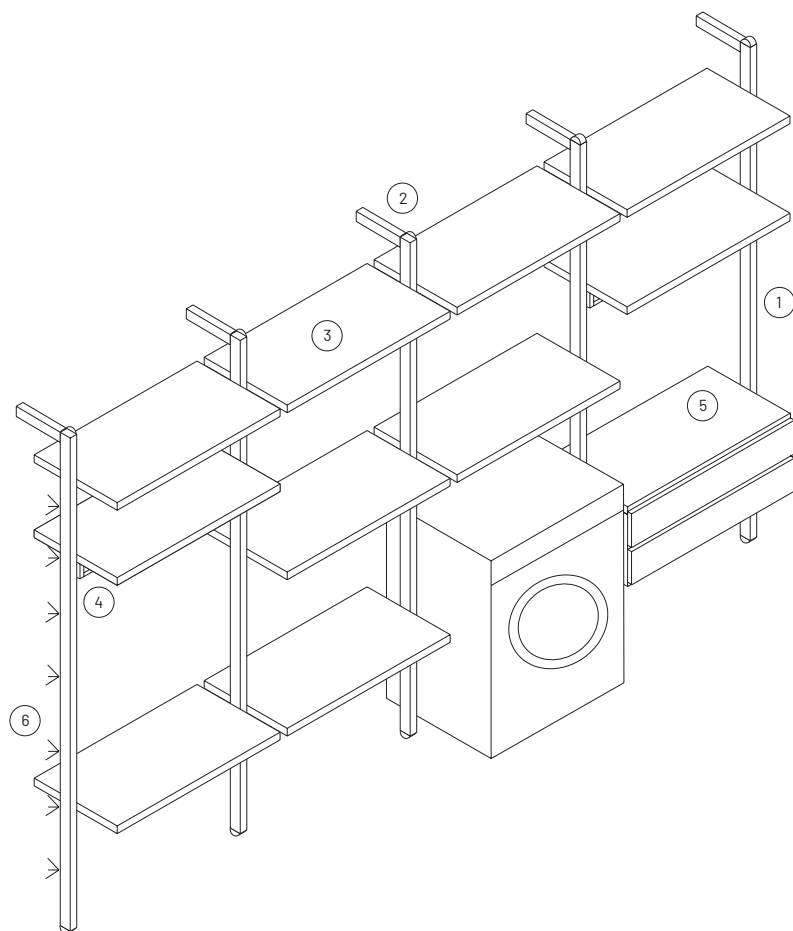

- ① **cremagliera**
rack
- ② **traverso**
crossbar
- ③ **ripiano**
shelf
- ④ **tubo appendiabiti**
clothes rail
- ⑤ **base sospesa**
Wall-mounted base units
- ⑥ **LED optional**
optional LED

CREMAGLIERE: in alluminio in finitura nera, disponibile con fissaggio terra-soffitto oppure a parete tramite traverso orizzontale. Nel caso in cui nella composizione non sia presente una base fissata a parete è necessario aggiungere un secondo traverso. La tenuta delle cremagliere, con la relativa attrezzatura, è garantita dall'utilizzo dei tasselli adeguati al tipo di parete. Pertanto la responsabilità delle operazioni di montaggio è totalmente a carico del cliente.

RIPIANI: realizzati in pannelli di particelle certificati CARB-2 sp. 40 mm con nobilitazione melaminica o laccati opachi. Completati di staffe di supporto. Portata massima per ripiano di 20 kg equamente distribuiti.

BASI SOSPESE: basi Idrobox H 45 cm, devono essere necessariamente fissate a parete.

ILLUMINAZIONE LED: 3000 K optional integrata nella cremagliera. Il sistema di accensione deve essere collegato ad un interruttore con accensione della rete elettrica della stanza oppure tramite dimmer e telecomando. La gestione del posizionamento dell'alimentatore sarà a cura del cliente.

RACKS: aluminum in black, available with floor-to-ceiling fastening or with wall fixing by means of a horizontal crossbar. If there isn't any base unit fixed to the wall, add a second crossbar. The stability of the racks, with the related equipment, is guaranteed by the use of suitable plugs according to the type of wall. Therefore, the responsibility for the assembly operations is fully borne by the customer.

SHELVES: made of CARB-2 certified 40 mm thick particleboard with melamine finish or matt lacquer. Equipped with support brackets. Maximum load per shelf of 20 kg equally distributed. **WALL-MOUNTED BASE UNITS:** H 45 cm Idrobox base units, must be fixed to the wall.

LED LIGHTING: 3000 K, optional, integrated with the rack. The lighting system must be connected to the mains in the room by means of a switch or dimmer and a remote control. The placement of the power supply will be the customer's own responsibility.

BAMBOO

Bamboo

IDROBOX

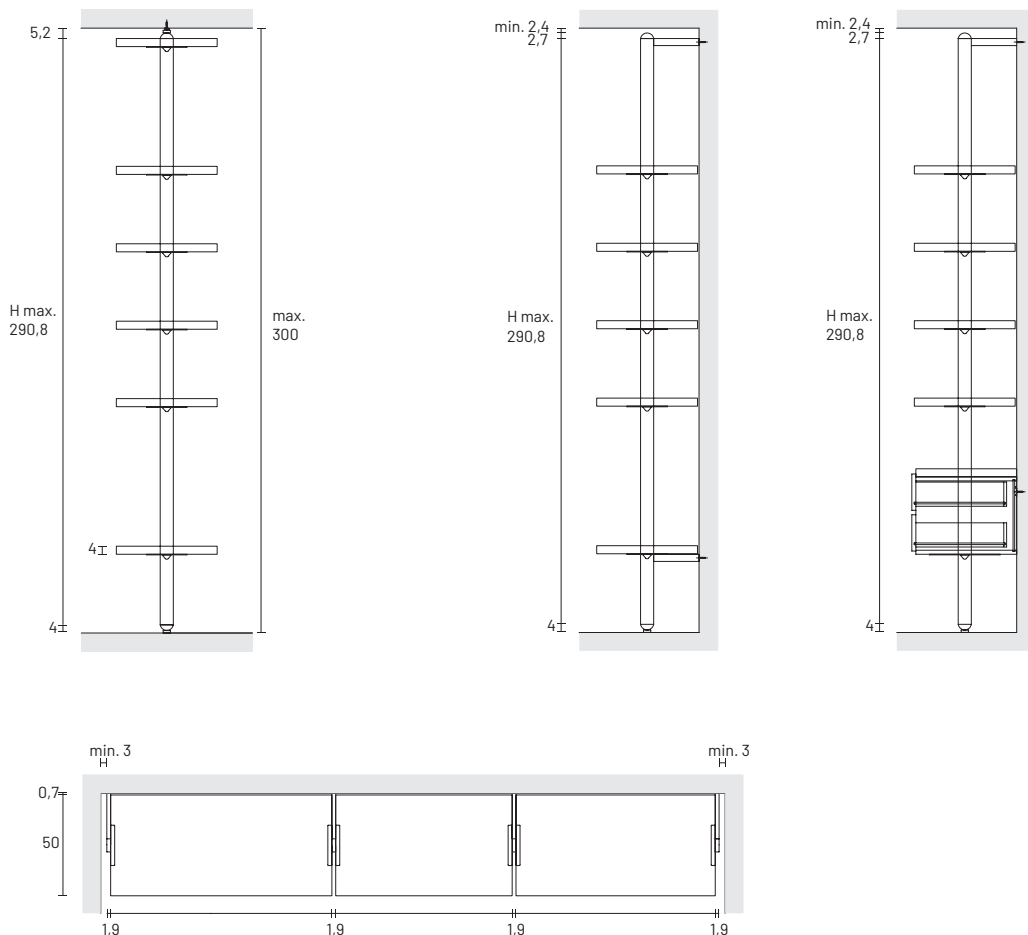

Per installazione terra-soffitto l'altezza massima del soffitto deve essere di 300 cm. Per determinare l'altezza esatta consigliamo di ripetere la misurazione in tre punti differenti dove andrà posizionata la composizione e considerare quella più bassa (tolleranza massima 1 cm).

Per il posizionamento della composizione in nicchia è necessario tenere una distanza minima di 3 cm tra l'ultimo montante e la parete.

For the floor-to-ceiling assembly, the maximum ceiling height is 300 cm. To calculate the exact height, we recommend taking the measurement at three different points where the composition will be placed and consider the lowest one (maximum tolerance of 1 cm).

For compositions installed in a niche, keep a minimum clearance of 3 cm between the wall and the last upright.

cremagliera a parete

wall rack

prezzi al ml
H max 290,8 cm
per lin.mt. price
max. H 290,8 cm



L W	P D	CODICE CODE	Prezzo Price
--------	--------	----------------	-----------------

n.1 traverso n.1 crosspiece	1,9	29	BABML432	344
--------------------------------	-----	----	----------	-----

n.2 traversi n.2 crosspieces	1,9	29	BABML433	485
---------------------------------	-----	----	----------	-----

cremagliera terra-soffitto

floor-to-ceiling rack

prezzi al ml
H max 290,8 cm
per lin.mt. price
max. H 290,8 cm



L W	P D	CODICE CODE	Prezzo Price
--------	--------	----------------	-----------------

	1,9	6,5	BABML43A	326
--	-----	-----	----------	-----

ripiano in legno sp. 4 cm

th 4 cm wooden shelf

portata massima 20 kg equamente distribuiti
maximum load 20 kg equally distributed

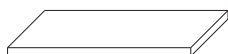

L W	P D	SP TH	CODICE CODE	Materico Textured finish	Lacc. opaco Matt lacq.
--------	--------	----------	----------------	-----------------------------	---------------------------

60	50	4	BARB1434	152	201
75	50	4	BARB1444	165	226
90	50	4	BARB1454	172	251
105	50	4	BARB1464	185	275
120	50	4	BARB1474	197	295

Finitura materico sp. 4 cm disponibile solo nelle varianti Bianco, Avana, Quarzo, Sabbia, Noce alabama, Rovere termotrattato, Perla, Argilla.

Th 4 cm textured finish available only in Bianco, Avana, Quarzo, Sabbia, Alabama Walnut, heat-treated Oak, Perla, Argilla.

BAMBOO

Bamboo

IDROBOX

base 1 cestone

1 deep drawer base unit

sommare sempre il prezzo del top
always add top panel price

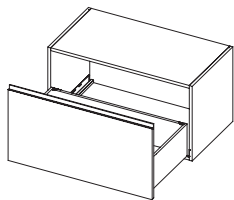

base 2 cassetti H 22,1

2 drawers H 22,1 base unit

sommare sempre il prezzo del top
always add top panel price

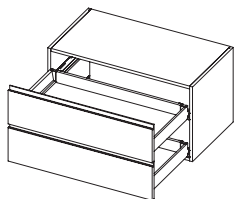

tubo appendiabiti

clothes rail

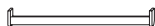

L W	H H	P D	CODICE CODE
--------	--------	--------	----------------

Materico Textured finish	Lacc. opaco Matt lacq.
-----------------------------	---------------------------

60	45	50	BABN1434
75	45	50	BABN1444
90	45	50	BABN1454
105	45	50	BABN1464
120	45	50	BABN1474

437	518
463	544
486	572
525	616
564	659

L W	H H	P D	CODICE CODE
--------	--------	--------	----------------

Materico Textured finish	Lacc. opaco Matt lacq.
-----------------------------	---------------------------

60	45	50	BABN2434
75	45	50	BABN2444
90	45	50	BABN2454
105	45	50	BABN2464
120	45	50	BABN2474

531	607
565	641
594	679
645	736
695	793

L W	CODICE CODE
--------	----------------

Prezzo Price

60	BAXT0031
75	BAXT0041
90	BAXT0051
105	BAXT0061
120	BAXT0071

18
19
20
21
22

IDROBOX BASI
IDROBOX BASE UNITS

IDROBOX COLONNE E PENSILI
IDROBOX TALL AND WALL UNITS

IDROBOX ATTREZZATURA
IDROBOX EQUIPMENT

IDROBOX TOP E LAVATOI
IDROBOX TOPS AND WASHBASINS

INGRESSI
HALLWAY CABINETS

SCARPIERE
SHOE CABINETS

ACCESSORI
ACCESSORIES

luce LED verticale per cremagliera

vertical LED light for rack

H max 290,8 cm (taglio a misura e montaggio a cura del cliente)

Max h. 290,8 cm (customization and assembly are the responsibility of the customer)



Watt Watt	CODICE CODE	Prezzo Price
--------------	----------------	-----------------

33	BAXBLI000A	171
----	------------	-----

alimentatore

power supply

possono essere collegate fino a 6 luci

max. 6 lights to be connected

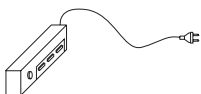

Watt Watt	CODICE CODE	Prezzo Price
--------------	----------------	-----------------

220 V

75	U509015	66
100	U509016	88

dimmer

dimmer

uno per ogni alimentatore

one per power supply

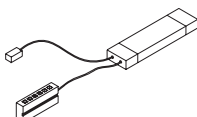

CODICE CODE	Prezzo Price
----------------	-----------------

BAXA0001	88
----------	----

telecomando

remote control

può gestire al massimo 6 dimmer

supports up to 6 dimmers

CODICE CODE	Prezzo Price
----------------	-----------------

BAXA0003	36
----------	----

TOP E LAVATOI

Tops and washbasins

TOP	P. 113
• LEGNO Wood	P. 114
• HPL	P. 118
• MARMO MINERALE Mineral marble	P. 122
LAVATOI E MISCELATORI WASHBASINS AND MIXER TAPS	P. 135
• LAVATOI Washbasins	P. 136
• MISCELATORI Mixer taps	P. 142

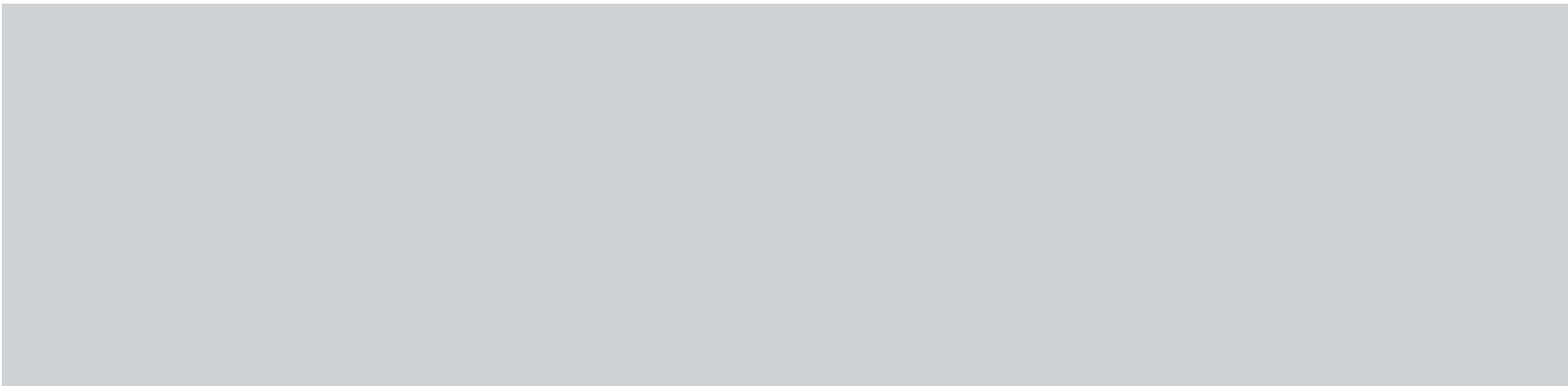

TOP

Tops

ACCESSORI
ACCESSORIES

SCARPIERE
SHOE CABINETS

INGRESSI
HALLWAY CABINETS

IDROBOX TOP E LAVATOI
IDROBOX TOPS AND WASHBASINS

IDROBOX ATTREZZATURA
IDROBOX EQUIPMENT

IDROBOX COLONNE E PENSILI
IDROBOX TALL AND WALL UNITS

IDROBOX BASI
IDROBOX BASE UNITS

LEGNO

Wood

Pannelli di particelle di legno certificati CARB-02 rivestiti con nobilitazione melaminica o laccati; bordatura poliuretanica idrorepellente.

Consigli di manutenzione: per la sua pulizia è bene utilizzare un panno umido ben strizzato. Il piano va pulito nel senso delle venature, in modo da togliere più efficacemente lo sporco dai pori, e asciugato con cura alla fine della pulizia. Si raccomanda sempre l'uso di panni morbidi non abrasivi. Non utilizzare prodotti abrasivi che potrebbero rigare la superficie. Non utilizzare prodotti a base di cera o siliconi in quanto la loro applicazione potrebbe formare degli aloni di diversa lucidità. Non utilizzare un panno troppo bagnato.

CARB-02-certified particleboard panels which have a melamine coating or are lacquered; water-repellent polyurethane edging.

Maintenance recommendations: use a damp, wrung-out cloth for cleaning. Clean the doors following the direction of the grain so as to effectively remove dirt from the pores. Dry carefully. Always use soft, non-abrasive cloths. Do not use abrasive products that could scratch the surface. Do not use products containing wax or silicone because they may leave dull marks. Do not use a wet cloth.

Foro per lavabo incasso sopra piano

Hole for over countertop washbasin

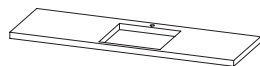

CODICE CODE	Prezzo Price
UMGPL54	75

Foro per lavabo incasso sopra piano su base angolo

Hole for over countertop washbasin on corner base unit



CODICE CODE	Prezzo Price
UMGPL55	115

Taglio inclinato o cambio profondità

Angled cut or depth change

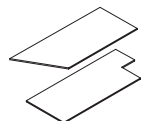

CODICE CODE	Prezzo Price
ULV153	129

LEGNO

Wood

MATERICI | TEXTURED FINISHES



Bianco

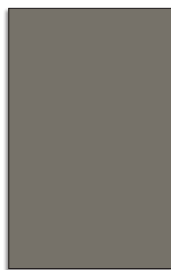

Quarzo



Sabbia



Avana



Perla



Argilla



Rovere virginia
Virginia oak



Noce alabama
Alabama walnut



Rovere termotrattato
Heat-treated oak

LACCATI OPACHI | MATT LACQUERS



9003
Bianco



9010
Panna

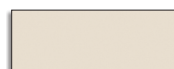

9001
Crema



1013
Fior di loto



9002
Ghiaccio



100
Sabbia

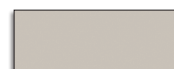

63
Tortora



68
Grigio perla



71
Light grey

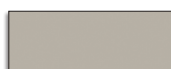

7044
Grigio seta

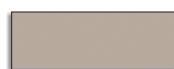

62
Canapa



61
Corda



72
Dark grey



7039
Grigio aston



101
Giallo senape



173
Bruciato



3003
Rosso



3005
Rosso bordeaux



102
Rosa cipria



74
Terracotta

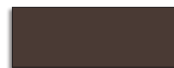

73
Moka



190
Verde pallido



103
Verde malva



104
Turchese



105
Oceano



106
Blu cobalto



246
Grigio Garda



107
Celeste



76
Carta da zucchero



7031
Grigio blu



7016
Grigio antracite



9017
Nero

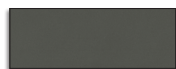

Titanio



Nichel



Piombo

Laccato a campione/RAL con maggiorazione del 20%.

20% surcharge for custom colour/RALs.

IDROBOX BASI
IDROBOX BASE UNITS

IDROBOX COLONNE E PENSILI
IDROBOX TALL AND WALL UNITS

IDROBOX ATTREZZATURA
IDROBOX EQUIPMENT

IDROBOX TOP E LAVATOI
IDROBOX TOPS AND WASHBASINS

INGRESSI
HALLWAY CABINETS

SCARPIERE
SHOE CABINETS

ACCESSORI
ACCESSORIES

PIANI AL METRO LINEARE

Tops per linear metre

LEGNO

Wood

Piano al metro lineare sp. 2,2 cm

Top per linear metre 2,2 cm th

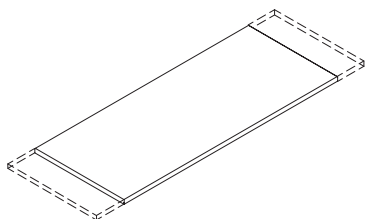

L max 270 cm
Max. W 270 cm

Piano al metro lineare sp. 4 cm

Top per linear metre 4 cm th

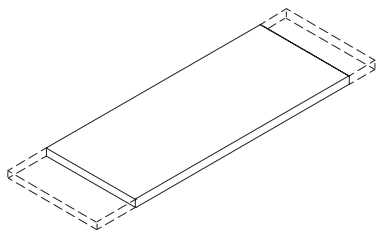

L max 270 cm
Max. W 270 cm

Piano per base angolo sp. 2,2 cm

Top 2,2 cm th for corner base unit

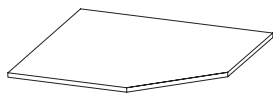

Piano per base angolo sp. 4 cm

Top 4 cm th for corner base unit

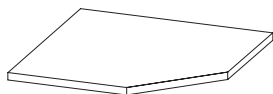

SP TH	P D	CODICE CODE
----------	--------	----------------

Materico Textured finish	Lacc. opaco Matt lacq.
-----------------------------	---------------------------

2,2	20	U6450201
2,2	35	U6450202
2,2	50	U6450205
2,2	60	U6450206
2,2	70	U6450207

96	133
131	208
167	283
192	332
214	383

SP TH	P D	CODICE CODE
----------	--------	----------------

Materico Textured finish	Lacc. opaco Matt lacq.
-----------------------------	---------------------------

4	20	U6450301
4	35	U6450302
4	50	U6450305
4	60	U6450306
4	70	U6450307

126	150
179	237
189	324
205	382
237	440

L W	SP TH	P D	CODICE CODE
--------	----------	--------	----------------

Materico Textured finish	Lacc. opaco Matt lacq.
-----------------------------	---------------------------

82	2,2	82	U6452277
92	2,2	92	U6452288
102	2,2	102	U6452299

299	362
323	386
353	427

L W	SP TH	P D	CODICE CODE
--------	----------	--------	----------------

Materico Textured finish	Lacc. opaco Matt lacq.
-----------------------------	---------------------------

82	4	82	U6452377
92	4	92	U6452388
102	4	102	U6452399

303	369
330	393
360	432

Finitura materico sp. 4 cm disponibile solo nelle varianti Bianco, Avana, Quarzo, Sabbia, Noce alabama, Rovere termotrattato, Perla, Argilla.
Spessore 2,2 cm non disponibile per basi lavabo.

Th 4 cm textured finish available only in Bianco, Avana, Quarzo, Sabbia, Alabama Walnut, heat-treated Oak, Perla, Argilla.
2,2 cm th not available for washbasin units.

GAMBONE TERMINALE

End side panel

LEGNO

Wood

gambone terminale
end side panel

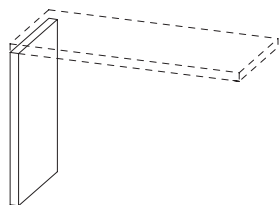

ripiano con traversa per gambone
shelf with back panel for supporting side panel

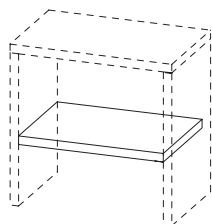

cestone portabiancheria con ruote
laundry drawer on wheels

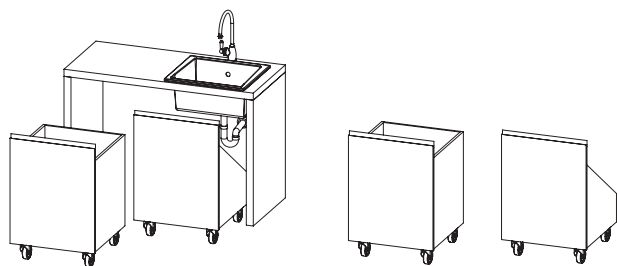

H H	SP TH	P D	CODICE CODE
--------	----------	--------	----------------

Materico Textured finish	Lacc. opaco Matt lacq.
-----------------------------	---------------------------

P 50	88,5	2,2	50	IRPAG724
	88,5	4	50	IRPAG744

184	253
205	281

P 60	88,5	2,2	60	IRPAG726
	88,5	4	60	IRPAG746

202	285
225	316

P 70	88,5	2,2	70	IRPAG727
	88,5	4	70	IRPAG747

221	310
243	349

L W	SP TH	P D	CODICE CODE
--------	----------	--------	----------------

Materico Textured finish	Lacc. opaco Matt lacq.
-----------------------------	---------------------------

P 50	67	4	50	IRRP0444
	82	4	50	IRRP0454

133	226
155	266

P 60	67	4	60	IRRP0446
	82	4	60	IRRP0456

143	267
168	314

P 70	67	4	70	IRRP0447
	82	4	70	IRRP0457

158	294
194	360

L W	H H	P D	CODICE CODE
--------	--------	--------	----------------

Materico Textured finish	Lacc. opaco Matt lacq.
-----------------------------	---------------------------

per lavabo
for washbasin

60	88,5	60	IRCS1736
60	88,5	60	IRCS2736

435	555
476	609

Finitura materico sp. 4 cm disponibile solo nelle varianti Bianco, Avana, Quarzo, Sabbia, Noce alabama, Rovere termotrattato, Perla, Argilla.
Spessore 2,2 cm non disponibile per basi lavabo.

Th 4 cm textured finish available only in Bianco, Avana, Quarzo, Sabbia, Alabama Walnut, heat-treated Oak, Perla, Argilla.
2,2 cm th not available for washbasin units.

IDROBOX BASI
IDROBOX BASE UNITS

IDROBOX COLONNE E PENSILI
IDROBOX TALL AND WALL UNITS

IDROBOX ATTREZZATURA
IDROBOX EQUIPMENT

IDROBOX TOP E LAVATOI
IDROBOX TOPS AND WASHBASINS

INGRESSI
HALLWAY CABINETS

SCARPIERE
SHOE CABINETS

ACCESSORI
ACCESSORIES

HPL

HPL

Il top in laminato è costituito da un pannello di particelle di legno (classe e1) idrorepellente rivestito da laminato plastico ad alta pressione (hpl).

Consigli di manutenzione: la pulizia va effettuata con una spugna bagnata con un normale detergente liquido. Da evitare sono i prodotti molto abrasivi, le pagliette in acciaio che potrebbero rigare la superficie e forti prodotti chimici e sanitari (candeggina, acidi ecc) che potrebbero provocare decolorazioni. Non lasciare mai alcun liquido depositato sulla superficie per lungo tempo. Non appoggiare ferri da stiro o qualunque altra fonte di calore, onde evitare delle bruciature e screpolature del laminato.

Laminate tops are made from water-repellent particleboard panels (class E1), clad with plastic HPL. Maintenance recommendations: clean the surface with a sponge and normal liquid detergent. Do not use abrasive cleaning products, steel wool scouring pads which may scratch the surface, or strong chemical/cleaning products (bleach, acid, etc.) as they may cause discolouration. Never leave liquids on the surface for a prolonged period. Do not rest irons or any other heat source on the surface to prevent burns and cracking on the laminate.



Bianco



Statuario

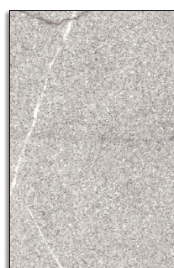

Pietra piacentina



Grafite



Ossido grigio



Ossido antracite

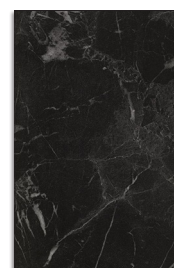

Marquinia

Foro per lavabo incasso sopra piano

Hole for over countertop washbasin

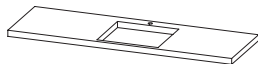

CODICE CODE	Prezzo Price
UMGPL92	115

Foro per lavabo incasso sopra piano su base angolo

Hole for over countertop washbasin on corner base unit

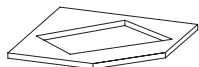

CODICE CODE	Prezzo Price
UMGPL93	115

Taglio inclinato o cambio profondità

Angled cut or depth change

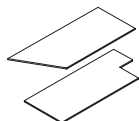

CODICE CODE	Prezzo Price
ULV194	173

PIANI AL METRO LINEARE

Tops per linear metre

HPL
HPL

Piano al metro lineare sp. 2 cm

Top per linear metre 2 cm th

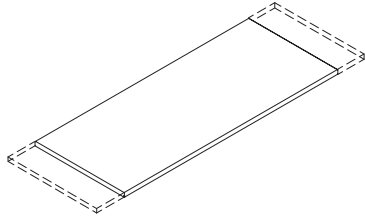

L max 210,4 cm
Max. W 210,4 cm

Piano al metro lineare sp. 4 cm

Top per linear metre 4 cm th

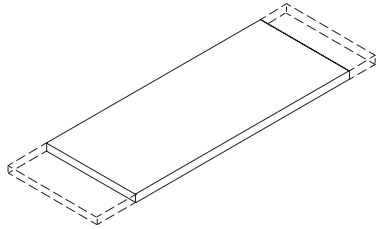

L max 210,4 cm
Max. W 210,4 cm

Piano per base angolo sp. 2 cm

Top 2 cm th for corner base unit



Piano per base angolo sp. 4 cm

Top 4 cm th for corner base unit

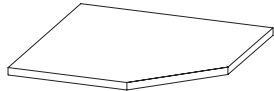

SP TH	P D	CODICE CODE	HPL HPL
-------	-----	-------------	---------

2	20	U6440201	181
2	35	U6440202	193
2	50	U6440205	216
2	60	U6440206	223
2	70	U6440207	272

SP TH	P D	CODICE CODE	HPL HPL
-------	-----	-------------	---------

4	20	U6440301	186
4	35	U6440302	198
4	50	U6440305	211
4	60	U6440306	228
4	70	U6440307	279

L W	SP TH	P D	CODICE CODE	HPL HPL
-----	-------	-----	-------------	---------

82	2	82	U6441277	350
92	2	92	U6441288	374
102	2	102	U6441299	415

L W	SP TH	P D	CODICE CODE	HPL HPL
-----	-------	-----	-------------	---------

82	4	82	U6441377	357
92	4	92	U6441388	380
102	4	102	U6441399	421

Spessore 2,2 cm non disponibile per basi lavabo.

2,2 cm th not available for washbasin units.

IDROBOX BASI
IDROBOX BASE UNITS

IDROBOX COLONNE E PENSILI
IDROBOX TALL AND WALL UNITS

IDROBOX ATTREZZATURA
IDROBOX EQUIPMENT

IDROBOX TOP E LAVATOI
IDROBOX TOPS AND WASHBASINS

INGRESSI
HALLWAY CABINETS

SCARPIERE
SHOE CABINETS

ACCESSORI
ACCESSORIES

GAMBONE TERMINALE

End side panel

HPL
HPL

gambone terminale
end side panel

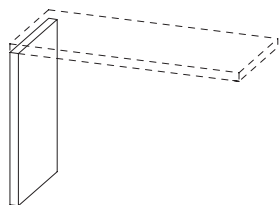

H H	SP TH	P D	CODICE CODE	HPL HPL
--------	----------	--------	----------------	------------

P 50	88,5	2	50	IRPAG1724	209
	88,5	4	50	IRPAG1744	295

P 60	88,5	2	60	IRPAG1726	239
	88,5	4	60	IRPAG1746	337

P 70	88,5	2	70	IRPAG1727	281
	88,5	4	70	IRPAG1747	374

ripiano con traversa per gambone
shelf with back panel for supporting side panel

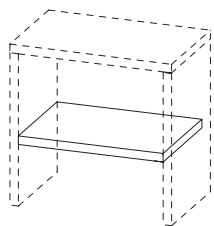

L W	SP TH	P D	CODICE CODE	HPL HPL
--------	----------	--------	----------------	------------

P 50	67	4	50	IRRP1444	158
	82	4	50	IRRP1454	185

P 60	67	4	60	IRRP1446	173
	82	4	60	IRRP1456	200

P 70	67	4	70	IRRP1447	189
	82	4	70	IRRP1457	232

cestone portabiancheria con ruote
laundry drawer on wheels

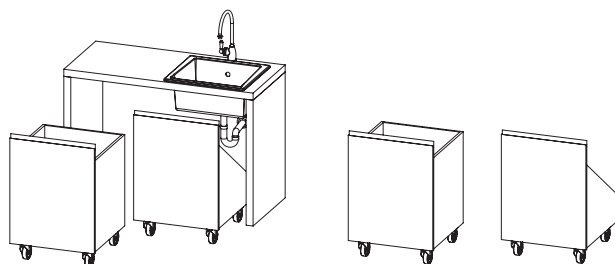

L W	H H	P D	CODICE CODE	Materico Textured finish	Lacc. opaco Matt lacq.
--------	--------	--------	----------------	-----------------------------	---------------------------

per lavabo for washbasin	60	88,5	60	IRCS1736	435	555
	60	88,5	60	IRCS2736	476	609

Spessore 2,2 cm non disponibile per basi lavabo.

2,2 cm th not available for washbasin units.

ACCESSORI

Accessories

alzatina in alluminio al m.l.

aluminium splashback per linear metre

L max 390 cm

max W 390 cm

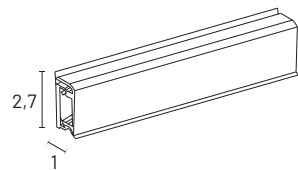

CODICE
CODE

Prezzo
Price

UAL6450

24

Staffa per top sospesi

Bracket for wall-mounted tops

Finitura nero opaco

Matt black finish

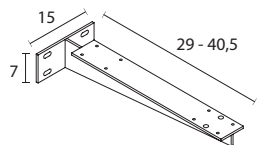

P
D

CODICE
CODE

Prezzo
Price

35

UZ3010

62

50

UZ3020

61

staffa angolo

corner bracket

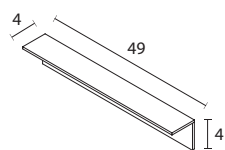

CODICE
CODE

Prezzo
Price

UZ320

38

IDROBOX BASI
IDROBOX BASE UNITS

IDROBOX COLONNE E PENSILI
IDROBOX TALL AND WALL UNITS

IDROBOX ATTREZZATURA
IDROBOX EQUIPMENT

IDROBOX TOP E LAVATOI
IDROBOX TOPS AND WASHBASINS

INGRESSI
HALLWAY CABINETS

SCARPIERE
SHOE CABINETS

ACCESSORI
ACCESSORIES

MARMO MINERALE

Mineral marble

Composto solido di cariche minerali naturali e polimeri leganti di alta qualità, il film protettivo (gelcoat) che lo riveste superficialmente e che gli dona brillantezza e lucidità, consente di ottenere un'ottima resistenza chimico-fisica nel tempo.

Installazione: per una corretta installazione dei piani in marmo minerale devono essere rigorosamente utilizzati siliconi neutri trasparenti non acetici, per evitare la corrosione della superficie.

Pulizia e manutenzione quotidiana: per la pulizia del piano in marmo minerale, dalle macchie dal calcare e dallo sporco, è sufficiente e consigliato pulire la superficie con acqua saponata o comuni detergenti non abrasivi; utilizzare spugna non abrasiva o panno di cotone ed infine asciugare con panno morbido.

Consigliamo di evitare l'utilizzo di abrasivi e prodotti come ad esempio: trielina, acetone e solventi in genere.

Mineral marble is a solid compound of natural mineral load and high-quality polyester linkers. A gelcoat film covers the surface, giving it a bright, glossy finish and ensures good chemical and physical resistance over time.

Installation: when installing mineral marble tops, use clear, neutral, not-acetic silicones only, to prevent surfaces from corroding.

Daily cleaning and maintenance: to clean limescale and dirt from mineral marble tops, use soapy water or a non-abrasive household detergent. Use a cotton cloth or non-abrasive sponge and dry with a soft cloth.

We recommend avoiding the use of abrasives and products such as trichlorethylene, acetone and solvents in general.

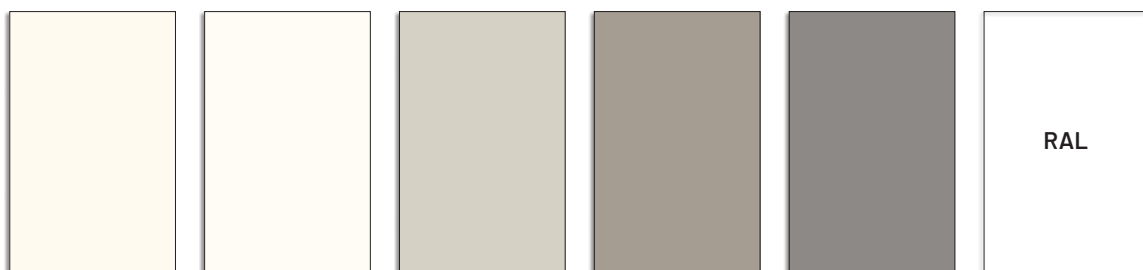

Bianco lucido
Glossy white

Bianco opaco
Matt white

Ghiaccio opaco
Matt Ghiaccio

Tortora opaco
Matt Tortora

Grigio opaco
Matt Grigio

Campione RAL (con maggiorazione)
RAL sample (with surcharge)

Foro per lavabo incasso sopra piano

Hole for over countertop washbasin

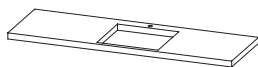

CODICE CODE	Prezzo Price
UMGPL42	99

Taglio inclinato o cambio profondità

Angled cut or depth change

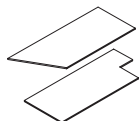

CODICE CODE	Prezzo Price
ULV143	152

I piani in marmo minerale sono disponibili anche in colorazione a campione/RAL con maggiorazione del 20% rispetto alla finitura colore.

Mineral marble tops are also available in custom/RAL color with a 20% surcharge to the color finish.

PIANI AL METRO LINEARE

Tops per linear metre

MARMO MINERALE

Mineral marble

Piano al metro lineare sp. 1,2 cm

Top per linear metre 1,2 cm th

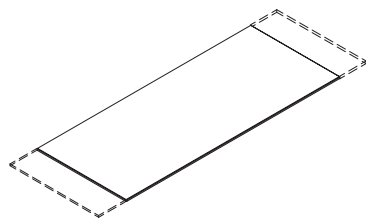

L max 240,6 cm
W max 240,6 cm

Alzatina al metro lineare sp. 1,2 cm

Splashback per linear metre 1,2 cm th

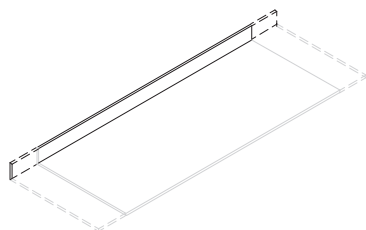

L max 240,6 cm
W max 240,6 cm

Altezza minima alzatina: 6 cm.

Minimum splashback height: 6 cm.

SP TH	P D	CODICE CODE
----------	--------	----------------

1,2	20	U6470101
1,2	35	U6470102
1,2	50	U6470105
1,2	60	U6470106
1,2	70	U6470107

Bianco White	Colore Color
-----------------	-----------------

318	414
374	486
421	547
505	656
589	765

H H	SP TH	CODICE CODE
--------	----------	----------------

6	1,2	UAL6470
10	1,2	UAL6471

Bianco White	Colore Color
-----------------	-----------------

165	213
165	213

IDROBOX BASI
IDROBOX BASE UNITS

IDROBOX COLONNE E PENSILI
IDROBOX TALL AND WALL UNITS

IDROBOX ATTREZZATURA
IDROBOX EQUIPMENT

IDROBOX TOP E LAVATOI
IDROBOX TOPS AND WASHBASINS

INGRESSI
HALLWAY CABINETS

SCARPIERE
SHOE CABINETS

ACCESSORI
ACCESSORIES

PIANI INTEGRATI p. 35-50 cm

Built-in tops d 35-50 cm

MARMO MINERALE

Mineral marble

vasca singola CENTRALE

CENTRAL single basin

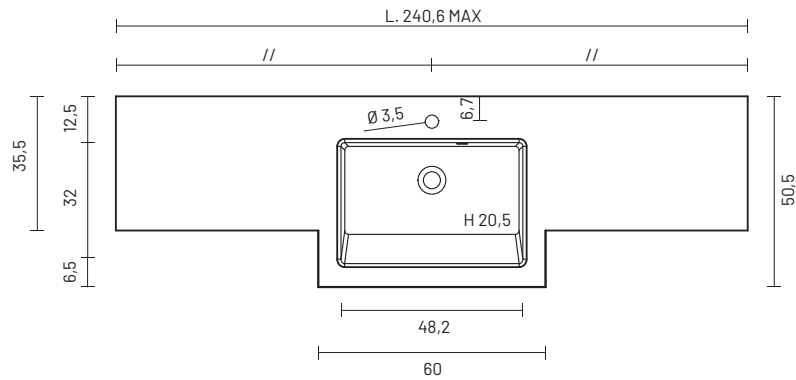
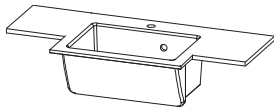

vasca singola LATERALE

SIDE single basin

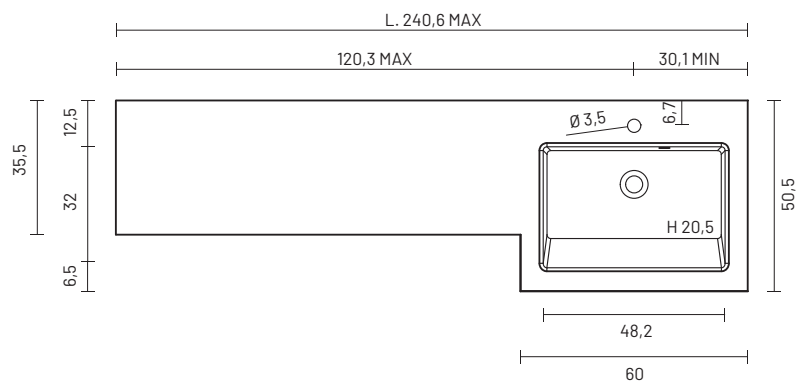
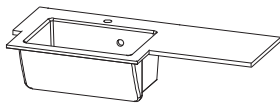

asse in pino

pine wood washing board

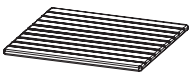

L W	SP TH	P D	CODICE CODE
--------	----------	--------	----------------

Bianco White	Colore Color
-----------------	-----------------

60	1,2	35	U647A2A02
75	1,2	35	U647A2B02
90	1,2	35	U647A2C02
105	1,2	35	U647A2D02
120	1,2	35	U647A2E02
135	1,2	35	U647A2F02
150	1,2	35	U647A2G02
165	1,2	35	U647A2H02
180	1,2	35	U647A2I02
195	1,2	35	U647A2L02
210	1,2	35	U647A2M02
240	1,2	35	U647A2N02

897	1.166
902	1.173
908	1.179
962	1.251
968	1.259
1.019	1.327
1.025	1.334
1.103	1.434
1.109	1.441
1.115	1.450
1.194	1.552
1.201	1.560

L W	SP TH	P D	CODICE CODE
--------	----------	--------	----------------

Bianco White	Colore Color
-----------------	-----------------

60	1,2	35	U647A3A02
75	1,2	35	U647A3B02
90	1,2	35	U647A3C02
105	1,2	35	U647A3D02
120	1,2	35	U647A3E02
135	1,2	35	U647A3F02
150	1,2	35	U647A3G02
165	1,2	35	U647A3H02
180	1,2	35	U647A3I02
195	1,2	35	U647A3L02
210	1,2	35	U647A3M02
240	1,2	35	U647A3N02

958	1.246
963	1.252
969	1.260
1.028	1.335
1.032	1.342
1.087	1.416
1.092	1.423
1.176	1.528
1.181	1.536
1.187	1.544
1.272	1.653
1.284	1.670

L W	H H	CODICE CODE
--------	--------	----------------

Prezzo Price

46,3	35	IRASSE01P
------	----	-----------

63

Specificare sempre asse scarico e asse rubinetto (qualora diversi).
Foro rubinetto incluso di serie.
Piletta di scarico esclusa (pagina 140).

Always specify the drain and tap axes (if different).
 Tap hole included.
 Drain plug excluded (page 140).

PIANI INTEGRATI p. 50 cm

Built-in tops d 50 cm

MARMO MINERALE

Mineral marble

vasca singola CENTRALE

CENTRAL single basin

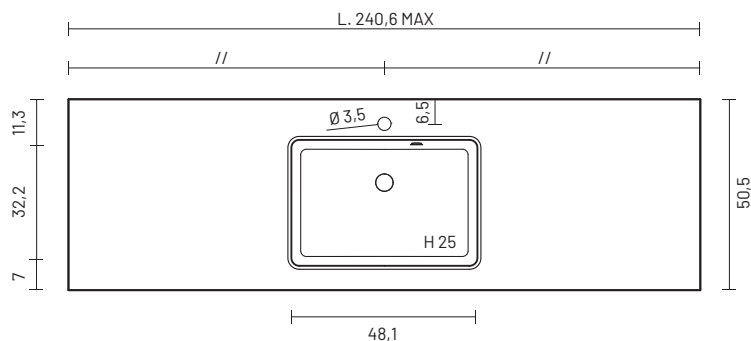
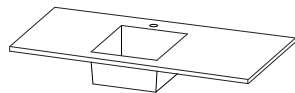

vasca singola LATERALE

SIDE single basin

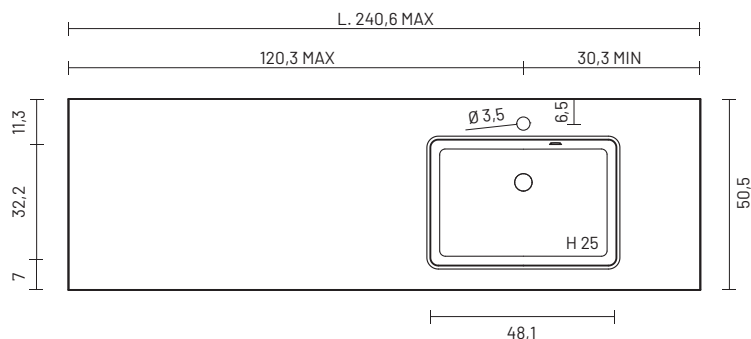
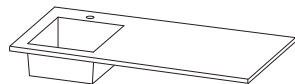

asse in pino

pine wood washing board



Specificare sempre asse scarico e asse rubinetto (qualora diversi).
Foro rubinetto incluso di serie.
Piletta di scarico esclusa (pagina 140).

Always specify the drain and tap axes (if different).
 Tap hole included.
 Drain plug excluded (page 140).

L W	SP TH	P D	CODICE CODE
--------	----------	--------	----------------

Bianco White	Colore Color
-----------------	-----------------

60	1,2	50	U647A2A05
75	1,2	50	U647A2B05
90	1,2	50	U647A2C05
105	1,2	50	U647A2D05
120	1,2	50	U647A2E05
135	1,2	50	U647A2F05
150	1,2	50	U647A2G05
165	1,2	50	U647A2H05
180	1,2	50	U647A2I05
195	1,2	50	U647A2L05
210	1,2	50	U647A2M05
240	1,2	50	U647A2N05

798	1.035
801	1.042
806	1.047
860	1.118
866	1.125
870	1.131
874	1.137
998	1.298
1.004	1.305
1.010	1.312
1.088	1.414
1.093	1.423

L W	SP TH	P D	CODICE CODE
--------	----------	--------	----------------

Bianco White	Colore Color
-----------------	-----------------

60	1,2	50	U647A3A05
75	1,2	50	U647A3B05
90	1,2	50	U647A3C05
105	1,2	50	U647A3D05
120	1,2	50	U647A3E05
135	1,2	50	U647A3F05
150	1,2	50	U647A3G05
165	1,2	50	U647A3H05
180	1,2	50	U647A3I05
195	1,2	50	U647A3L05
210	1,2	50	U647A3M05
240	1,2	50	U647A3N05

852	1.106
856	1.113
860	1.118
918	1.194
924	1.200
928	1.206
933	1.213
1.064	1.383
1.071	1.390
1.075	1.398
1.159	1.507
1.171	1.522

L W	H H	CODICE CODE
--------	--------	----------------

Prezzo Price

46,3	35	IRASSE01P
------	----	-----------

63

IDROBOX BASI
IDROBOX BASE UNITS

IDROBOX COLONNE E PENSILI
IDROBOX TALL AND WALL UNITS

IDROBOX ATTREZZATURA
IDROBOX EQUIPMENT

IDROBOX TOP E LAVATOI
IDROBOX TOPS AND WASHBASINS

INGRESSI
HALLWAY CABINETS

SCARPIERE
SHOE CABINETS

ACCESSORI
ACCESSORIES

PIANI INTEGRATI p. 60 cm - vasca piccola

Built-in tops d 60 cm - small basin

MARMO MINERALE

Mineral marble

vasca singola CENTRALE

CENTRAL single basin

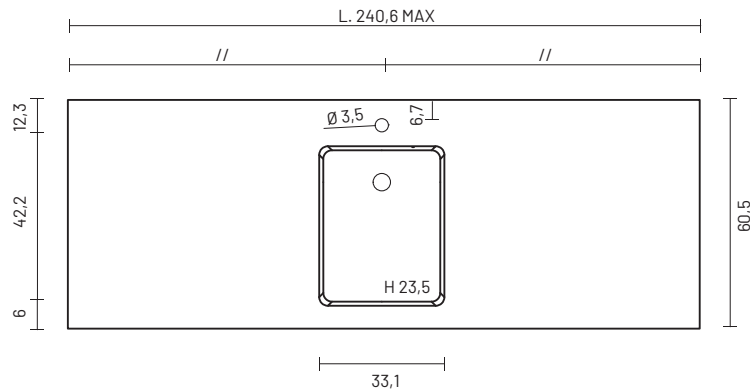
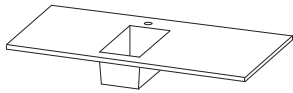

L W	SP TH	P D	CODICE CODE
--------	----------	--------	----------------

Bianco White	Colore Color
-----------------	-----------------

60	1,2	60	U647A4A06
75	1,2	60	U647A4B06
90	1,2	60	U647A4C06
105	1,2	60	U647A4D06
120	1,2	60	U647A4E06
135	1,2	60	U647A4F06
150	1,2	60	U647A4G06
165	1,2	60	U647A4H06
180	1,2	60	U647A4I06
195	1,2	60	U647A4L06
210	1,2	60	U647A4M06
240	1,2	60	U647A4N06

778	1.011
782	1.017
819	1.063
859	1.117
925	1.201
967	1.257
1.037	1.347
1.075	1.397
1.142	1.484
1.186	1.542
1.260	1.637
1.366	1.775

vasca singola LATERALE

SIDE single basin

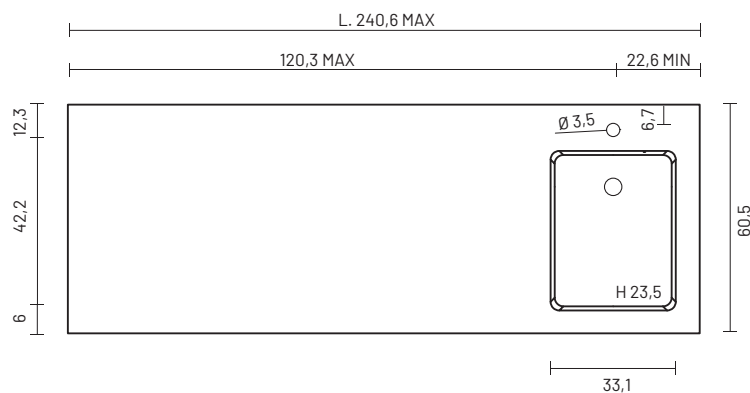
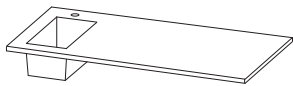

L W	SP TH	P D	CODICE CODE
--------	----------	--------	----------------

Bianco White	Colore Color
-----------------	-----------------

60	1,2	60	U647A5A06
75	1,2	60	U647A5B06
90	1,2	60	U647A5C06
105	1,2	60	U647A5D06
120	1,2	60	U647A5E06
135	1,2	60	U647A5F06
150	1,2	60	U647A5G06
165	1,2	60	U647A5H06
180	1,2	60	U647A5I06
195	1,2	60	U647A5L06
210	1,2	60	U647A5M06
240	1,2	60	U647A5N06

831	1.079
836	1.086
873	1.136
917	1.193
987	1.281
1.031	1.340
1.105	1.437
1.146	1.490
1.217	1.582
1.263	1.642
1.341	1.743
1.462	1.900

asse in pino

pine wood washing board

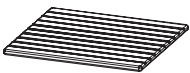

L W	H H	CODICE CODE
--------	--------	----------------

Prezzo Price

31,3	35	IRASSE00P
------	----	-----------

63

Specificare sempre asse scarico e asse rubinetto (qualora diversi).
Foro rubinetto incluso di serie.
Piletta di scarico esclusa (pagina 140).

Always specify the drain and tap axes (if different).
 Tap hole included.
 Drain plug excluded (page 140).

PIANI INTEGRATI p. 60 cm

Built-in tops d 60 cm

MARMO MINERALE

Mineral marble

vasca singola CENTRALE

CENTRAL single basin

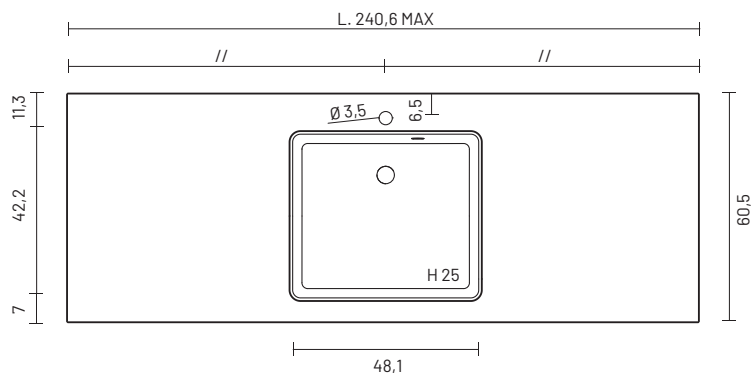
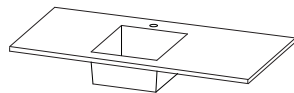

vasca singola LATERALE

SIDE single basin

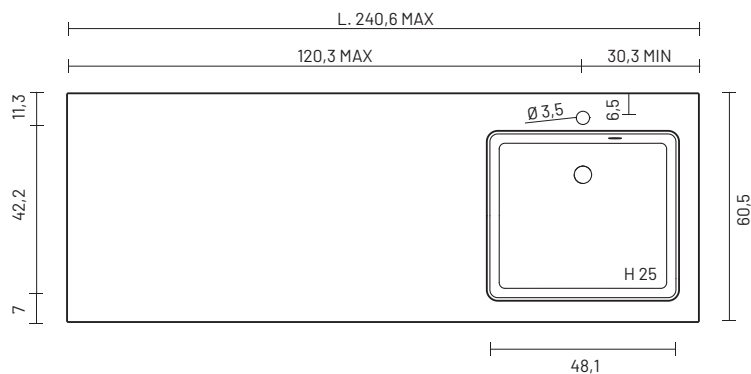
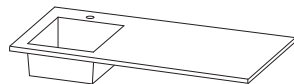

asse in pino

pine wood washing board

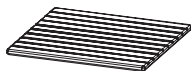

Specificare sempre asse scarico e asse rubinetto (qualora diversi).
Foro rubinetto incluso di serie.
Piletta di scarico esclusa (pagina 140).

Always specify the drain and tap axes (if different).
 Tap hole included.
 Drain plug excluded (page 140).

L W	SP TH	P D	CODICE CODE
--------	----------	--------	----------------

Bianco White	Colore Color
-----------------	-----------------

60	1,2	60	U647A6A06
75	1,2	60	U647A6B06
90	1,2	60	U647A6C06
105	1,2	60	U647A6D06
120	1,2	60	U647A6E06
135	1,2	60	U647A6F06
150	1,2	60	U647A6G06
165	1,2	60	U647A6H06
180	1,2	60	U647A6I06
195	1,2	60	U647A6L06
210	1,2	60	U647A6M06
240	1,2	60	U647A6N06

970	1.261
975	1.267
981	1.275
1.057	1.374
1.062	1.381
1.141	1.482
1.146	1.490
1.261	1.639
1.267	1.647
1.274	1.656
1.398	1.817
1.307	1.699

L W	SP TH	P D	CODICE CODE
--------	----------	--------	----------------

Bianco White	Colore Color
-----------------	-----------------

60	1,2	60	U647A7A06
75	1,2	60	U647A7B06
90	1,2	60	U647A7C06
105	1,2	60	U647A7D06
120	1,2	60	U647A7E06
135	1,2	60	U647A7F06
150	1,2	60	U647A7G06
165	1,2	60	U647A7H06
180	1,2	60	U647A7I06
195	1,2	60	U647A7L06
210	1,2	60	U647A7M06
240	1,2	60	U647A7N06

966	1.254
970	1.261
975	1.267
1.052	1.367
1.057	1.374
1.134	1.475
1.141	1.482
1.254	1.630
1.261	1.639
1.267	1.647
1.384	1.800
1.398	1.817

L W	H H	CODICE CODE
--------	--------	----------------

Prezzo Price

46,3	35	IRASSE01P
------	----	-----------

63

IDROBOX BASI
IDROBOX BASE UNITS

IDROBOX COLONNE E PENSILI
IDROBOX TALL AND WALL UNITS

IDROBOX ATTREZZATURA
IDROBOX EQUIPMENT

IDROBOX TOP E LAVATOI
IDROBOX TOPS AND WASHBASINS

INGRESSI
HALLWAY CABINETS

SCARPIERE
SHOE CABINETS

ACCESSORI
ACCESSORIES

PIANI INTEGRATI p. 60 cm - vasca grande

Built-in tops d 60 cm - large basin

MARMO MINERALE

Mineral marble

vasca singola CENTRALE CENTRAL single basin

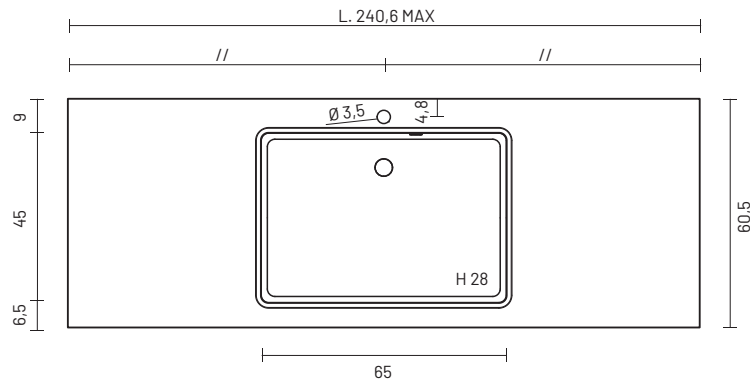
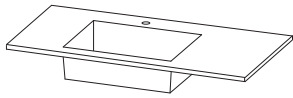

L W	SP TH	P D	CODICE CODE
--------	----------	--------	----------------

Bianco White	Colore Color
-----------------	-----------------

75	1,2	60	U647A8B06
90	1,2	60	U647A8C06
105	1,2	60	U647A8D06
120	1,2	60	U647A8E06
135	1,2	60	U647A8F06
150	1,2	60	U647A8G06
165	1,2	60	U647A8H06
180	1,2	60	U647A8I06
195	1,2	60	U647A8L06
210	1,2	60	U647A8M06
240	1,2	60	U647A8N06

1.071	1.393
1.076	1.399
1.154	1.498
1.159	1.507
1.237	1.609
1.244	1.616
1.359	1.766
1.366	1.775
1.373	1.785
1.491	1.937
1.506	1.956

vasca singola LATERALE SIDE single basin

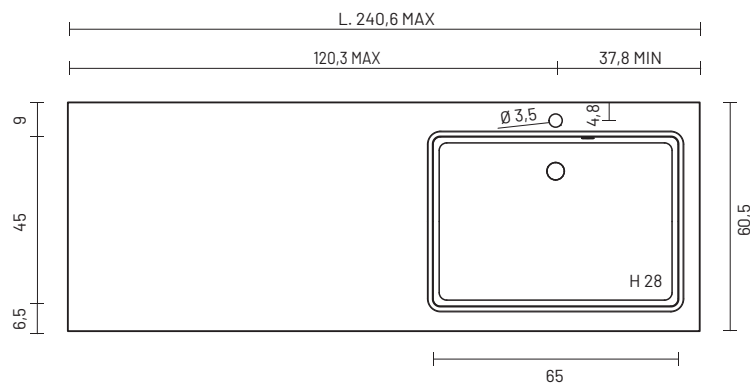
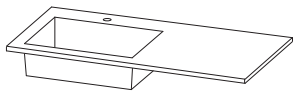

L W	SP TH	P D	CODICE CODE
--------	----------	--------	----------------

Bianco White	Colore Color
-----------------	-----------------

75	1,2	60	U647A9B06
90	1,2	60	U647A9C06
105	1,2	60	U647A9D06
120	1,2	60	U647A9E06
135	1,2	60	U647A9F06
150	1,2	60	U647A9G06
165	1,2	60	U647A9H06
180	1,2	60	U647A9I06
195	1,2	60	U647A9L06
210	1,2	60	U647A9M06
240	1,2	60	U647A9N06

1.071	1.393
1.076	1.399
1.154	1.498
1.159	1.507
1.237	1.609
1.244	1.616
1.359	1.766
1.366	1.775
1.373	1.785
1.491	1.937
1.506	1.956

asse in pino pine wood washing board

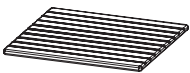

L W	H H	CODICE CODE
--------	--------	----------------

Prezzo Price

63,3	40	IRASSE14
------	----	----------

63

Base lavabo minima L 75 cm.
Specificare sempre asse scarico e asse rubinetto (qualora diversi).
Foro rubinetto incluso di serie.
Piletta di scarico esclusa (pagina 140).

Washbasin unit minimum W 75 cm.
 Always specify the drain and tap axes (if different).
 Tap hole included.
 Drain plug excluded (page 140).

PIANI INTEGRATI p. 60 cm - vasca con scalino

Built-in tops d 60 cm - basin with step

MARMO MINERALE

Mineral marble

vasca singola CENTRALE

CENTRAL single basin

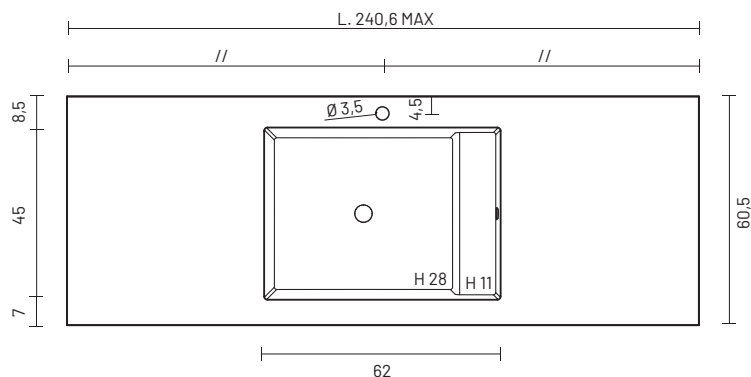
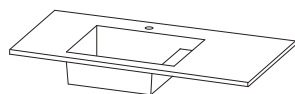

vasca singola LATERALE

SIDE single basin

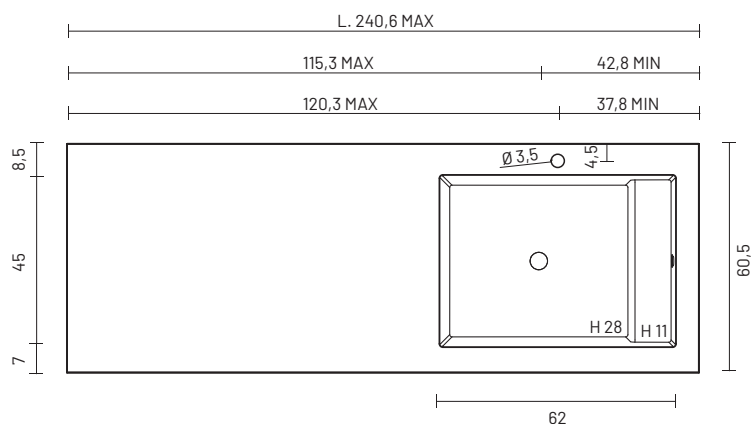
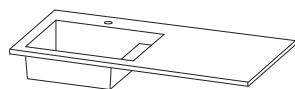

asse in marmo minerale

mineral marble washing board



L W	SP TH	P D	CODICE CODE
--------	----------	--------	----------------

Bianco White	Colore Color
-----------------	-----------------

75	1,2	60	U647B1B06
90	1,2	60	U647B1C06
105	1,2	60	U647B1D06
120	1,2	60	U647B1E06
135	1,2	60	U647B1F06
150	1,2	60	U647B1G06
165	1,2	60	U647B1H06
180	1,2	60	U647B1I06
195	1,2	60	U647B1L06
210	1,2	60	U647B1M06
240	1,2	60	U647B1N06

867	1.116
871	1.123
928	1.196
988	1.274
1.060	1.367
1.100	1.420
1.172	1.514
1.212	1.564
1.290	1.667
1.335	1.725
1.451	1.875

L W	SP TH	P D	CODICE CODE
--------	----------	--------	----------------

Bianco White	Colore Color
-----------------	-----------------

75	1,2	60	U647B2B06
90	1,2	60	U647B2C06
105	1,2	60	U647B2D06
120	1,2	60	U647B2E06
135	1,2	60	U647B2F06
150	1,2	60	U647B2G06
165	1,2	60	U647B2H06
180	1,2	60	U647B2I06
195	1,2	60	U647B2L06
210	1,2	60	U647B2M06
240	1,2	60	U647B2N06

921	1.186
925	1.192
985	1.271
1.048	1.352
1.125	1.450
1.166	1.505
1.244	1.604
1.284	1.657
1.367	1.766
1.413	1.827
1.544	1.995

L W	H H	CODICE CODE
--------	--------	----------------

Bianco White	Colore Color
-----------------	-----------------

48,6	42,6	IRASSE15
------	------	----------

186	283
-----	-----

Base lavabo minima L 75 cm.

Specificare sempre asse scarico e asse rubinetto (qualora diversi).

Foro rubinetto incluso di serie.

Piletta di scarico esclusa (pagina 140).

Washbasin unit minimum W 75 cm.

Always specify the drain and tap axes (if different).

Tap hole included.

Drain plug excluded (page 140).

IDROBOX BASI
IDROBOX BASE UNITS

IDROBOX COLONNE E PENSILI
IDROBOX TALL AND WALL UNITS

IDROBOX ATTREZZATURA
IDROBOX EQUIPMENT

IDROBOX TOP E LAVATOI
IDROBOX TOPS AND WASHBASINS

INGRESSI
HALLWAY CABINETS

SCARPIERE
SHOE CABINETS

ACCESSORI
ACCESSORIES

PIANI INTEGRATI p. 70 cm - vasca piccola

Built-in tops d 70 cm - small basin

MARMO MINERALE

Mineral marble

vasca singola CENTRALE

CENTRAL single basin

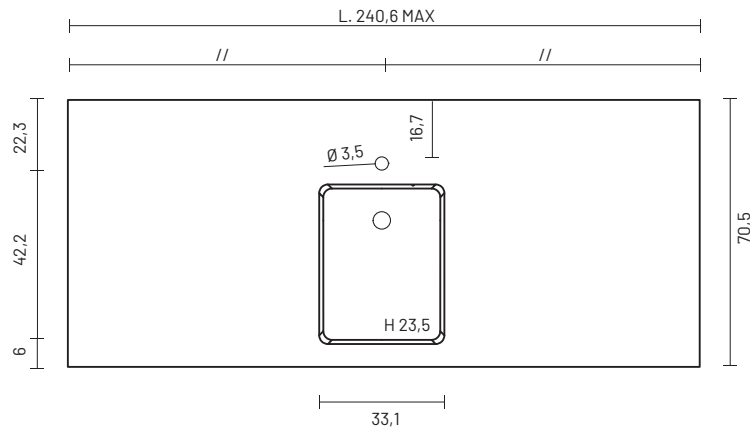
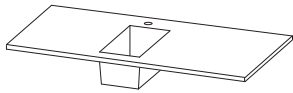

L W	SP TH	P D	CODICE CODE
--------	----------	--------	----------------

Bianco White	Colore Color
-----------------	-----------------

60	1,2	70	U647A4A07
75	1,2	70	U647A4B07
90	1,2	70	U647A4C07
105	1,2	70	U647A4D07
120	1,2	70	U647A4E07
135	1,2	70	U647A4F07
150	1,2	70	U647A4G07
165	1,2	70	U647A4H07
180	1,2	70	U647A4I07
195	1,2	70	U647A4L07
210	1,2	70	U647A4M07
240	1,2	70	U647A4N07

778	1.011
782	1.017
819	1.063
859	1.117
925	1.201
967	1.257
1.037	1.347
1.075	1.397
1.142	1.484
1.186	1.542
1.260	1.637
1.366	1.775

vasca singola LATERALE

SIDE single basin

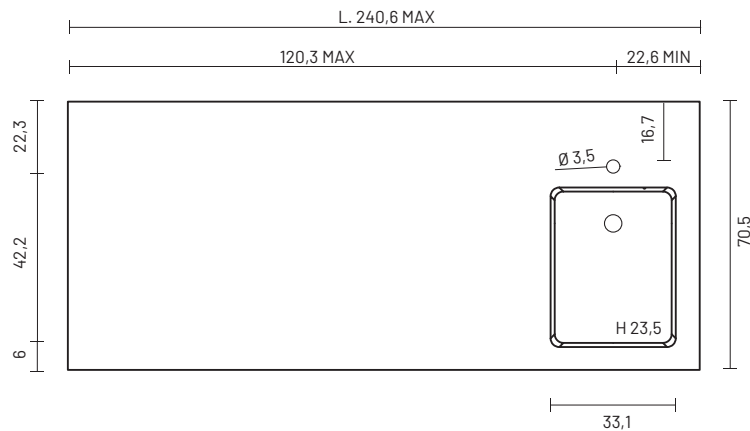
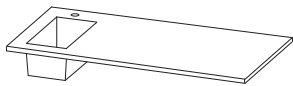

L W	SP TH	P D	CODICE CODE
--------	----------	--------	----------------

Bianco White	Colore Color
-----------------	-----------------

60	1,2	70	U647A5A07
75	1,2	70	U647A5B07
90	1,2	70	U647A5C07
105	1,2	70	U647A5D07
120	1,2	70	U647A5E07
135	1,2	70	U647A5F07
150	1,2	70	U647A5G07
165	1,2	70	U647A5H07
180	1,2	70	U647A5I07
195	1,2	70	U647A5L07
210	1,2	70	U647A5M07
240	1,2	70	U647A5N07

831	1.079
836	1.086
873	1.136
917	1.193
987	1.281
1.031	1.340
1.105	1.437
1.146	1.490
1.217	1.582
1.263	1.642
1.341	1.743
1.462	1.900

asse in pino

pine wood washing board

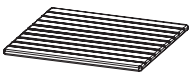

L W	H H	CODICE CODE
--------	--------	----------------

Prezzo Price

31,3	35	IRASSE00P
------	----	-----------

63

Specificare sempre asse scarico e asse rubinetto (qualora diversi).
Foro rubinetto incluso di serie.
Piletta di scarico esclusa (pagina 140).

Always specify the drain and tap axes (if different).
 Tap hole included.
 Drain plug excluded (page 140).

PIANI INTEGRATI p. 70 cm

Built-in tops d 70 cm

MARMO MINERALE

Mineral marble

vasca singola CENTRALE

CENTRAL single basin

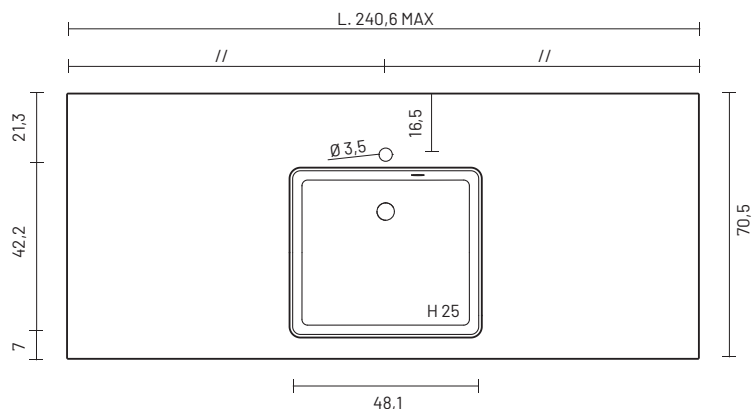
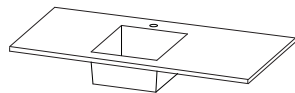

vasca singola LATERALE

SIDE single basin

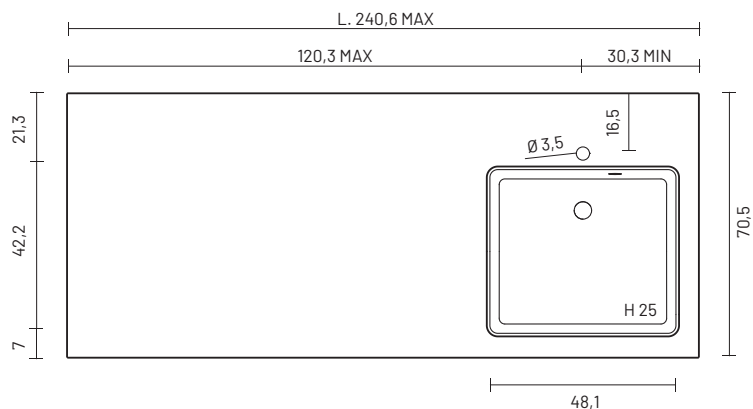
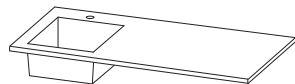

asse in pino

pine wood washing board

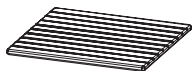

Specificare sempre asse scarico e asse rubinetto (qualora diversi).
Foro rubinetto incluso di serie.
Piletta di scarico esclusa (pagina 140).

Always specify the drain and tap axes (if different).
 Tap hole included.
 Drain plug excluded (page 140).

L W	SP TH	P D	CODICE CODE
--------	----------	--------	----------------

Bianco White	Colore Color
-----------------	-----------------

60	1,2	70	U647A6A07
75	1,2	70	U647A6B07
90	1,2	70	U647A6C07
105	1,2	70	U647A6D07
120	1,2	70	U647A6E07
135	1,2	70	U647A6F07
150	1,2	70	U647A6G07
165	1,2	70	U647A6H07
180	1,2	70	U647A6I07
195	1,2	70	U647A6L07
210	1,2	70	U647A6M07
240	1,2	70	U647A6N07

969	1.260
975	1.267
981	1.275
1.057	1.374
1.062	1.381
1.141	1.482
1.146	1.490
1.261	1.639
1.267	1.647
1.274	1.656
1.398	1.817
1.406	1.827

L W	SP TH	P D	CODICE CODE
--------	----------	--------	----------------

Bianco White	Colore Color
-----------------	-----------------

60	1,2	70	U647A7A07
75	1,2	70	U647A7B07
90	1,2	70	U647A7C07
105	1,2	70	U647A7D07
120	1,2	70	U647A7E07
135	1,2	70	U647A7F07
150	1,2	70	U647A7G07
165	1,2	70	U647A7H07
180	1,2	70	U647A7I07
195	1,2	70	U647A7L07
210	1,2	70	U647A7M07
240	1,2	70	U647A7N07

969	1.260
975	1.267
981	1.275
1.057	1.374
1.062	1.381
1.141	1.482
1.146	1.490
1.261	1.639
1.267	1.647
1.274	1.656
1.398	1.817
1.406	1.827

L W	H H	CODICE CODE
--------	--------	----------------

Prezzo Price

46,3	35	IRASSE01P
------	----	-----------

63

IDROBOX BASI
IDROBOX BASE UNITS

IDROBOX COLONNE E PENSILI
IDROBOX TALL AND WALL UNITS

IDROBOX ATTREZZATURA
IDROBOX EQUIPMENT

IDROBOX TOP E LAVATOI
IDROBOX TOPS AND WASHBASINS

INGRESSI
HALLWAY CABINETS

SCARPIERE
SHOE CABINETS

ACCESSORI
ACCESSORIES

PIANI INTEGRATI p. 70 cm - vasca grande

Built-in tops th 1,2 cm d 70 - large basin

MARMO MINERALE

Mineral marble

vasca singola CENTRALE

CENTRAL single basin

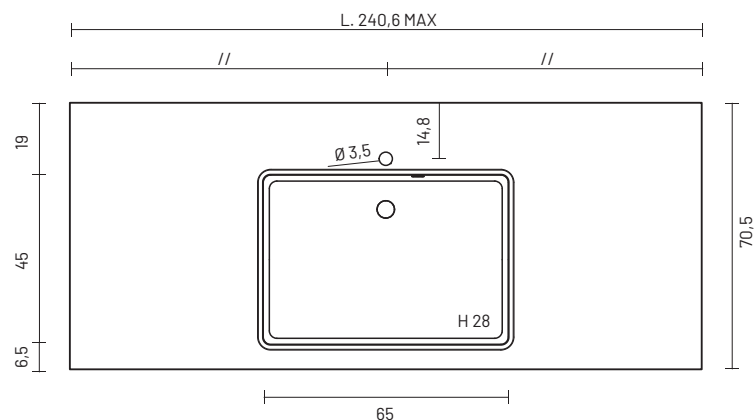
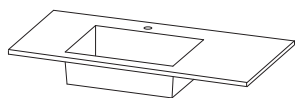

L W	SP TH	P D	CODICE CODE
--------	----------	--------	----------------

Bianco White	Colore Color
-----------------	-----------------

75	1,2	70	U647A8B07
90	1,2	70	U647A8C07
105	1,2	70	U647A8D07
120	1,2	70	U647A8E07
135	1,2	70	U647A8F07
150	1,2	70	U647A8G07
165	1,2	70	U647A8H07
180	1,2	70	U647A8I07
195	1,2	70	U647A8L07
210	1,2	70	U647A8M07
240	1,2	70	U647A8N07

1.015	1.318
1.020	1.326
1.092	1.421
1.099	1.428
1.173	1.524
1.179	1.533
1.289	1.674
1.295	1.684
1.303	1.694
1.414	1.838
1.422	1.848

vasca singola LATERALE

SIDE single basin

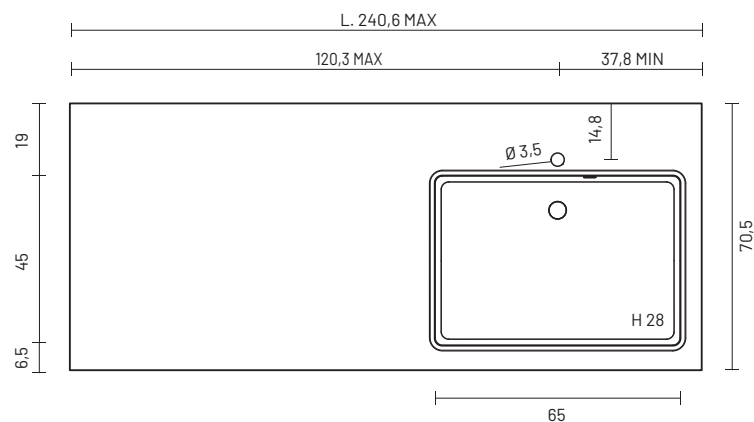
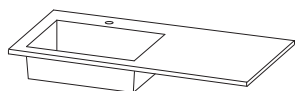

L W	SP TH	P D	CODICE CODE
--------	----------	--------	----------------

Bianco White	Colore Color
-----------------	-----------------

75	1,2	70	U647A9B07
90	1,2	70	U647A9C07
105	1,2	70	U647A9D07
120	1,2	70	U647A9E07
135	1,2	70	U647A9F07
150	1,2	70	U647A9G07
165	1,2	70	U647A9H07
180	1,2	70	U647A9I07
195	1,2	70	U647A9L07
210	1,2	70	U647A9M07
240	1,2	70	U647A9N07

1.076	1.399
1.083	1.407
1.159	1.507
1.165	1.515
1.244	1.616
1.250	1.625
1.366	1.775
1.373	1.785
1.380	1.793
1.506	1.956
1.512	1.966

asse in pino

pine wood washing board



L W	H H	CODICE CODE
--------	--------	----------------

Prezzo Price

63,3	40	IRASSE14
------	----	----------

63

Base lavabo minima L 75 cm.
Specificare sempre asse scarico e asse rubinetto (qualora diversi).
Foro rubinetto incluso di serie.
Piletta di scarico esclusa (pagina 140).

Washbasin unit minimum W 75 cm.
 Always specify the drain and tap axes (if different).
 Tap hole included.
 Drain plug excluded (page 140).

PIANI INTEGRATI p. 70 cm - vasca con scalino

Built-in tops th 1,2 cm d 70 - basin with step

MARMO MINERALE

Mineral marble

vasca singola CENTRALE

CENTRAL single basin

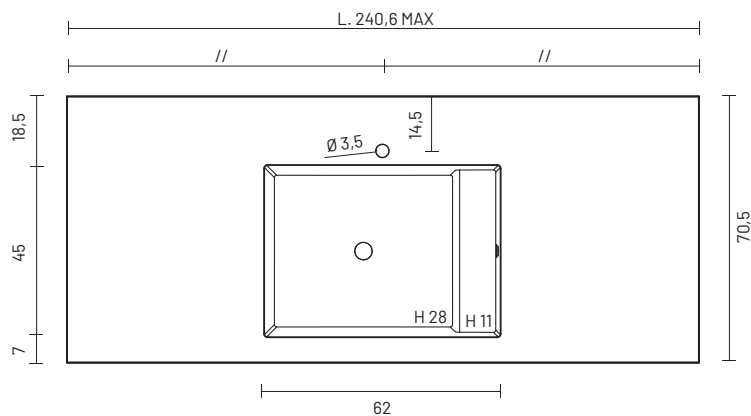
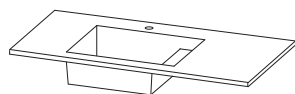

vasca singola LATERALE

SIDE single basin

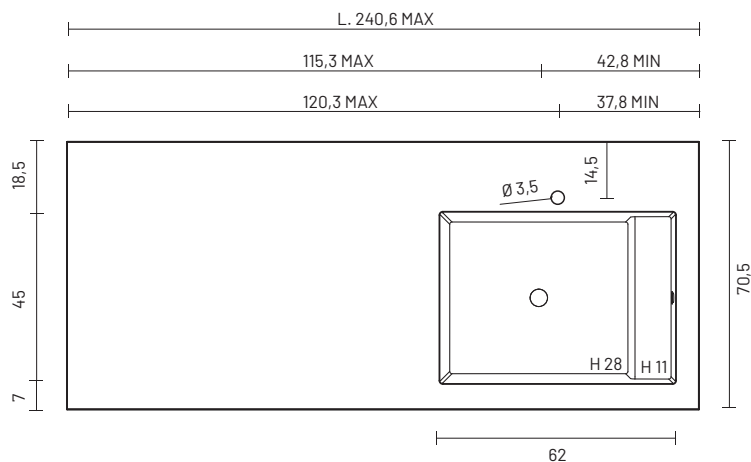
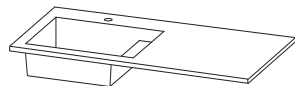

asse in marmo minerale

mineral marble washing board

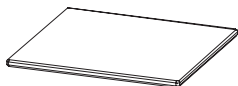

Base lavabo minima L 75 cm.

Specificare sempre asse scarico e asse rubinetto (qualora diversi).

Foro rubinetto incluso di serie.

Piletta di scarico esclusa (pagina 140).

Washbasin unit minimum W 75 cm.

Always specify the drain and tap axes (if different).

Tap hole included.

Drain plug excluded (page 140).

L W	SP TH	P D	CODICE CODE
--------	----------	--------	----------------

Bianco White	Colore Color
-----------------	-----------------

75	1,2	70	U647B1B07
90	1,2	70	U647B1C07
105	1,2	70	U647B1D07
120	1,2	70	U647B1E07
135	1,2	70	U647B1F07
150	1,2	70	U647B1G07
165	1,2	70	U647B1H07
180	1,2	70	U647B1I07
195	1,2	70	U647B1L07
210	1,2	70	U647B1M07
240	1,2	70	U647B1N07

871	1.123
875	1.129
933	1.203
994	1.280
1.066	1.374
1.105	1.427
1.179	1.522
1.218	1.572
1.296	1.676
1.342	1.734
1.458	1.885

L W	SP TH	P D	CODICE CODE
--------	----------	--------	----------------

Bianco White	Colore Color
-----------------	-----------------

75	1,2	70	U647B2B07
90	1,2	70	U647B2C07
105	1,2	70	U647B2D07
120	1,2	70	U647B2E07
135	1,2	70	U647B2F07
150	1,2	70	U647B2G07
165	1,2	70	U647B2H07
180	1,2	70	U647B2I07
195	1,2	70	U647B2L07
210	1,2	70	U647B2M07
240	1,2	70	U647B2N07

925	1.192
930	1.198
990	1.276
1.055	1.359
1.130	1.457
1.172	1.512
1.249	1.613
1.290	1.666
1.374	1.775
1.428	1.845
1.551	2.005

L W	H H	CODICE CODE
--------	--------	----------------

Bianco White	Colore Color
-----------------	-----------------

48,6	42,6	IRASSE15
------	------	----------

186	283
-----	-----

IDROBOX BASI
IDROBOX BASE UNITS

IDROBOX COLONNE E PENSILI
IDROBOX TALL AND WALL UNITS

IDROBOX ATTREZZATURA
IDROBOX EQUIPMENT

IDROBOX TOP E LAVATOI
IDROBOX TOPS AND WASHBASINS

INGRESSI
HALLWAY CABINETS

SCARPIERE
SHOE CABINETS

ACCESSORI
ACCESSORIES

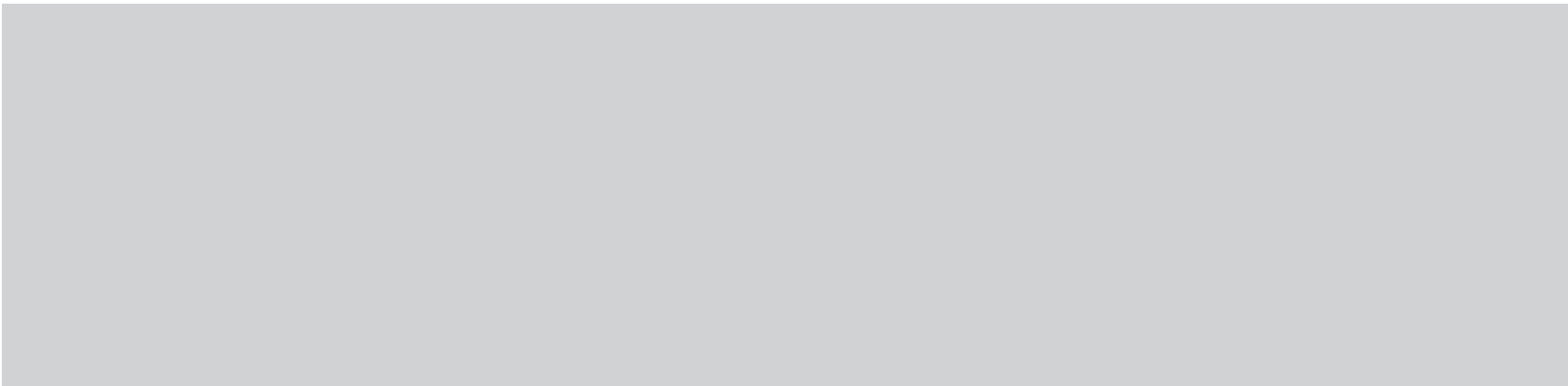

LAVATOI E MISCELATORI

Washbasins and mixer taps

ACCESSORI
ACCESSORIES

SCARPIERE
SHOE CABINETS

INGRESSI
HALLWAY CABINETS

IDROBOX TOP E LAVATOI
IDROBOX TOPS AND WASHBASINS

IDROBOX ATTREZZATURA
IDROBOX EQUIPMENT

IDROBOX COLONNE E PENSILI
IDROBOX TALL AND WALL UNITS

IDROBOX BASI
IDROBOX BASE UNITS

LAVATOI IN METACRILATO INCASSO SOPRAPIANO

Over-counter built-in methacrylate washbasins

lavatoio
washbasin

pietta e sifone inclusi
disponibile solo per piani P 60-70 cm
drain plug and siphon included
available only for D 60-70 cm top

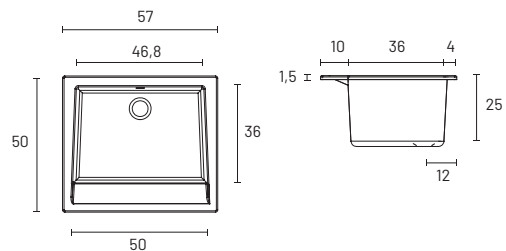
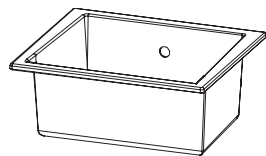

L W	H H	P D	CODICE CODE	Prezzo Price
--------	--------	--------	----------------	-----------------

57	25	50	U84010	215
----	----	----	--------	-----

asse in pino
pine wood washing board

51,2	39,2		IRASSE10P	76
------	------	--	-----------	----

Non disponibile per incasso su piani in marmo minerale.

Not available for recessed on mineral marble countertops.

LAVATOI IN MARMO MINERALE INCASSO SOPRAPIANO

Mineral marble over-counter built-in washbasins

lavatoio L 60 P 50 cm

washbasin W 60 D 50 cm

finitura bianco lucido, foro rubinetto di serie
glossy white finish, standard mixer hole

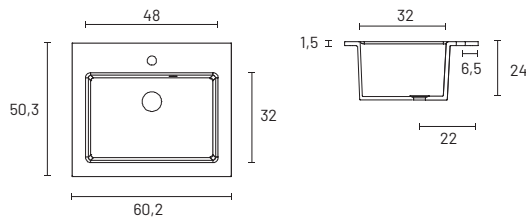
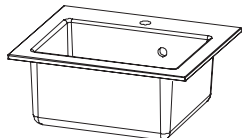

asse in pino
pine wood washing board

L W	H H	P D	CODICE CODE	Prezzo Price
60,2	24	50,3	U85010	605
46,3	35		IRASSE01P	63

lavatoio L 45 P 60 cm

washbasin W 45 D 60 cm

finitura bianco lucido, foro rubinetto di serie
disponibile solo per piani P 70 cm, non utilizzabile su basi lavabo ad angolo
glossy white finish, standard mixer hole
available only for D 70 cm top, not usable on corner washbasin units

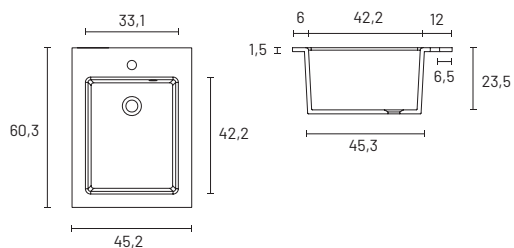
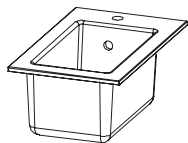

asse in pino
pine wood washing board

L W	H H	P D	CODICE CODE	Prezzo Price
45,2	23,5	60,3	U85000	605
31,3	35		IRASSE00P	63

lavatoio L 60 P 60 cm

washbasin W 60 D 60 cm

finitura bianco lucido, foro rubinetto di serie
disponibile sono per piani P 60-70 cm, non utilizzabile su basi lavabo ad angolo
glossy white finish, standard mixer hole
available only for D 60-70 cm top, not usable on corner washbasin units

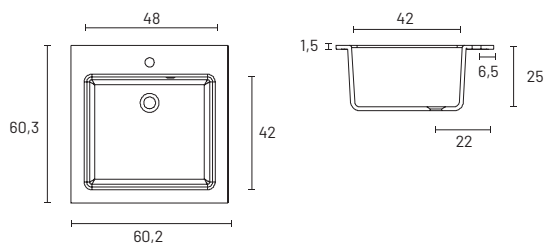
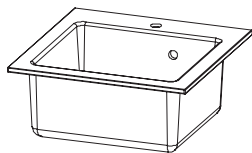

asse in pino
pine wood washing board

L W	H H	P D	CODICE CODE	Prezzo Price
60,2	24	50,3	U85020	630
46,3	35		IRASSE01P	63

Non disponibile per incasso su piani in marmo minerale.

Not available for recessed on mineral marble countertops.

IDROBOX BASI
IDROBOX BASE UNITS

IDROBOX COLONNE E PENSILI
IDROBOX TALL AND WALL UNITS

IDROBOX ATTREZZATURA
IDROBOX EQUIPMENT

IDROBOX TOP E LAVATOI
IDROBOX TOPS AND WASHBASINS

INGRESSI
HALLWAY CABINETS

SCARPIERE
SHOE CABINETS

ACCESSORI
ACCESSORIES

LAVATOI IN CERAMICA INCASSO SOPRAPIANO

Ceramic over-counter built-in washbasins

lavatoio L 61 P 51 cm

washbasin W 61 D 51 cm

finitura bianco lucido, foro rubinetto di serie

disponibile sono per piani P 60-70 cm, non utilizzabile su basi lavabo ad angolo

glossy white finish, standard mixer hole

available only for D 60-70 cm top, not usable on corner washbasin units

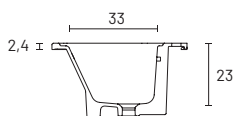
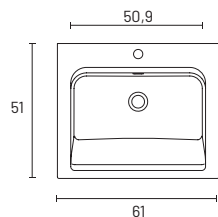

asse in pino

pine wood washing board

L W	H H	P D	CODICE CODE	Prezzo Price
61	23	51	U85530	530
48,5	38,3		IRASSE06P	63

lavatoio L 71 P 51 cm

washbasin W 71 D 51 cm

finitura bianco lucido, foro rubinetto di serie

disponibile sono per piani P 60-70 cm, non utilizzabile su basi lavabo ad angolo

glossy white finish, standard mixer hole

available only for D 60-70 cm top, not usable on corner washbasin units

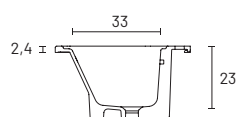
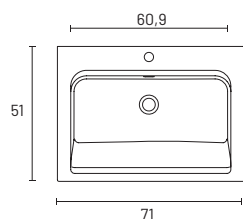

asse in pino

pine wood washing board

L W	H H	P D	CODICE CODE	Prezzo Price
71	23	51	U85540	587
58,5	38,3		IRASSE21P	76

LAVATOIO IN CERAMICA

Ceramic washbasin

lavatoio MEG
MEG washbasin

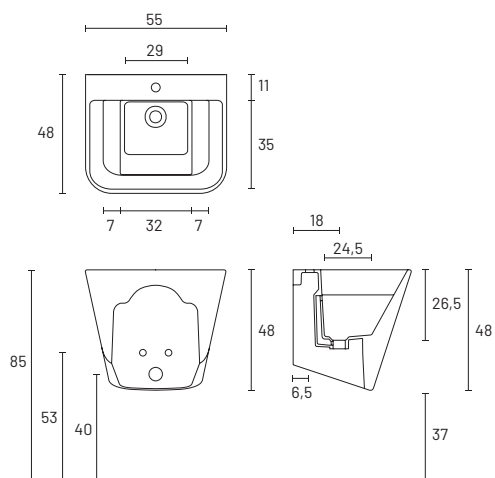
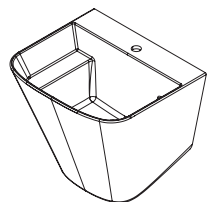

asse in legno
wooden washing board

L W	H H	P D	CODICE CODE	Prezzo Price
55	48	35	U85550	583
46,5	29,3		IRASSE11	119

ACCESSORI
ACCESSORIES

SCARPIERE
SHOE CABINETS

INGRESSI
HALLWAY CABINETS

IDROBOX TOP E LAVATOI
IDROBOX TOPS AND WASHBASINS

IDROBOX ATTREZZATURA
IDROBOX EQUIPMENT

IDROBOX COLONNE E PENSILI
IDROBOX TALL AND WALL UNITS

IDROBOX BASI
IDROBOX BASE UNITS

PILETTE DI SCARICO

Drain plugs

UP-DOWN



Finitura Finish	CODICE CODE	Prezzo Price
cromo chrome	U502001C	58
ceramica ceramic	U502001A	90
mineral 5 colori mineral 5 colours	U502001M	141

LIBERO



Finitura Finish	CODICE CODE	Prezzo Price
cromo chrome	U502002C	56
ceramica ceramic	U502002A	76
mineral 5 colori mineral 5 colours	U502002M	112

ATTENZIONE: nei piani integrati con copripiletta in tinta inclusa, la ghiera superiore della piletta va rimossa al momento dell'installazione per permettere il corretto posizionamento del copripiletta.

NOTE: for integrated tops with a matching drain cover included, the upper drain ring must be removed during installation so the drain cover can be correctly positioned.

SIFONI

siphons

1" 1/4 BOTTIGLIA



Finitura Finish	CODICE CODE	Prezzo Price
--------------------	----------------	-----------------

cromo chrome	U512001	65
------------------------	---------	-----------

sifone passepartout flessibile lucido

glossy flexible universal siphon



Finitura Finish	CODICE CODE	Prezzo Price
--------------------	----------------	-----------------

cromo chrome	U512003	56
------------------------	---------	-----------

sifone salvaspazio in plastica

space-saving plastic siphon



Finitura Finish	CODICE CODE	Prezzo Price
--------------------	----------------	-----------------

bianco white	U512005	30
------------------------	---------	-----------

IDROBOX BASI
IDROBOX BASE UNITS

IDROBOX COLONNE E PENSILI
IDROBOX TALL AND WALL UNITS

IDROBOX ATTREZZATURA
IDROBOX EQUIPMENT

IDROBOX TOP E LAVATOI
IDROBOX TOPS AND WASHBASINS

INGRESSI
HALLWAY CABINETS

SCARPIERE
SHOE CABINETS

ACCESSORI
ACCESSORIES

MISCELATORI

Mixer taps

miscelatore lavabo BIBO

BIBO washbasin mixer tap

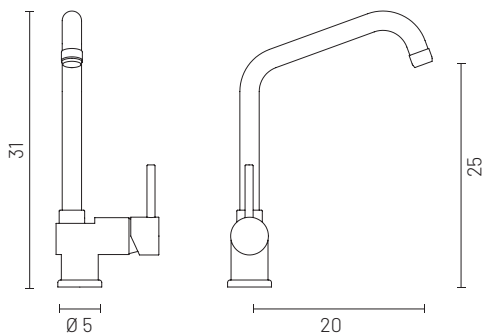

Finitura Finish	CODICE CODE	Prezzo Price
--------------------	----------------	-----------------

cromo chrome	8838030	185
-----------------	---------	-----

miscelatore lavabo con doccetta estraibile BIBO

BIBO washbasin mixer tap with extractable hand shower

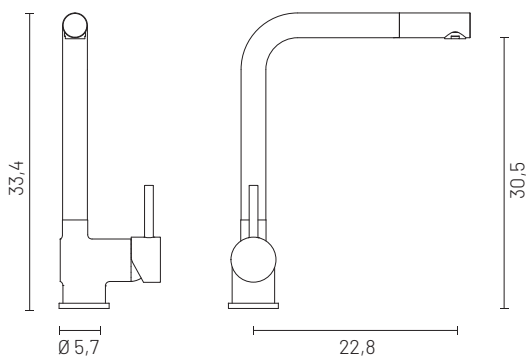

Finitura Finish	CODICE CODE	Prezzo Price
--------------------	----------------	-----------------

cromo chrome	8840020	286
-----------------	---------	-----

miscelatore lavabo con doccetta estraibile MICRO

MICRO washbasin mixer tap with extractable hand shower

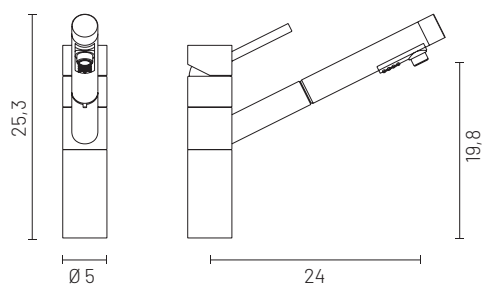

Finitura Finish	CODICE CODE	Prezzo Price
--------------------	----------------	-----------------

cromo chrome	8896020	442
-----------------	---------	-----

INGRESSI

Hallway cabinets

GOLA UP	P. 145
• BASI Base units	P. 155
• PENSILI Wall units	P. 161
• COLONNE Tall units	P. 175
• ACCESSORI Accessories	P. 189
• ILLUMINAZIONE Lighting	P. 190
• TOP Tops	P. 192
SKAP	P. 193
• ARMADIO BATTENTE Hinged door wardrobe	P. 198
• ARMADIO SCORREVOLE Sliding door wardrobe	P. 200

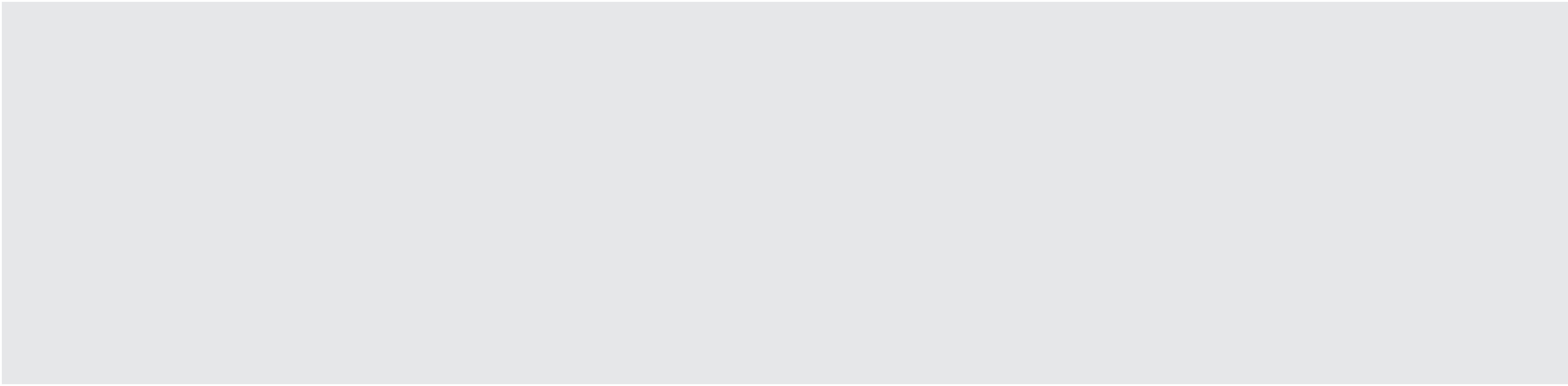

GOLA UP

ACCESSORI
ACCESSORIES

SCARPIERE
SHOE CABINETS

INGRESSI
HALLWAY CABINETS

IDROBOX TOP E LAVATOI
IDROBOX TOPS AND WASHBASINS

IDROBOX ATTREZZATURA
IDROBOX EQUIPMENT





IDROBOX COLONNE E PENSILI
IDROBOX TALL AND WALL UNITS

IDROBOX BASI
IDROBOX BASE UNITS

LACCATI OPACHI E LUCIDI | MATT AND GLOSSY LACQUERS

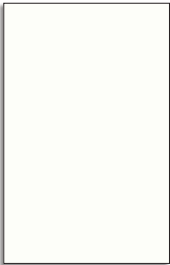
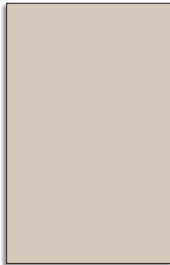
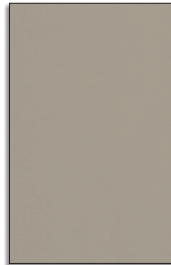
							
9003 Bianco	9010 Panna	9001 Crema	1013 Fior di loto	9002 Ghiaccio	100 Sabbia	63 Tortora	68 Grigio perla
							
71 Light grey	7044 Grigio seta	62 Canapa	61 Corda	72 Dark grey	7039 Grigio aston	101 Giallo senape	173 Bruciato
							
3003 Rosso	3005 Rosso bordeaux	102 Rosa cipria	74 Terracotta	73 Moka	190 Verde pallido	103 Verde malva	104 Turchese
							
105 Oceano	106 Blu cobalto	246 Grigio Garda	107 Celeste	76 Carta da zucchero	7031 Grigio blu	7016 Grigio antracite	9017 Nero
							
Titanio	Nichel	Piombo					

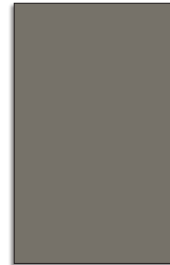
MATERICI | TEXTURED FINISHES

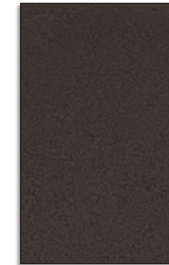
							
Bianco	Sabbia	Avana	Alpaca	Quarzo	Perla	Argilla	Lava

			
Rovere virginia Virginia oak	Noce california California walnut	Noce alabama Alabama walnut	Rovere termotrattato Heat-treated oak

La riproduzione dei colori su carta può risultare alterata rispetto agli originali, pertanto queste tinte sono da considerarsi indicative. Laccato a campione/RAL con maggiorazione del 20%.

The reproduction of the colours on paper may be different compared to the original ones, therefore these shades should be considered as representative only. 20% surcharge for custom colour/RALs.

SUPERFICI UP | UP SURFACE

Laccati metallici | Metal effect lacquers



Titanio

Piombo

Nichel

Ossido ottone

Ossido bronzo

Laccati effetto cemento | Concrete effect lacquers

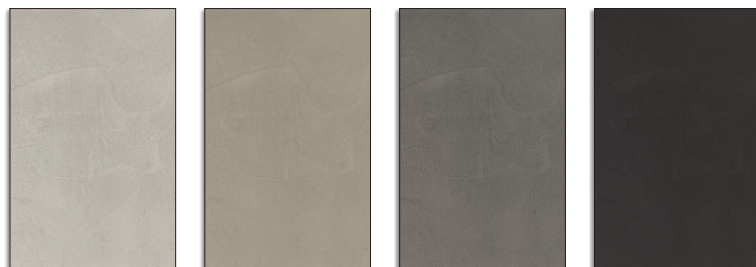

Perla

Argilla

Grafite

Lava

ESSENZE | WOOD



Rovere naturale
Natural oak

Rovere visone
Visone oak

Rovere cenere
Cenere oak

Rovere castoro
Castoro oak

Rovere carbone
Carbone oak

Noce canaletto
Canaletto walnut

Rovere termotrattato
Heat-treated oak

VETRI TRASPARENTI E SPECCHI | TRANSPARENT GLASSES AND MIRROR



Trasparente grigio
Transparent Grey

Trasparente bronzo
Transparent Bronze

Specchio
Mirror

METALLI | METALS

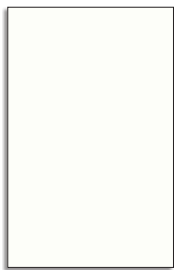

Bianco
White

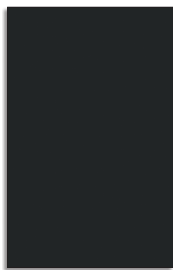

Nero
Black



Titanio
Titanium

GRES | STONEWARE **disponibile solo per top** | available only for tops

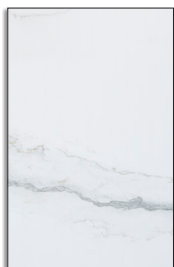

Larsen bianco



Pacific bianco



Jasper moka



Iseo grigio



Storm grigio

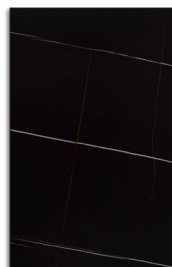

Azalai nero



Silver root

CARATTERISTICHE TECNICHE

Technical features

GOLA UP

SCOCHE in pannelli di particelle di legno certificati CARB-2 sp. 18 mm e schiene sp. 8 mm
STRUCTURES made with CARB-2-certified 18 mm thick particleboard panels and 8 mm thick backs

ATTACCAGLIE regolabili con sistema antisganciamento
adjustable FASTENERS with mechanism to prevent accidental release

CERNIERE in acciaio brunito con chiusura ammortizzata integrata a scomparsa Salice
Salice HINGES with built-in concealed soft-close mechanism

GUIDE ad estrazione totale Hettich con chiusura ammortizzata
Hettich RUNNERS with full pull-out and soft close

RIPIANI INTERNI in pannelli di particelle di legno certificati CARB-2 sp. 18 mm
INTERNAL SHELVES made with CARB-2-certified 18 mm thick particleboard panels

SPONDE Hettich metalliche verniciate antracite
Metal Hettich SIDEBARDS painted in Antracite

FRONTALI in pannelli di particelle di legno certificati CARB-2 sp. 22 mm
FRONTS made with 22 mm th CARB-2-certified particleboard panels

MANIGLIA in alluminio finitura metallo
aluminium HANDLE in in metal finish

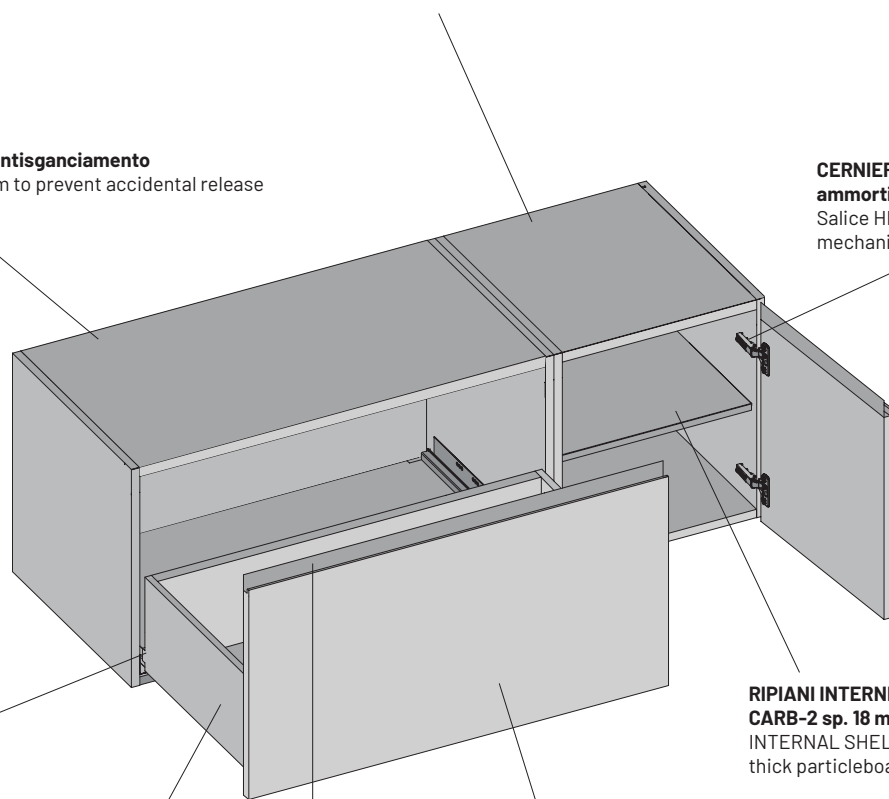

IDROBOX BASI
IDROBOX BASE UNITS

IDROBOX COLONNE E PENSILI
IDROBOX TALL AND WALL UNITS

IDROBOX ATTREZZATURA
IDROBOX EQUIPMENT

IDROBOX TOP E LAVATOI
IDROBOX TOPS AND WASHBASINS

INGRESSI
HALLWAY CABINETS

SCARPIERE
SHOE CABINETS

ACCESSORI
ACCESSORIES

SCOCCHE STRUCTURES

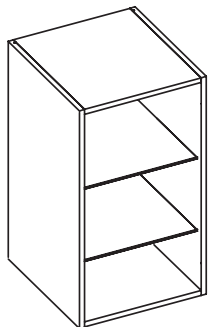

FIANCHI, COPERCHIO E FONDO: pannelli di particelle di legno certificati CARB-02 sp. 18 mm rivestiti con nobilitazione melaminica, laccati o impiallacciati legno e verniciati; bordatura poliuretanica idrorepellente.

SCHIENE: pannelli di particelle di legno certificati CARB-02 sp. 8 mm con nobilitazione melaminica.

SIDES, TOP AND BOTTOM: CARB-02-certified 18 mm thick particleboard panels which have a melamine coating, are lacquered or have a painted wood veneer; water-repellent polyurethane edging.

BACKS: CARB-02-certified 8 mm thick particleboard panels with melamine coating.

FINITURA ESTERNA EXTERNAL FINISH	FINITURA SCOCCA BASI BASE UNIT STRUCTURE FINISH	FINITURA SCOCCA PENSILI E COLONNE WALL AND TALL UNIT STRUCTURE FINISH
MATERICO TEXTURED FINISH	<ul style="list-style-type: none"> • Coperchio, fondo, schiena: materico avana (due lati) Fianchi: materico come il frontale (due lati) • Top, bottom, back: Avana textured finish (two sides) Sides: textured finish like the front (two sides) 	<ul style="list-style-type: none"> • Schiena: materico avana Coperchio, fondo, fianchi: materico come il frontale (due lati) • Back: Avana textured finish Top, bottom, sides: textured finish textured finish like the front (two sides)
LACCATO/ESSENZA LACQUER/WOOD	<ul style="list-style-type: none"> • Coperchio, fondo, schiena: materico avana (due lati) Fianchi: lato interno materico avana, lato esterno come il frontale • Top, bottom, back: Avana textured finish (two sides) Sides: internal side in Avana textured finish, external side in finish like the front 	<ul style="list-style-type: none"> • Schiena: materico avana Coperchio, fondo, fianchi: lato interno materico avana, lato esterno come il frontale • Back: Avana textured finish Top, bottom, sides: internal side in Avana textured finish, external side in finish like the front

FRONTALI FRONTS



FRONTALI: pannelli di particelle di legno certificati CARB-02 sp. 22 mm rivestiti con nobilitazione melaminica, laccati o impiallacciati legno e verniciati; bordatura poliuretanica idrorepellente. Senso vena orizzontale nelle basi, verticale in colonne e pensili.

FRONTALI TELAIO: telaio in alluminio sezione 40x20 mm (nelle finiture bianco, nero e titanio) con vetro temperato sp. 4 mm trasparente bronzo o grigio, oppure specchio sp. 3 mm.

MANIGLIA: in alluminio disponibile nelle finiture bianco, nero e titanio. Disposta orizzontalmente in basi e pensili, in verticale nelle colonne. La maniglia può essere intera o parziale rispetto alla lunghezza (o altezza nel caso delle colonne) del frontale. Nei frontali telaio la maniglia è in alluminio nella stessa finitura del telaio.

FRONTS: CARB-02-certified 22 mm thick particleboard panels which have a melamine coating, are lacquered or have a painted wood veneer; water-repellent polyurethane edging. Horizontal grain direction on the base units, vertical on the tall and wall units.

FRAMED FRONTS: 40x20 mm section aluminium frame (in white, black and titanium) with 4 mm thick clear bronze or grey tempered glass or 3 mm thick mirror.

HANDLE: aluminium handle available in white, black and titanium. Horizontal for base and wall units and vertical for tall units. The handle can be the full width of the front (or height in the case of tall units) or partial. On the frame fronts the handle is made of aluminium in the same finish as the frame.

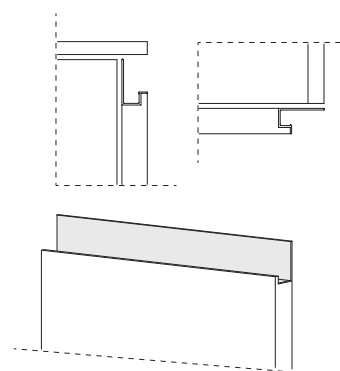

Maggiorazione per scocca interna nelle finiture laccato opaco: + 20%.
Maggiorazione per maniglia nelle finiture laccato opaco: + € 38.

Surcharge for internal structure in matt lacquered finish: + 20%.
Surcharge for handle in matt lacquered finishes: + € 38.

CARATTERISTICHE TECNICHE

Technical features

GOLA UP

MANIGLIA PARZIALE PARTIAL HANDLE



La maniglia può essere intera o parziale rispetto alla lunghezza (o altezza nel caso delle colonne) del frontale.

The handle can be the full width of the front (or height in the case of tall units) or partial.

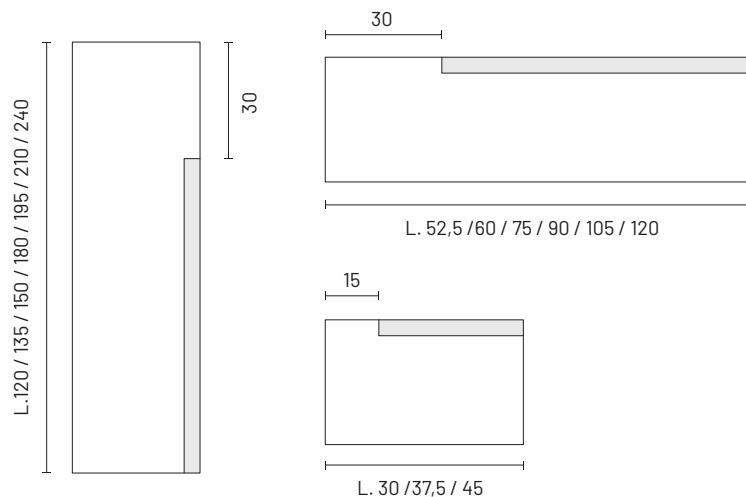

RIPIANI INTERNI INTERNAL SHELVES



RIPIANI IN LEGNO: pannelli di particelle di legno certificati CARB-02 sp. 18 mm rivestiti con nobilitazione melaminica avana; bordatura poliuretanicica idrorepellente.

RIPIANI IN CRISTALLO: sp. 6 mm con reggripiano con blocco, finitura trasparente grigio. Solo per pensili e colonne con frontale telaio

WOODEN SHELVES: CARB-02-certified 18 mm thick particleboard panels with Avana melamine coating; water-repellent polyurethane edging.

GLASS SHELVES: 6 mm thick with locking brackets, grey transparent finish. Only for wall and tall units with framed fronts.

SPONDE E GUIDE PER CASSETTI/CASSETTONI

SIDEBOARDS AND RUNNERS FOR STANDARD/DEEP DRAWERS

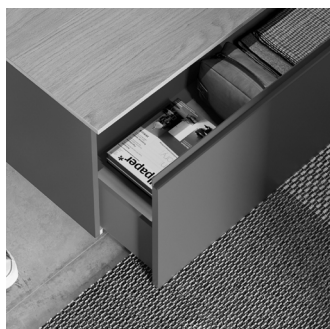

SPONDE AVANTECH: Hettich mod. AvanTech YOU caratterizzato da sottili sponde metalliche verniciate antracite, fondi e retri in pannelli di particelle di legno certificati CARB-02 sp. 16 mm con nobilitazione melaminica. Con la possibilità di inserimento di luce nella parte superiore della sponda.

H sponde cassetto: 10,1 cm
H sponde cassettoni: 18,8 cm

GUIDE: metalliche sincronizzate a scomparsa con estrazione totale, regolazioni invisibili e sistema di chiusura ammortizzata.

AVANTECH SIDEBOARDS Hettich AvanTech YOU consisting of slim, anthracite-painted metal sideboards; bottoms and backs made of CARB-02-certified 16 mm thick particleboard panels with a melamine finish. A light can be added at the top of the sideboard.

H sideboards for drawers: 10,1 cm
H sideboards for deep drawers: 18,8 cm

RUNNERS: synchronised, concealed, full pull-out metal runners with invisible adjustment mechanism and soft close.

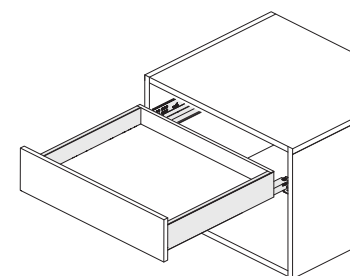

IDROBOX BASI
IDROBOX BASE UNITS

IDROBOX COLONNE E PENSILI
IDROBOX TALL AND WALL UNITS

IDROBOX ATTREZZATURA
IDROBOX EQUIPMENT

IDROBOX TOP E LAVATOI
IDROBOX TOPS AND WASHBASINS

INGRESSI
HALLWAY CABINETS

SCARPIERE
SHOE CABINETS

ACCESSORI
ACCESSORIES

CARATTERISTICHE TECNICHE

Technical features

GOLA UP

ZOCCOLO E PIEDI

PLINTH AND FEET



ZOCCOLO: H 6 cm, in finitura alluminio, nero, bianco oppure nelle colorazioni laccato opaco. Fissaggio mediante aggancio magnetico.

PIEDI: H 1,5 cm regolabili a scomparsa in finitura alluminio.

PLINTH: h 6 cm, in aluminium, black, white or colored matt lacquered finishes. Secured by magnetic attachment.

FEET: concealed, adjustable h 1,5 cm in aluminium finish.

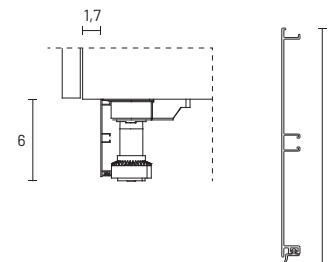

ATTACCAGLIE

FASTENERS



Tutte le attaccaglie sono regolabili e hanno un sistema antiganciamento.

Le basi hanno attaccaglie interne alla scocca con carter di copertura su apertura battente. Gli altri elementi hanno attaccaglie a scomparsa sempre dotate di copriforo in finitura zama o laccata in tinta su vani a giorno.

Non sono inclusi viti e tasselli per il fissaggio a muro.

All the fasteners are adjustable and have a mechanism to prevent accidental release.

Base units have fasteners inside the structure with a cover for the hinged opening. The other units have concealed fasteners with hole covers in a Zamak or matching lacquered finish on open compartments.

Screws and dowels for wall mounting are not included.

BASI BASE UNITS

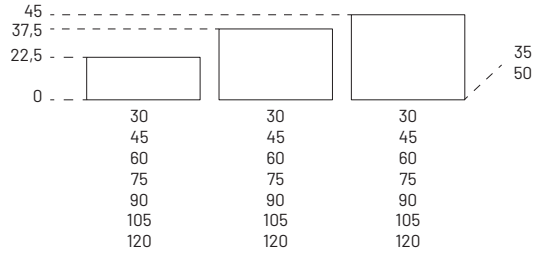

PENSILI WALL UNITS

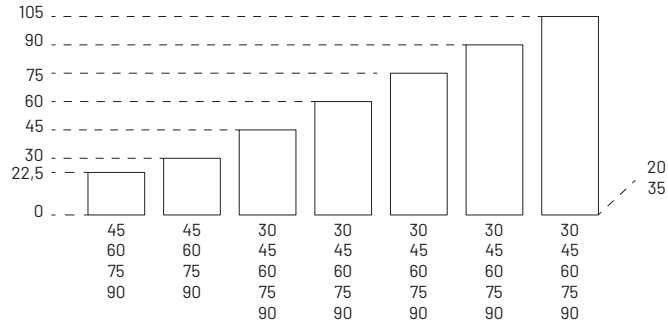

COLONNE TALL UNITS

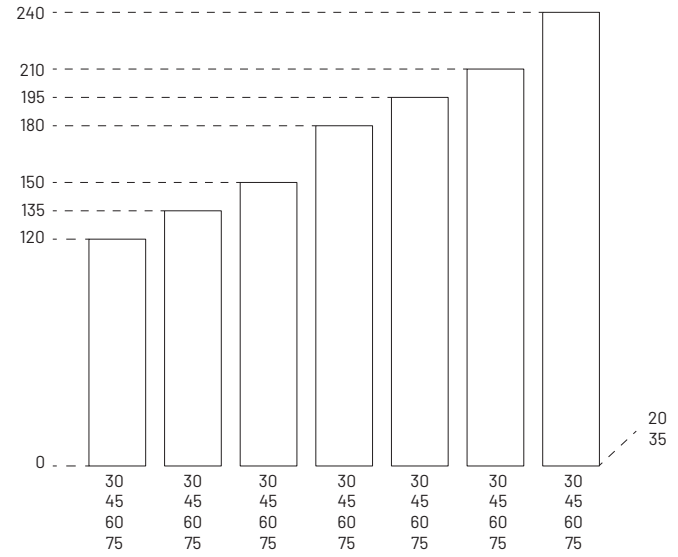

MAGGIORAZIONI PER FUORI MISURA

Surcharges for oversized measurements

GOLA UP

INDICAZIONI GENERALI

GENERAL INFORMATION

Le maggiorazioni per interventi fuori misura dovranno essere applicate sull'elemento di serie con caratteristiche similari e/o misure superiori all'elemento.

È possibile realizzare personalizzazioni fuori misura su elementi con anta/e battente o cassetti/cestoni ma per quest'ultimi va sempre verificata la fattibilità con l'ufficio tecnico.

Quando vengono richiesti più interventi fuori misura sullo stesso elemento, la maggiorazione da applicare è data dalla somma dei singoli interventi.

Per interventi fuori misura particolari, non contemplati in queste pagine, si dovrà richiedere la conferma di fattibilità e conseguente preventivo.

Non si accettano resi di elementi modificati fuori misura.

Surcharges for oversized products must be applied to the standard unit with similar characteristics and/or a larger size.

Oversized customisation is possible on units with hinged door(s) or drawers but please always check feasibility with the technical department for drawers specifically.

When multiple oversized measurement requests are made for the same unit, the surcharge to be applied is the sum of the individual requests.

For special oversized measurements not covered here, please request confirmation of feasibility and a quote.

We do not accept returns of modified oversized units.

RIDUZIONE IN LARGHEZZA

WIDTH REDUCTION

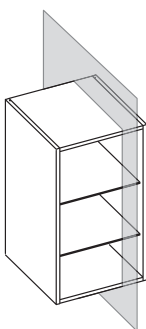

	CODICE CODE	Prezzo Price
basi ante battenti hinged door base units	MGB0020	216
basi cassetto base units with drawer	MGBC0020	304
pensili wall units	MGP0020	216
colonne ante battenti hinged door tall units	MGC0020	304

RIDUZIONE IN ALTEZZA

HEIGHT REDUCTION

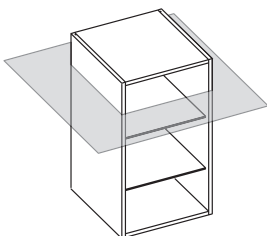

	CODICE CODE	Prezzo Price
basi ante battenti hinged door base units	MGB0040	216
basi cassetto base units with drawer	MGBC0040	304
pensili wall units	MGP0040	216
colonne ante battenti hinged door tall units	MGC0040	216

RIDUZIONE IN PROFONDITÀ

DEPTH REDUCTION

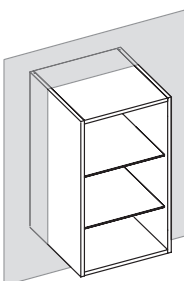

	CODICE CODE	Prezzo Price
basi ante battenti hinged door base units	MGB0060	216
basi cassetto base units with drawer	MGBC0060	216
pensili wall units	MGP0060	216
colonne ante battenti hinged door tall units	MGC0060	304

BASI H 22,5 cm

Base units h 22,5 cm

GOLA UP

1 anta ribalta

1 tilt door

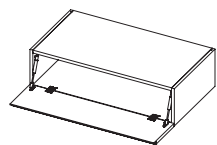

	L W	H H	P D	CODICE CODE	Materico Textured finish	Lacc. opaco Matt lacq.	Lacc. lucido Glossy lacq.	Essenza Wood	Superfici UP UP surface
P 35	45	22,5	35	DGBN6122	318	353	380	421	401
	60	22,5	35	DGBN6132	342	382	412	455	432
	75	22,5	35	DGBN6142	382	426	462	509	483
	90	22,5	35	DGBN6152	420	469	512	564	534
	105	22,5	35	DGBN6162	458	513	563	619	584
	120	22,5	35	DGBN6172	498	558	613	674	636
P 50	45	22,5	50	DGBN6124	343	385	416	457	432
	60	22,5	50	DGBN6134	369	415	450	493	467
	75	22,5	50	DGBN6144	411	463	502	550	520
	90	22,5	50	DGBN6154	452	510	553	607	573
	105	22,5	50	DGBN6164	494	558	605	665	626
	120	22,5	50	DGBN6174	536	605	656	722	679

1 cassetto

1 drawer

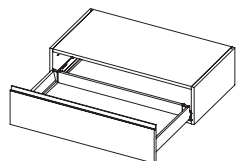

	L W	H H	P D	CODICE CODE	Materico Textured finish	Lacc. opaco Matt lacq.	Lacc. lucido Glossy lacq.	Essenza Wood	Superfici UP UP surface
P 35	30	22,5	35	DGBN1112	346	373	401	431	409
	45	22,5	35	DGBN1122	370	400	430	465	440
	60	22,5	35	DGBN1132	391	430	465	512	474
	75	22,5	35	DGBN1142	428	471	512	561	522
	90	22,5	35	DGBN1152	465	512	558	610	571
	105	22,5	35	DGBN1162	502	553	604	658	619
120	22,5	35	DGBN1172	538	594	651	707	668	
P 50	30	22,5	50	DGBN1114	373	405	438	464	450
	45	22,5	50	DGBN1124	399	436	470	501	483
	60	22,5	50	DGBN1134	422	469	508	551	521
	75	22,5	50	DGBN1144	461	513	555	606	571
	90	22,5	50	DGBN1154	499	558	603	661	620
	105	22,5	50	DGBN1164	538	602	651	717	670
120	22,5	50	DGBN1174	577	646	698	771	720	

Indicare in fase d'ordine se inserire la maniglia intera o parziale (dx o sx).
Aggiungere sempre il top (pagina 192).

Indicate full or partial handle (R or L) when ordering.
Always add the top (page 192).

IDROBOX BASI
IDROBOX BASE UNITS

IDROBOX COLONNE E PENSILI
IDROBOX TALL AND WALL UNITS

IDROBOX ATTREZZATURA
IDROBOX EQUIPMENT

IDROBOX TOP E LAVATOI
IDROBOX TOPS AND WASHBASINS

INGRESSI
HALLWAY CABINETS

SCARPIERE
SHOE CABINETS

ACCESSORI
ACCESSORIES

BASI H 37,5 cm

Base units h 37,5 cm

GOLA UP

1 anta ribalta

1 tilt door

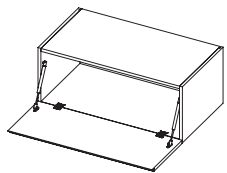

L W	H H	P D	CODICE CODE
--------	--------	--------	----------------

Materico Textured finish	Lacc. opaco Matt lacq.	Lacc. lucido Glossy lacq.	Essenza Wood	Superfici UP UP surface
-----------------------------	---------------------------	------------------------------	-----------------	----------------------------

P 35	L W	H H	P D	CODICE CODE
	45	37,5	35	DGBN6222
	60	37,5	35	DGBN6232
	75	37,5	35	DGBN6242
	90	37,5	35	DGBN6252
	105	37,5	35	DGBN6262
	120	37,5	35	DGBN6272

358	397	428	474	450
385	428	462	510	486
428	478	519	573	544
472	529	576	634	601
516	577	633	696	658
560	627	691	758	714

P 50	L W	H H	P D	CODICE CODE
	45	37,5	50	DGBN6224
	60	37,5	50	DGBN6234
	75	37,5	50	DGBN6244
	90	37,5	50	DGBN6254
	105	37,5	50	DGBN6264
	120	37,5	50	DGBN6274

385	432	469	513	486
414	467	506	555	525
461	520	564	619	586
508	574	623	683	645
557	627	681	748	705
603	681	739	812	764

1 cassettone

1 deep drawer

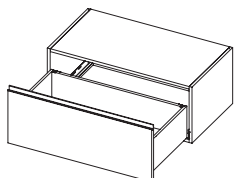

L W	H H	P D	CODICE CODE
--------	--------	--------	----------------

Materico Textured finish	Lacc. opaco Matt lacq.	Lacc. lucido Glossy lacq.	Essenza Wood	Superfici UP UP surface
-----------------------------	---------------------------	------------------------------	-----------------	----------------------------

P 35	L W	H H	P D	CODICE CODE
	30	37,5	35	DGBN3212
	45	37,5	35	DGBN3222
	60	37,5	35	DGBN3232
	75	37,5	35	DGBN3242
	90	37,5	35	DGBN3252
	105	37,5	35	DGBN3262
	120	37,5	35	DGBN3272

390	421	452	486	462
417	451	485	524	495
442	485	524	577	534
483	532	576	632	589
524	577	629	687	644
565	624	681	741	697
606	670	734	796	752

P 50	L W	H H	P D	CODICE CODE
	30	37,5	50	DGBN3214
	45	37,5	50	DGBN3224
	60	37,5	50	DGBN3234
	75	37,5	50	DGBN3244
	90	37,5	50	DGBN3254
	105	37,5	50	DGBN3264
	120	37,5	50	DGBN3274

420	457	493	521	506
448	491	530	562	544
475	529	572	620	587
519	578	625	682	642
562	627	679	744	698
605	678	733	806	753
650	727	785	868	809

Indicare in fase d'ordine se inserire la maniglia intera o parziale (dx o sx).
Aggiungere sempre il top (pagina 192).

Indicate full or partial handle (R or L) when ordering.
Always add the top (page 192).

BASI A TERRA H 37,5 cm

Floor-standing base units h 37,5 cm

GOLA UP

1 anta ribalta

1 tilt door

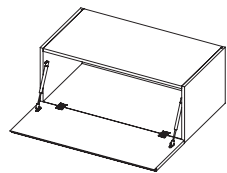

	L W	H H	P D	CODICE CODE	Materico Textured finish	Lacc. opaco Matt lacq.	Lacc. lucido Glossy lacq.	Essenza Wood	Superfici UP UP surface
P 35	45	37,5	35	DGBT6222	375	416	449	496	472
	60	37,5	35	DGBT6232	403	449	485	536	510
	75	37,5	35	DGBT6242	449	502	545	602	571
	90	37,5	35	DGBT6252	495	555	605	666	631
P 50	45	37,5	50	DGBT6224	403	455	492	538	510
	60	37,5	50	DGBT6234	435	491	532	583	552
	75	37,5	50	DGBT6244	484	546	592	651	615
	90	37,5	50	DGBT6254	534	603	654	718	678

1 cassettone

1 deep drawer

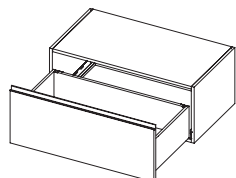

	L W	H H	P D	CODICE CODE	Materico Textured finish	Lacc. opaco Matt lacq.	Lacc. lucido Glossy lacq.	Essenza Wood	Superfici UP UP surface
P 35	45	37,5	35	DGBT3222	438	474	509	550	520
	60	37,5	35	DGBT3232	464	509	550	606	561
	75	37,5	35	DGBT3242	507	559	605	664	618
	90	37,5	35	DGBT3252	550	606	660	721	677
P 50	45	37,5	50	DGBT3224	470	516	557	590	571
	60	37,5	50	DGBT3234	498	555	600	652	616
	75	37,5	50	DGBT3244	545	607	656	717	675
	90	37,5	50	DGBT3254	590	659	712	781	734

Indicare in fase d'ordine se inserire la maniglia intera o parziale (dx o sx).
 Inclusi piedini regolabili a scomparsa H 1,6 cm. Zoccolo optional H 6 cm (pagina 189).
 Compreso di sistema di rinforzo antiflessione.
 Aggiungere sempre il top (pagina 192).

Indicate full or partial handle (R or L) when ordering.
 Hidden adjustable feet H 1,6 cm included. Optional plinth H 6 cm (page 189).
 Anti-flex reinforcement system included.
 Always add the top (page 192).

IDROBOX BASI
IDROBOX BASE UNITS

IDROBOX COLONNE E PENSILI
IDROBOX TALL AND WALL UNITS

IDROBOX ATTREZZATURA
IDROBOX EQUIPMENT

IDROBOX TOP E LAVATOI
IDROBOX TOPS AND WASHBASINS

INGRESSI
HALLWAY CABINETS

SCARPIERE
SHOE CABINETS

ACCESSORI
ACCESSORIES

BASI H 45 cm

Base units h 45 cm

GOLA UP

1 anta ribalta 1 tilt door

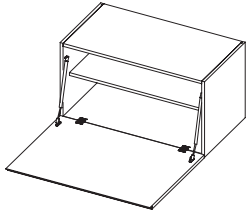

1 ripiano legno 1 wooden shelf

L W	H H	P D	CODICE CODE
--------	--------	--------	----------------

P 35	45	45	35	DGBN6422
	60	45	35	DGBN6432
	75	45	35	DGBN6442
	90	45	35	DGBN6452

P 50	45	45	50	DGBN6424
	60	45	50	DGBN6434
	75	45	50	DGBN6444
	90	45	50	DGBN6454

Materico Textured finish	Lacc. opaco Matt lacq.	Lacc. lucido Glossy lacq.	Essenza Wood	Superfici UP UP surface
-----------------------------	---------------------------	------------------------------	-----------------	----------------------------

394	436	471	521	495
423	471	508	562	535
471	525	571	630	598
519	580	633	697	660

423	476	516	564	535
455	515	557	611	578
506	573	620	681	644
560	631	684	752	709

1 cassettone 1 deep drawer

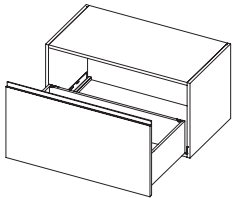

L W	H H	P D	CODICE CODE
--------	--------	--------	----------------

P 35	30	45	35	DGBN3412
	45	45	35	DGBN3422
	60	45	35	DGBN3432
	75	45	35	DGBN3442
	90	45	35	DGBN3452
	105	45	35	DGBN3462
	120	45	35	DGBN3472

P 50	30	45	50	DGBN3414
	45	45	50	DGBN3424
	60	45	50	DGBN3434
	75	45	50	DGBN3444
	90	45	50	DGBN3454
	105	45	50	DGBN3464
	120	45	50	DGBN3474

Materico Textured finish	Lacc. opaco Matt lacq.	Lacc. lucido Glossy lacq.	Essenza Wood	Superfici UP UP surface
-----------------------------	---------------------------	------------------------------	-----------------	----------------------------

418	463	518	573	524
445	496	555	616	562
469	534	601	679	606
509	587	660	746	673
551	639	720	813	740
592	692	779	881	808
634	744	839	947	875

452	515	574	630	590
481	551	615	678	632
508	591	663	747	682
553	651	726	825	752
598	709	792	903	823
644	768	857	983	895
688	827	923	1.061	967

Indicare in fase d'ordine se inserire la maniglia intera o parziale (dx o sx).
Aggiungere sempre il top (pagina 192).

Indicate full or partial handle (R or L) when ordering.
Always add the top (page 192).

BASI H 45 cm

Base units h 45 cm

GOLA UP

2 cassetti H 22,1

2 drawers H 22,1

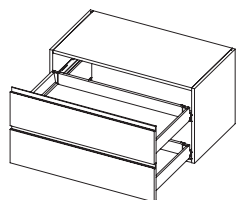

L W	H H	P D	CODICE CODE
--------	--------	--------	----------------

P 35	L W	H H	P D	CODICE CODE
	30	45	35	DGBN2412
	45	45	35	DGBN2422
	60	45	35	DGBN2432
	75	45	35	DGBN2442
	90	45	35	DGBN2452
	105	45	35	DGBN2462
	120	45	35	DGBN2472

P 50	L W	H H	P D	CODICE CODE
	30	45	50	DGBN2414
	45	45	50	DGBN2424
	60	45	50	DGBN2434
	75	45	50	DGBN2444
	90	45	50	DGBN2454
	105	45	50	DGBN2464
	120	45	50	DGBN2474

Materico Textured finish	Lacc. opaco Matt lacq.	Lacc. lucido Glossy lacq.	Essenza Wood	Superfici UP UP surface
-----------------------------	---------------------------	------------------------------	-----------------	----------------------------

532	575	632	707	633
566	619	679	763	680
597	667	737	842	736
653	735	813	928	820
708	804	888	1.015	904
763	872	965	1.101	990
817	940	1.041	1.187	1.075

560	623	680	740	704
598	670	732	800	755
633	722	790	885	816
692	796	871	982	904
750	871	952	1.078	994
808	947	1.032	1.176	1.083
867	1.021	1.114	1.273	1.171

Indicare in fase d'ordine se inserire la maniglia intera o parziale (dx o sx).
Aggiungere sempre il top (pagina 192).

Indicate full or partial handle (R or L) when ordering.
Always add the top (page 192).

IDROBOX BASI
IDROBOX BASE UNITS

IDROBOX COLONNE E PENSILI
IDROBOX TALL AND WALL UNITS

IDROBOX ATTREZZATURA
IDROBOX EQUIPMENT

IDROBOX TOP E LAVATOI
IDROBOX TOPS AND WASHBASINS

INGRESSI
HALLWAY CABINETS

SCARPIERE
SHOE CABINETS

ACCESSORI
ACCESSORIES

BASI A TERRA H 45 cm

Floor-standing base units h 45 cm

GOLA UP

1 cassettone

1 deep drawer

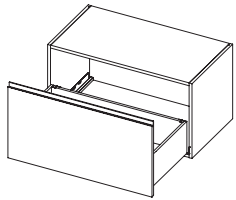

L W	H H	P D	CODICE CODE
--------	--------	--------	----------------

Materico Textured finish	Lacc. opaco Matt lacq.	Lacc. lucido Glossy lacq.	Essenza Wood	Superfici UP UP surface
-----------------------------	---------------------------	------------------------------	-----------------	----------------------------

P 35	45	45	35	DGBT3422
	60	45	35	DGBT3432
	75	45	35	DGBT3442
	90	45	35	DGBT3452

467	521	583	646	590
492	561	631	712	637
535	616	693	782	707
579	670	755	854	778

P 50	45	45	50	DGBT3424
	60	45	50	DGBT3434
	75	45	50	DGBT3444
	90	45	50	DGBT3454

506	579	645	711	664
534	620	695	783	717
582	683	763	866	790
629	744	831	950	864

Indicare in fase d'ordine se inserire la maniglia intera o parziale (dx o sx).
 Inclusi piedini regolabili a scomparsa H 1,6 cm. Zoccolo optional H 6 cm (pagina 189).
 Compreso di sistema di rinforzo antiflessione.
 Aggiungere sempre il top (pagina 192).

Indicate full or partial handle (R or L) when ordering.
 Hidden adjustable feet H 1,6 cm included. Optional plinth H 6 cm (page 189).
 Anti-flex reinforcement system included.
 Always add the top (page 192).

PENSILI H 22,5 cm

Wall units h 22,5 cm

GOLA UP

1 anta ribalta

1 lift-up door

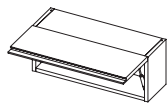

L W	H H	P D	CODICE CODE
--------	--------	--------	----------------

Materico Textured finish	Lacc. opaco Matt lacq.	Lacc. lucido Glossy lacq.	Essenza Wood	Superfici UP UP surface
-----------------------------	---------------------------	------------------------------	-----------------	----------------------------

P 20	45	22,5	20	DGPS6121
	60	22,5	20	DGPS6131
	75	22,5	20	DGPS6141
	90	22,5	20	DGPS6151

308	373	426	491	448
332	405	465	538	490
357	438	504	587	531
393	483	555	645	583

P 35	45	22,5	35	DGPS6122
	60	22,5	35	DGPS6132
	75	22,5	35	DGPS6142
	90	22,5	35	DGPS6152

369	448	509	589	537
399	486	558	646	587
428	525	605	704	637
471	578	666	773	699

Indicare in fase d'ordine se inserire la maniglia intera o parziale (dx o sx).

Indicate full or partial handle (R or L) when ordering.

IDROBOX BASI
IDROBOX BASE UNITS

IDROBOX COLONNE E PENSILI
IDROBOX TALL AND WALL UNITS

IDROBOX ATTREZZATURA
IDROBOX EQUIPMENT

IDROBOX TOP E LAVATOI
IDROBOX TOPS AND WASHBASINS

INGRESSI
HALLWAY CABINETS

SCARPIERE
SHOE CABINETS

ACCESSORI
ACCESSORIES

PENSILI H 30 cm

Wall units h 30 cm

GOLA UP

1 anta ribalta

1 lift-up door

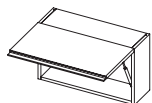

L W	H H	P D	CODICE CODE
--------	--------	--------	----------------

P 20	45	30	20	DGPS6221
	60	30	20	DGPS6231
	75	30	20	DGPS6241
	90	30	20	DGPS6251

P 35	45	30	35	DGPS6222
	60	30	35	DGPS6232
	75	30	35	DGPS6242
	90	30	35	DGPS6252

Materico Textured finish	Lacc. opaco Matt lacq.	Lacc. lucido Glossy lacq.	Essenza Wood	Superfici UP UP surface
-----------------------------	---------------------------	------------------------------	-----------------	----------------------------

332	402	459	530	484
359	438	502	582	529
386	474	545	633	573
425	521	600	696	630

398	483	550	636	580
430	525	602	697	634
463	567	653	759	687
508	625	719	835	755

1 anta ribalta telaio

1 lift-up framed door

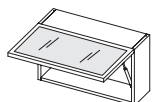

L W	H H	P D	CODICE CODE
--------	--------	--------	----------------

P 20	45	30	20	DGPT6221
	60	30	20	DGPT6231
	75	30	20	DGPT6241
	90	30	20	DGPT6251

Materico Textured finish	Lacc. opaco Matt lacq.	Lacc. lucido Glossy lacq.	Essenza Wood	Superfici UP UP surface
-----------------------------	---------------------------	------------------------------	-----------------	----------------------------

413	443	474	504	480
452	486	519	552	525
494	533	571	609	578
536	580	620	665	631

Indicare in fase d'ordine se inserire la maniglia intera o parziale (dx o sx).

Indicate full or partial handle (R or L) when ordering.

PENSILI H 45 cm

Wall units h 45 cm

GOLA UP

1 anta ribalta

1 lift-up door

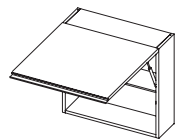

1 ripiano legno

1 wooden shelf

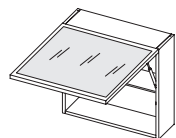

1 anta ribalta telaio

1 lift-up framed door

1 ripiano cristallo

1 glass shelf

L W	H H	P D	CODICE CODE
--------	--------	--------	----------------

P 20	L W	H H	P D	CODICE CODE
	45	45	20	DGPS6421
	60	45	20	DGPS6431
	75	45	20	DGPS6441
	90	45	20	DGPS6451

P 35	L W	H H	P D	CODICE CODE
	45	45	35	DGPS6422
	60	45	35	DGPS6432
	75	45	35	DGPS6442
	90	45	35	DGPS6452

Materico Textured finish	Lacc. opaco Matt lacq.	Lacc. lucido Glossy lacq.	Essenza Wood	Superfici UP UP surface
-----------------------------	---------------------------	------------------------------	-----------------	----------------------------

408	494	564	652	594
441	538	617	714	650
474	583	669	778	705
521	640	736	856	775

490	593	678	781	713
530	646	740	857	779
567	698	804	934	845
625	768	884	1.028	929

L W	H H	P D	CODICE CODE
--------	--------	--------	----------------

P 20	L W	H H	P D	CODICE CODE
	45	45	20	DGPT6421
	60	45	20	DGPT6431
	75	45	20	DGPT6441
	90	45	20	DGPT6451

Materico Textured finish	Lacc. opaco Matt lacq.	Lacc. lucido Glossy lacq.	Essenza Wood	Superfici UP UP surface
-----------------------------	---------------------------	------------------------------	-----------------	----------------------------

508	546	583	619	591
557	597	639	680	647
607	655	700	749	711
660	713	764	817	776

Indicare in fase d'ordine se inserire la maniglia intera o parziale (dx o sx).

Indicate full or partial handle (R or L) when ordering.

IDROBOX BASI
IDROBOX BASE UNITS

IDROBOX COLONNE E PENSILI
IDROBOX TALL AND WALL UNITS

IDROBOX ATTREZZATURA
IDROBOX EQUIPMENT

IDROBOX TOP E LAVATOI
IDROBOX TOPS AND WASHBASINS

INGRESSI
HALLWAY CABINETS

SCARPIERE
SHOE CABINETS

ACCESSORI
ACCESSORIES

PENSILI H 45 cm

Wall units h 45 cm

GOLA UP

1 anta dx o sx

1 R or L door

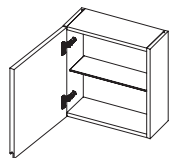

1 ripiano legno

1 wooden shelf

L W	H H	P D	CODICE CODE
--------	--------	--------	----------------

P 20	30	45	20	DGPS8411
	45	45	20	DGPS8421
	60	45	20	DGPS8431

P 35	30	45	35	DGPS8412
	45	45	35	DGPS8422
	60	45	35	DGPS8432

Materico Textured finish	Lacc. opaco Matt lacq.	Lacc. lucido Glossy lacq.	Essenza Wood	Superfici UP UP surface
-----------------------------	---------------------------	------------------------------	-----------------	----------------------------

327	403	472	555	498
355	442	520	615	548
384	481	569	674	600

391	483	565	677	597
426	531	624	750	658
461	577	682	822	719

1 anta telaio dx o sx

1 L or R framed door

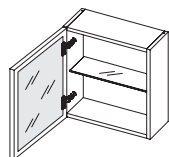

1 ripiano cristallo

1 glass shelf

L W	H H	P D	CODICE CODE
--------	--------	--------	----------------

P 20	30	45	20	DGPT8411
	45	45	20	DGPT8421
	60	45	20	DGPT8431

P 35	30	45	35	DGPT8412
	45	45	35	DGPT8422
	60	45	35	DGPT8432

Materico Textured finish	Lacc. opaco Matt lacq.	Lacc. lucido Glossy lacq.	Essenza Wood	Superfici UP UP surface
-----------------------------	---------------------------	------------------------------	-----------------	----------------------------

467	518	576	656	593
508	559	619	696	634
549	598	661	737	675

561	620	691	787	711
610	669	741	836	761
659	719	793	884	810

Indicare in fase d'ordine se inserire la maniglia intera o parziale (dx o sx).

Indicate full or partial handle (R or L) when ordering.

PENSILI H 45 cm

Wall units h 45 cm

GOLA UP

2 ante

2 doors

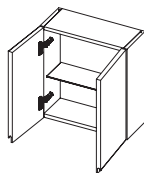

1 ripiano legno
1 wooden shelf

L W	H H	P D	CODICE CODE
--------	--------	--------	----------------

P 20	60	45	20	DGPS9431
	75	45	20	DGPS9441
	90	45	20	DGPS9451

P 35	60	45	35	DGPS9432
	75	45	35	DGPS9442
	90	45	35	DGPS9452

Materico Textured finish	Lacc. opaco Matt lacq.	Lacc. lucido Glossy lacq.	Essenza Wood	Superfici UP UP surface
-----------------------------	---------------------------	------------------------------	-----------------	----------------------------

447	560	638	741	673
479	616	711	835	752
510	671	785	928	833

535	670	765	904	807
575	738	854	1.019	902
613	806	942	1.132	999

2 ante telaio

2 framed doors

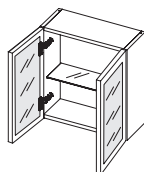

1 ripiano cristallo
1 glass shelf

L W	H H	P D	CODICE CODE
--------	--------	--------	----------------

P 20	60	45	20	DGPT9431
	75	45	20	DGPT9441
	90	45	20	DGPT9451

P 35	60	45	35	DGPT9432
	75	45	35	DGPT9442
	90	45	35	DGPT9452

Materico Textured finish	Lacc. opaco Matt lacq.	Lacc. lucido Glossy lacq.	Essenza Wood	Superfici UP UP surface
-----------------------------	---------------------------	------------------------------	-----------------	----------------------------

598	640	681	722	690
646	693	738	786	749
693	747	796	850	809

677	723	793	863	802
729	783	860	940	872
782	844	927	1.016	942

Indicare in fase d'ordine se inserire la maniglia intera o parziale (dx o sx).

Indicate full or partial handle (R or L) when ordering.

IDROBOX BASI
IDROBOX BASE UNITS

IDROBOX COLONNE E PENSILI
IDROBOX TALL AND WALL UNITS

IDROBOX ATTREZZATURA
IDROBOX EQUIPMENT

IDROBOX TOP E LAVATOI
IDROBOX TOPS AND WASHBASINS

INGRESSI
HALLWAY CABINETS

SCARPIERE
SHOE CABINETS

ACCESSORI
ACCESSORIES

PENSILI H 60 cm

Wall units h 60 cm

GOLA UP

1 anta ribalta

1 lift-up door

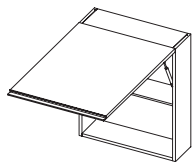

1 ripiano legno
1 wooden shelf

L W	H H	P D	CODICE CODE
--------	--------	--------	----------------

P 20	45	60	20	DGPS6521
	60	60	20	DGPS6531
	75	60	20	DGPS6541
	90	60	20	DGPS6551

P 35	45	60	35	DGPS6522
	60	60	35	DGPS6532
	75	60	35	DGPS6542
	90	60	35	DGPS6552

Materico Textured finish	Lacc. opaco Matt lacq.	Lacc. lucido Glossy lacq.	Essenza Wood	Superfici UP UP surface
-----------------------------	---------------------------	------------------------------	-----------------	----------------------------

449	545	620	717	654
485	592	679	786	714
521	640	736	856	775
574	705	810	941	853

538	653	746	859	785
582	711	814	943	857
625	768	884	1.028	929
688	845	971	1.130	1.021

1 anta ribalta telaio

1 lift-up framed door

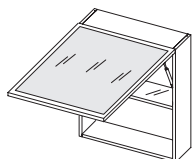

1 ripiano cristallo
1 glass shelf

L W	H H	P D	CODICE CODE
--------	--------	--------	----------------

P 20	45	60	20	DGPT6521
	60	60	20	DGPT6531
	75	60	20	DGPT6541
	90	60	20	DGPT6551

Materico Textured finish	Lacc. opaco Matt lacq.	Lacc. lucido Glossy lacq.	Essenza Wood	Superfici UP UP surface
-----------------------------	---------------------------	------------------------------	-----------------	----------------------------

559	600	640	681	650
611	656	702	748	711
668	721	771	823	782
725	785	840	899	854

Indicare in fase d'ordine se inserire la maniglia intera o parziale (dx o sx).

Indicate full or partial handle (R or L) when ordering.

PENSILI H 60 cm

Wall units h 60 cm

GOLA UP

1 anta dx o sx

1 R or L door

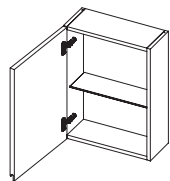

1 ripiano legno

1 wooden shelf

L W	H H	P D	CODICE CODE
--------	--------	--------	----------------

P 20	30	60	20	DGPS8511
	45	60	20	DGPS8521
	60	60	20	DGPS8531

P 35	30	60	35	DGPS8512
	45	60	35	DGPS8522
	60	60	35	DGPS8532

Materico Textured finish	Lacc. opaco Matt lacq.	Lacc. lucido Glossy lacq.	Essenza Wood	Superfici UP UP surface
-----------------------------	---------------------------	------------------------------	-----------------	----------------------------

359	443	519	610	548
390	486	573	677	603
422	530	625	741	659

430	532	623	744	656
467	583	687	825	723
506	634	751	904	791

1 anta telaio dx o sx

1 L or R framed door

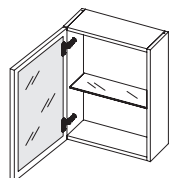

1 ripiano cristallo

1 glass shelf

L W	H H	P D	CODICE CODE
--------	--------	--------	----------------

P 20	30	60	20	DGPT8511
	45	60	20	DGPT8521
	60	60	20	DGPT8531

P 35	30	60	35	DGPT8512
	45	60	35	DGPT8522
	60	60	35	DGPT8532

Materico Textured finish	Lacc. opaco Matt lacq.	Lacc. lucido Glossy lacq.	Essenza Wood	Superfici UP UP surface
-----------------------------	---------------------------	------------------------------	-----------------	----------------------------

515	569	633	722	652
559	613	680	766	697
604	659	727	810	742

617	683	759	866	782
670	737	816	918	836
725	790	872	972	891

Indicare in fase d'ordine se inserire la maniglia intera o parziale (dx o sx).

Indicate full or partial handle (R or L) when ordering.

IDROBOX BASI
IDROBOX BASE UNITS

IDROBOX COLONNE E PENSILI
IDROBOX TALL AND WALL UNITS

IDROBOX ATTREZZATURA
IDROBOX EQUIPMENT

IDROBOX TOP E LAVATOI
IDROBOX TOPS AND WASHBASINS

INGRESSI
HALLWAY CABINETS

SCARPIERE
SHOE CABINETS

ACCESSORI
ACCESSORIES

PENSILI H 60 cm

Wall units h 60 cm

GOLA UP

2 ante

2 doors

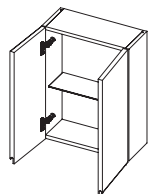

1 ripiano legno

1 wooden shelf

L W	H H	P D	CODICE CODE
--------	--------	--------	----------------

P 20	60	60	20	DGPS9531
	75	60	20	DGPS9541
	90	60	20	DGPS9551

P 35	60	60	35	DGPS9532
	75	60	35	DGPS9542
	90	60	35	DGPS9552

Materico Textured finish	Lacc. opaco Matt lacq.	Lacc. lucido Glossy lacq.	Essenza Wood	Superfici UP UP surface
-----------------------------	---------------------------	------------------------------	-----------------	----------------------------

491	616	700	816	739
528	678	782	918	828
562	739	863	1.021	916

589	738	841	995	887
632	813	939	1.120	994
674	886	1.035	1.246	1.099

2 ante telaio

2 framed doors

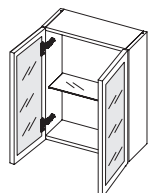

1 ripiano cristallo

1 glass shelf

L W	H H	P D	CODICE CODE
--------	--------	--------	----------------

P 20	60	60	20	DGPT9531
	75	60	20	DGPT9541
	90	60	20	DGPT9551

P 35	60	60	35	DGPT9532
	75	60	35	DGPT9542
	90	60	35	DGPT9552

Materico Textured finish	Lacc. opaco Matt lacq.	Lacc. lucido Glossy lacq.	Essenza Wood	Superfici UP UP surface
-----------------------------	---------------------------	------------------------------	-----------------	----------------------------

658	704	749	794	758
710	763	813	866	823
763	821	875	936	889

744	795	872	950	883
802	862	945	1.033	960
862	928	1.020	1.117	1.035

Indicare in fase d'ordine se inserire la maniglia intera o parziale (dx o sx).

Indicate full or partial handle (R or L) when ordering.

PENSILI H 75 cm

Wall units h 75 cm

GOLA UP

1 anta dx o sx

1 R or L door

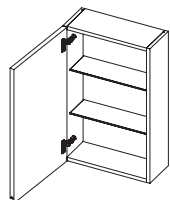

2 ripiani legno
2 wooden shelves

L W	H H	P D	CODICE CODE
--------	--------	--------	----------------

P 20	30	75	20	DGPS8611
	45	75	20	DGPS8621
	60	75	20	DGPS8631

P 35	30	75	35	DGPS8612
	45 <td>75 <td>35</td> <td>DGPS8622</td> </td>	75 <td>35</td> <td>DGPS8622</td>	35	DGPS8622
	60 <td>75 <td>35</td> <td>DGPS8632</td> </td>	75 <td>35</td> <td>DGPS8632</td>	35	DGPS8632

Materico Textured finish	Lacc. opaco Matt lacq.	Lacc. lucido Glossy lacq.	Essenza Wood	Superfici UP UP surface
-----------------------------	---------------------------	------------------------------	-----------------	----------------------------

389	480	563	663	594
423	528	620	734	654
457	574	679	805	714

466	576	675	807	712
508	632	746	895	785
549	690	814	982	857

1 anta telaio dx o sx

1 L or R framed door

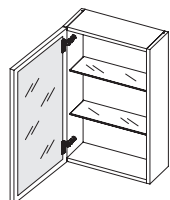

2 ripiani cristallo
2 glass shelves

L W	H H	P D	CODICE CODE
--------	--------	--------	----------------

P 20	30	75	20	DGPT8611
	45 <th>75</th> <th>20</th> <th>DGPT8621</th>	75	20	DGPT8621
	60 <th>75</th> <th>20</th> <th>DGPT8631</th>	75	20	DGPT8631

P 35	30	75	35	DGPT8612
	45 <th>75</th> <th>35</th> <th>DGPT8622</th>	75	35	DGPT8622
	60 <th>75</th> <th>35</th> <th>DGPT8632</th>	75	35	DGPT8632

Materico Textured finish	Lacc. opaco Matt lacq.	Lacc. lucido Glossy lacq.	Essenza Wood	Superfici UP UP surface
-----------------------------	---------------------------	------------------------------	-----------------	----------------------------

558	618	687	782	708
606	666	738	831	756
669	740	825	939	849

669	740	825	939	849
727	799	885	997	908
786	857	947	1.056	967

Indicare in fase d'ordine se inserire la maniglia intera o parziale (dx o sx).

Indicate full or partial handle (R or L) when ordering.

IDROBOX BASI
IDROBOX BASE UNITS

IDROBOX COLONNE E PENSILI
IDROBOX TALL AND WALL UNITS

IDROBOX ATTREZZATURA
IDROBOX EQUIPMENT

IDROBOX TOP E LAVATOI
IDROBOX TOPS AND WASHBASINS

INGRESSI
HALLWAY CABINETS

SCARPIERE
SHOE CABINETS

ACCESSORI
ACCESSORIES

PENSILI H 75 cm

Wall units h 75 cm

GOLA UP

2 ante

2 doors

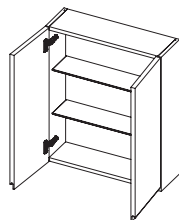

2 ripiani legno

2 wooden shelves

L W	H H	P D	CODICE CODE
--------	--------	--------	----------------

P 20	60	75	20	DGPS9631
	75	75	20	DGPS9641
	90	75	20	DGPS9651

P 35	60	75	35	DGPS9632
	75 <td>75 <td>35</td> <td>DGPS9642</td> </td>	75 <td>35</td> <td>DGPS9642</td>	35	DGPS9642
	90 <td>75 <td>35</td> <td>DGPS9652</td> </td>	75 <td>35</td> <td>DGPS9652</td>	35	DGPS9652

Materico Textured finish	Lacc. opaco Matt lacq.	Lacc. lucido Glossy lacq.	Essenza Wood	Superfici UP UP surface
-----------------------------	---------------------------	------------------------------	-----------------	----------------------------

533	667	761	885	802
572	735	849	997	898
610	802	937	1.107	994

639	801	913	1.079	962
685	882	1.018	1.215	1.077
732	962	1.125	1.352	1.192

2 ante telaio

2 framed doors

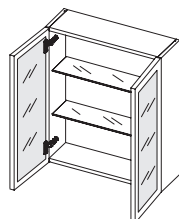

2 ripiani cristallo

2 glass shelves

L W	H H	P D	CODICE CODE
--------	--------	--------	----------------

P 20	60	75	20	DGPT9631
	75 <td>75 <td>20</td> <td>DGPT9641</td> </td>	75 <td>20</td> <td>DGPT9641</td>	20	DGPT9641
	90 <td>75 <td>20</td> <td>DGPT9651</td> </td>	75 <td>20</td> <td>DGPT9651</td>	20	DGPT9651

P 35	60	75	35	DGPT9632
	75 <td>75 <td>35</td> <td>DGPT9642</td> </td>	75 <td>35</td> <td>DGPT9642</td>	35	DGPT9642
	90 <td>75 <td>35</td> <td>DGPT9652</td> </td>	75 <td>35</td> <td>DGPT9652</td>	35	DGPT9652

Materico Textured finish	Lacc. opaco Matt lacq.	Lacc. lucido Glossy lacq.	Essenza Wood	Superfici UP UP surface
-----------------------------	---------------------------	------------------------------	-----------------	----------------------------

713	763	813	862	822
771	827	882	939	894
827	891	951	1.015	966

856	915	975	1.034	987
925	992	1.058	1.126	1.073
992	1.070	1.141	1.218	1.158

Indicare in fase d'ordine se inserire la maniglia intera o parziale (dx o sx).

Indicate full or partial handle (R or L) when ordering.

PENSILI H 90 cm

Wall units h 90 cm

GOLA UP

1 anta dx o sx

1 R or L door

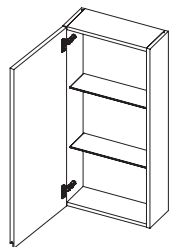

2 ripiani legno
2 wooden shelves

L W	H H	P D	CODICE CODE
--------	--------	--------	----------------

P 20	30	90	20	DGPS8811
	45	90	20	DGPS8821
	60	90	20	DGPS8831

P 35	30	90	35	DGPS8812
	45	90	35	DGPS8822
	60	90	35	DGPS8832

Materico Textured finish	Lacc. opaco Matt lacq.	Lacc. lucido Glossy lacq.	Essenza Wood	Superfici UP UP surface
-----------------------------	---------------------------	------------------------------	-----------------	----------------------------

422	521	611	719	645
459	573	674	795	710
496	623	736	873	776

506	625	733	875	773
550	687	808	970	852
596	748	883	1.064	929

1 anta telaio dx o sx

1 L or R framed door

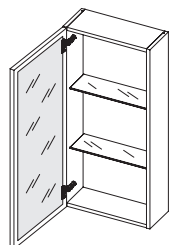

2 ripiani cristallo
2 glass shelves

L W	H H	P D	CODICE CODE
--------	--------	--------	----------------

P 20	30	90	20	DGPT8811
	45	90	20	DGPT8821
	60	90	20	DGPT8831

P 35	30	90	35	DGPT8812
	45	90	35	DGPT8822
	60	90	35	DGPT8832

Materico Textured finish	Lacc. opaco Matt lacq.	Lacc. lucido Glossy lacq.	Essenza Wood	Superfici UP UP surface
-----------------------------	---------------------------	------------------------------	-----------------	----------------------------

605	670	746	849	767
658	723	801	901	821
711	776	856	954	873

725	804	895	1.019	922
790	867	961	1.083	984
853	929	1.028	1.145	1.048

Indicare in fase d'ordine se inserire la maniglia intera o parziale (dx o sx).

Indicate full or partial handle (R or L) when ordering.

IDROBOX BASI
IDROBOX BASE UNITS

IDROBOX COLONNE E PENSILI
IDROBOX TALL AND WALL UNITS

IDROBOX ATTREZZATURA
IDROBOX EQUIPMENT

IDROBOX TOP E LAVATOI
IDROBOX TOPS AND WASHBASINS

INGRESSI
HALLWAY CABINETS

SCARPIERE
SHOE CABINETS

ACCESSORI
ACCESSORIES

PENSILI H 90 cm

Wall units h 90 cm

GOLA UP

2 ante
2 doors

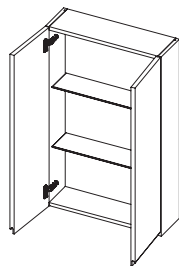

2 ripiani legno
2 wooden shelves

L W	H H	P D	CODICE CODE
--------	--------	--------	----------------

P 20	60	90	20	DGPS9831
	75	90	20	DGPS9841
	90	90	20	DGPS9851

P 35	60	90	35	DGPS9832
	75	90	35	DGPS9842
	90	90	35	DGPS9852

Materico Textured finish	Lacc. opaco Matt lacq.	Lacc. lucido Glossy lacq.	Essenza Wood	Superfici UP UP surface
-----------------------------	---------------------------	------------------------------	-----------------	----------------------------

577	724	826	961	870
619	796	922	1.082	974
661	870	1.016	1.203	1.078

693	869	990	1.172	1.044
742	956	1.104	1.319	1.169
794	1.044	1.220	1.466	1.293

2 ante telaio
2 framed doors

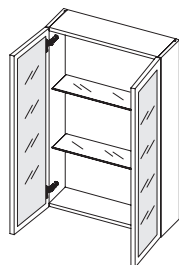

2 ripiani cristallo
2 glass shelves

L W	H H	P D	CODICE CODE
--------	--------	--------	----------------

P 20	60	90	20	DGPT9831
	75	90	20	DGPT9841
	90	90	20	DGPT9851

P 35	60	90	35	DGPT9832
	75	90	35	DGPT9842
	90	90	35	DGPT9852

Materico Textured finish	Lacc. opaco Matt lacq.	Lacc. lucido Glossy lacq.	Essenza Wood	Superfici UP UP surface
-----------------------------	---------------------------	------------------------------	-----------------	----------------------------

775	828	882	936	893
836	898	956	1.018	969
897	967	1.031	1.101	1.047

929	994	1.058	1.122	1.071
1.003	1.076	1.147	1.221	1.164
1.076	1.160	1.237	1.320	1.257

Indicare in fase d'ordine se inserire la maniglia intera o parziale (dx o sx).

Indicate full or partial handle (R or L) when ordering.

PENSILI H 105 cm

Wall units h 105 cm

GOLA UP

1 anta dx o sx

1 R or L door

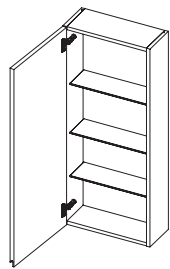

3 ripiani legno
3 wooden shelves

L W	H H	P D	CODICE CODE
--------	--------	--------	----------------

P 20	30	105	20	DGPS8911
	45	105	20	DGPS8921
	60	105	20	DGPS8931

P 35	30	105	35	DGPS8912
	45 <td>105 <td>35 <td>DGPS8922</td> </td></td>	105 <td>35 <td>DGPS8922</td> </td>	35 <td>DGPS8922</td>	DGPS8922
	60 <td>105 <td>35 <td>DGPS8932</td> </td></td>	105 <td>35 <td>DGPS8932</td> </td>	35 <td>DGPS8932</td>	DGPS8932

Materico Textured finish	Lacc. opaco Matt lacq.	Lacc. lucido Glossy lacq.	Essenza Wood	Superfici UP UP surface
-----------------------------	---------------------------	------------------------------	-----------------	----------------------------

450	555	651	765	687
489	609	718	848	755
529	664	783	929	826

538	666	780	933	823
587	732	860	1.033	908
634	795	941	1.133	990

1 anta telaio dx o sx

1 L or R framed door

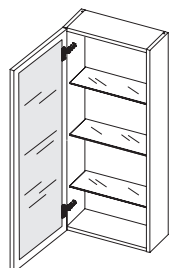

3 ripiani cristallo
3 glass shelves

L W	H H	P D	CODICE CODE
--------	--------	--------	----------------

P 20	30	105	20	DOM285T
	45 <td>105 <td>20 <td>DOM287T</td> </td></td>	105 <td>20 <td>DOM287T</td> </td>	20 <td>DOM287T</td>	DOM287T
	60 <td>105 <td>20 <td>DOM289T</td> </td></td>	105 <td>20 <td>DOM289T</td> </td>	20 <td>DOM289T</td>	DOM289T

P 35	30	105	35	DOM286T
	45 <td>105 <td>35 <td>DOM288T</td> </td></td>	105 <td>35 <td>DOM288T</td> </td>	35 <td>DOM288T</td>	DOM288T
	60 <td>105 <td>35 <td>DOM290T</td> </td></td>	105 <td>35 <td>DOM290T</td> </td>	35 <td>DOM290T</td>	DOM290T

Materico Textured finish	Lacc. opaco Matt lacq.	Lacc. lucido Glossy lacq.	Essenza Wood	Superfici UP UP surface
-----------------------------	---------------------------	------------------------------	-----------------	----------------------------

644	713	794	904	817
700	769	853	960	874
756	826	912	1.016	930

773	856	953	1.085	981
841	924	1.023	1.152	1.048
909	990	1.093	1.219	1.116

Indicare in fase d'ordine se inserire la maniglia intera o parziale (dx o sx).

Indicate full or partial handle (R or L) when ordering.

IDROBOX BASI
IDROBOX BASE UNITS

IDROBOX COLONNE E PENSILI
IDROBOX TALL AND WALL UNITS

IDROBOX ATTREZZATURA
IDROBOX EQUIPMENT

IDROBOX TOP E LAVATOI
IDROBOX TOPS AND WASHBASINS

INGRESSI
HALLWAY CABINETS

SCARPIERE
SHOE CABINETS

ACCESSORI
ACCESSORIES

PENSILI H 105 cm

Wall units h 105 cm

GOLA UP

2 ante

2 doors

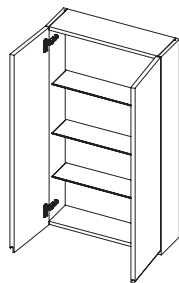

3 ripiani legno

3 wooden shelves

L W	H H	P D	CODICE CODE
--------	--------	--------	----------------

P 20	60	105	20	DGPS9931
	75	105	20	DGPS9941
	90	105	20	DGPS9951

P 35	60	105	35	DGPS9932
	75	105	35	DGPS9942
	90	105	35	DGPS9952

Materico Textured finish	Lacc. opaco Matt lacq.	Lacc. lucido Glossy lacq.	Essenza Wood	Superfici UP UP surface
-----------------------------	---------------------------	------------------------------	-----------------	----------------------------

616	771	880	1.023	927
660	849	981	1.151	1.038
705	925	1.083	1.280	1.149

738	925	1.055	1.248	1.113
792	1.018	1.177	1.404	1.245
845	1.112	1.298	1.562	1.377

2 ante telaio

2 framed doors

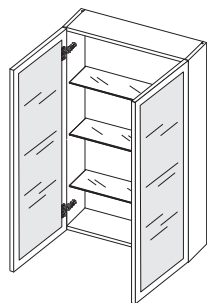

3 ripiani cristallo

3 glass shelves

L W	H H	P D	CODICE CODE
--------	--------	--------	----------------

P 20	60	105	20	DGPT9931
	75	105	20	DGPT9941
	90	105	20	DGPT9951

P 35	60	105	35	DGPT9932
	75	105	35	DGPT9942
	90	105	35	DGPT9952

Materico Textured finish	Lacc. opaco Matt lacq.	Lacc. lucido Glossy lacq.	Essenza Wood	Superfici UP UP surface
-----------------------------	---------------------------	------------------------------	-----------------	----------------------------

825	882	939	996	951
889	955	1.018	1.084	1.032
955	1.030	1.099	1.172	1.115

989	1.058	1.127	1.194	1.141
1.069	1.146	1.222	1.301	1.238
1.146	1.235	1.318	1.407	1.338

Indicare in fase d'ordine se inserire la maniglia intera o parziale (dx o sx).

Indicate full or partial handle (R or L) when ordering.

COLONNE H 120 cm

Tall units h 120 cm

GOLA UP

1 anta dx o sx

1 R or L door

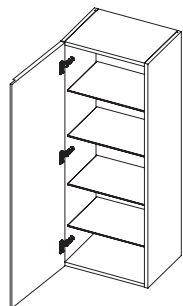

4 ripiani legno
4 wooden shelves

L W	H H	P D	CODICE CODE
--------	--------	--------	----------------

P 20	30	120	20	DGC08A11
	45	120	20	DGC08A21
	60	120	20	DGC08A31

P 35	30	120	35	DGC08A12
	45	120	35	DGC08A22
	60	120	35	DGC08A32

Materico Textured finish	Lacc. opaco Matt lacq.	Lacc. lucido Glossy lacq.	Essenza Wood	Superfici UP UP surface
-----------------------------	---------------------------	------------------------------	-----------------	----------------------------

437	565	671	800	714
503	670	792	965	850
569	775	913	1.129	985

524	696	833	1.001	885
603	825	982	1.205	1.053
682	953	1.132	1.410	1.221

1 anta telaio dx o sx

1 L or R framed door

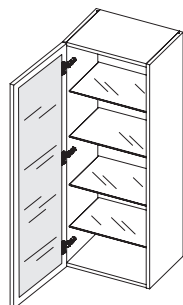

4 ripiani cristallo
4 glass shelves

L W	H H	P D	CODICE CODE
--------	--------	--------	----------------

P 20	30	120	20	DGCT8A11
	45	120	20	DGCT8A21
	60	120	20	DGCT8A31

P 35	30	120	35	DGCT8A12
	45	120	35	DGCT8A22
	60	120	35	DGCT8A32

Materico Textured finish	Lacc. opaco Matt lacq.	Lacc. lucido Glossy lacq.	Essenza Wood	Superfici UP UP surface
-----------------------------	---------------------------	------------------------------	-----------------	----------------------------

594	646	711	772	735
687	746	813	879	834
779	844	914	984	933

680	772	868	967	901
785	896	998	1.113	1.032
889	1.018	1.128	1.260	1.164

Indicare in fase d'ordine se inserire la maniglia intera o parziale (inferiore o superiore).

Indicate full or partial handle (lower or upper) when ordering.

IDROBOX BASI
IDROBOX BASE UNITS

IDROBOX COLONNE E PENSILI
IDROBOX TALL AND WALL UNITS

IDROBOX ATTREZZATURA
IDROBOX EQUIPMENT

IDROBOX TOP E LAVATOI
IDROBOX TOPS AND WASHBASINS

INGRESSI
HALLWAY CABINETS

SCARPIERE
SHOE CABINETS

ACCESSORI
ACCESSORIES

COLONNE H 120 cm

Tall units h 120 cm

GOLA UP

2 ante
2 doors

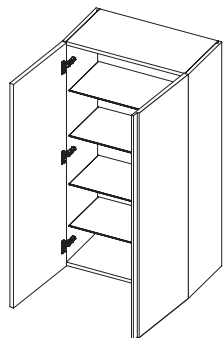

4 ripiani legno
4 wooden shelves

L W	H H	P D	CODICE CODE
--------	--------	--------	----------------

P 20	60	120	20	DGC09A31
	75	120	20	DGC09A41

P 35	60	120	35	DGC09A32
	75	120	35	DGC09A42

Materico Textured finish	Lacc. opaco Matt lacq.	Lacc. lucido Glossy lacq.	Essenza Wood	Superfici UP UP surface
-----------------------------	---------------------------	------------------------------	-----------------	----------------------------

640	856	1.014	1.220	1.103
725	989	1.169	1.426	1.279

759	1.035	1.236	1.500	1.346
858	1.196	1.425	1.754	1.560

2 ante telaio
2 framed doors

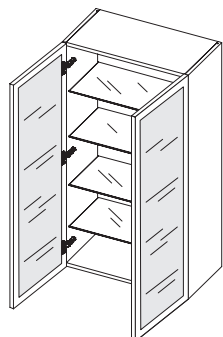

4 ripiani cristallo
4 glass shelves

L W	H H	P D	CODICE CODE
--------	--------	--------	----------------

P 20	60	120	20	DGCT9A31
	75	120	20	DGCT9A41

P 35	60	120	35	DGCT9A32
	75	120	35	DGCT9A42

Materico Textured finish	Lacc. opaco Matt lacq.	Lacc. lucido Glossy lacq.	Essenza Wood	Superfici UP UP surface
-----------------------------	---------------------------	------------------------------	-----------------	----------------------------

967	1.032	1.102	1.172	1.120
1.089	1.141	1.223	1.266	1.254

1.077	1.206	1.316	1.448	1.352
1.214	1.332	1.461	1.564	1.512

Indicare in fase d'ordine se inserire la maniglia intera o parziale (inferiore o superiore).

Indicate full or partial handle (lower or upper) when ordering.

COLONNE H 135 cm

Tall units h 135 cm

GOLA UP

1 anta dx o sx

1 R or L door

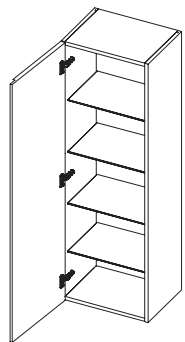

4 ripiani legno
4 wooden shelves

L W	H H	P D	CODICE CODE
--------	--------	--------	----------------

P 20	30	135	20	DGC08B11
	45	135	20	DGC08B21
	60	135	20	DGC08B31

P 35	30	135	35	DGC08B12
	45	135	35	DGC08B22
	60	135	35	DGC08B32

Materico Textured finish	Lacc. opaco Matt lacq.	Lacc. lucido Glossy lacq.	Essenza Wood	Superfici UP UP surface
-----------------------------	---------------------------	------------------------------	-----------------	----------------------------

465	609	726	870	769
536	722	857	1.048	915
606	834	988	1.225	1.061

559	749	900	1.087	954
642	887	1.062	1.309	1.134
727	1.025	1.224	1.533	1.316

1 anta telaio dx o sx

1 L or R framed door

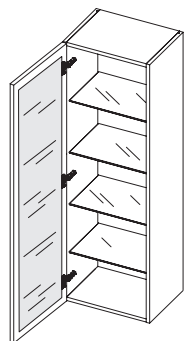

4 ripiani cristallo
4 glass shelves

L W	H H	P D	CODICE CODE
--------	--------	--------	----------------

P 20	30	135	20	DGCT8B11
	45	135	20	DGCT8B21
	60	135	20	DGCT8B31

P 35	30	135	35	DGCT8B12
	45	135	35	DGCT8B22
	60	135	35	DGCT8B32

Materico Textured finish	Lacc. opaco Matt lacq.	Lacc. lucido Glossy lacq.	Essenza Wood	Superfici UP UP surface
-----------------------------	---------------------------	------------------------------	-----------------	----------------------------

634	695	763	828	783
734	798	864	940	883
834	901	967	1.052	981

724	831	931	1.039	963
839	960	1.064	1.195	1.097
953	1.088	1.198	1.350	1.230

Indicare in fase d'ordine se inserire la maniglia intera o parziale (inferiore o superiore).

Indicate full or partial handle (lower or upper) when ordering.

IDROBOX BASI
IDROBOX BASE UNITS

IDROBOX COLONNE E PENSILI
IDROBOX TALL AND WALL UNITS

IDROBOX ATTREZZATURA
IDROBOX EQUIPMENT

IDROBOX TOP E LAVATOI
IDROBOX TOPS AND WASHBASINS

INGRESSI
HALLWAY CABINETS

SCARPIERE
SHOE CABINETS

ACCESSORI
ACCESSORIES

COLONNE H 135 cm

Tall units h 135 cm

GOLA UP

2 ante
2 doors

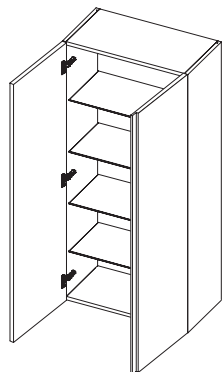

4 ripiani legno
4 wooden shelves

L W	H H	P D	CODICE CODE
--------	--------	--------	----------------

P 20	60	135	20	DGC09B31
	75	135	20	DGC09B41

P 35	60	135	35	DGC09B32
	75	135	35	DGC09B42

Materico Textured finish	Lacc. opaco Matt lacq.	Lacc. lucido Glossy lacq.	Essenza Wood	Superfici UP UP surface
-----------------------------	---------------------------	------------------------------	-----------------	----------------------------

681	915	1.096	1.325	1.173
771	1.058	1.262	1.550	1.360

807	1.107	1.335	1.629	1.431
913	1.280	1.539	1.906	1.659

2 ante telaio
2 framed doors

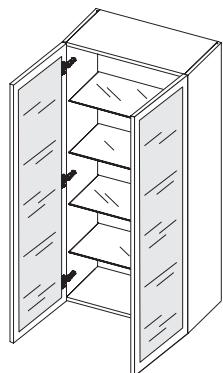

4 ripiani cristallo
4 glass shelves

L W	H H	P D	CODICE CODE
--------	--------	--------	----------------

P 20	60	135	20	DGCT9B31
	75	135	20	DGCT9B41

P 35	60	135	35	DGCT9B32
	75	135	35	DGCT9B42

Materico Textured finish	Lacc. opaco Matt lacq.	Lacc. lucido Glossy lacq.	Essenza Wood	Superfici UP UP surface
-----------------------------	---------------------------	------------------------------	-----------------	----------------------------

1.028	1.100	1.177	1.251	1.195
1.155	1.207	1.304	1.350	1.321

1.145	1.287	1.408	1.550	1.442
1.287	1.412	1.559	1.673	1.596

Indicare in fase d'ordine se inserire la maniglia intera o parziale (inferiore o superiore).

Indicate full or partial handle (lower or upper) when ordering.

COLONNE H 150 cm

Tall units h 150 cm

GOLA UP

1 anta dx o sx

1 R or L door

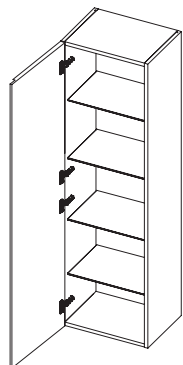

4 ripiani legno
4 wooden shelves

L W	H H	P D	CODICE CODE
--------	--------	--------	----------------

P 20	30	150	20	DGC08C11
	45	150	20	DGC08C21
	60	150	20	DGC08C31

P 35	30	150	35	DGC08C12
	45 <td>150 <td>35 <td>DGC08C22</td> </td></td>	150 <td>35 <td>DGC08C22</td> </td>	35 <td>DGC08C22</td>	DGC08C22
	60 <td>150 <td>35 <td>DGC08C32</td> </td></td>	150 <td>35 <td>DGC08C32</td> </td>	35 <td>DGC08C32</td>	DGC08C32

Materico Textured finish	Lacc. opaco Matt lacq.	Lacc. lucido Glossy lacq.	Essenza Wood	Superfici UP UP surface
-----------------------------	---------------------------	------------------------------	-----------------	----------------------------

494	652	781	939	825
569	772	923	1.131	981
644	893	1.062	1.323	1.137

593	802	969	1.173	1.021
682	950	1.143	1.414	1.215
772	1.098	1.318	1.655	1.409

1 anta telaio dx o sx

1 L or R framed door

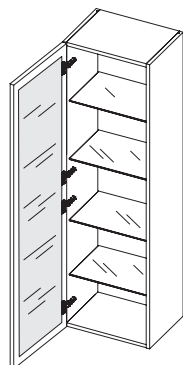

4 ripiani cristallo
4 glass shelves

L W	H H	P D	CODICE CODE
--------	--------	--------	----------------

P 20	30	150	20	DGCT8C11
	45 <th>150</th> <th>20</th> <th>DGCT8C21</th>	150	20	DGCT8C21
	60 <th>150</th> <th>20</th> <th>DGCT8C31</th>	150	20	DGCT8C31

P 35	30	150	35	DGCT8C12
	45 <th>150</th> <th>35</th> <th>DGCT8C22</th>	150	35	DGCT8C22
	60 <th>150</th> <th>35</th> <th>DGCT8C32</th>	150	35	DGCT8C32

Materico Textured finish	Lacc. opaco Matt lacq.	Lacc. lucido Glossy lacq.	Essenza Wood	Superfici UP UP surface
-----------------------------	---------------------------	------------------------------	-----------------	----------------------------

674	744	814	884	833
781	852	915	1.002	930
889	960	1.018	1.119	1.030

769	889	996	1.113	1.025
893	1.025	1.131	1.277	1.160
1.015	1.159	1.266	1.441	1.295

Indicare in fase d'ordine se inserire la maniglia intera o parziale (inferiore o superiore).

Indicate full or partial handle (lower or upper) when ordering.

IDROBOX BASI
IDROBOX BASE UNITS

IDROBOX COLONNE E PENSILI
IDROBOX TALL AND WALL UNITS

IDROBOX ATTREZZATURA
IDROBOX EQUIPMENT

IDROBOX TOP E LAVATOI
IDROBOX TOPS AND WASHBASINS

INGRESSI
HALLWAY CABINETS

SCARPIERE
SHOE CABINETS

ACCESSORI
ACCESSORIES

COLONNE H 150 cm

Tall units h 150 cm

GOLA UP

2 ante
2 doors

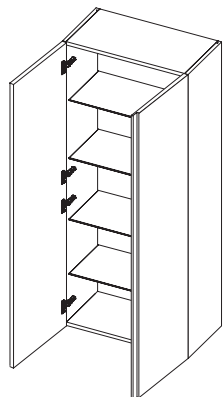

4 ripiani legno
4 wooden shelves

L W	H H	P D	CODICE CODE
--------	--------	--------	----------------

P 20	60	150	20	DGC09C31
	75	150	20	DGC09C41

P 35	60	150	35	DGC09C32
	75	150	35	DGC09C42

Materico Textured finish	Lacc. opaco Matt lacq.	Lacc. lucido Glossy lacq.	Essenza Wood	Superfici UP UP surface
-----------------------------	---------------------------	------------------------------	-----------------	----------------------------

722	975	1.177	1.429	1.244
816	1.128	1.356	1.672	1.441

855	1.180	1.435	1.759	1.516
968	1.363	1.654	2.058	1.759

2 ante telaio
2 framed doors

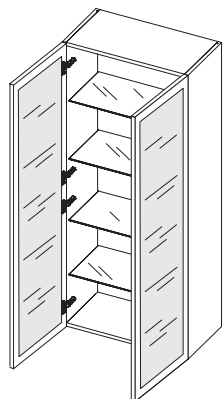

4 ripiani cristallo
4 glass shelves

L W	H H	P D	CODICE CODE
--------	--------	--------	----------------

P 20	60	150	20	DGCT9C31
	75	150	20	DGCT9C41

P 35	60	150	35	DGCT9C32
	75	150	35	DGCT9C42

Materico Textured finish	Lacc. opaco Matt lacq.	Lacc. lucido Glossy lacq.	Essenza Wood	Superfici UP UP surface
-----------------------------	---------------------------	------------------------------	-----------------	----------------------------

1.087	1.166	1.250	1.330	1.268
1.219	1.275	1.383	1.436	1.388

1.213	1.367	1.498	1.653	1.535
1.360	1.494	1.658	1.785	1.679

Indicare in fase d'ordine se inserire la maniglia intera o parziale (inferiore o superiore).

Indicate full or partial handle (lower or upper) when ordering.

COLONNE H 180 cm

Tall units h 180 cm

GOLA UP

1 anta dx o sx

1 R or L door

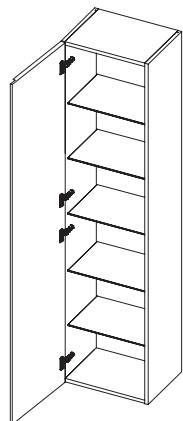

5 ripiani legno
5 wooden shelves

L W	H H	P D	CODICE CODE
--------	--------	--------	----------------

P 20	30	180	20	DGC08D11
	45	180	20	DGC08D21
	60	180	20	DGC08D31

P 35	30	180	35	DGC08D12
	45	180	35	DGC08D22
	60	180	35	DGC08D32

Materico Textured finish	Lacc. opaco Matt lacq.	Lacc. lucido Glossy lacq.	Essenza Wood	Superfici UP UP surface
-----------------------------	---------------------------	------------------------------	-----------------	----------------------------

562	737	903	1.076	945
647	873	1.066	1.296	1.126
732	1.009	1.230	1.517	1.305

674	908	1.119	1.346	1.173
776	1.074	1.321	1.622	1.395
879	1.241	1.523	1.898	1.617

1 anta telaio dx o sx

1 L or R framed door

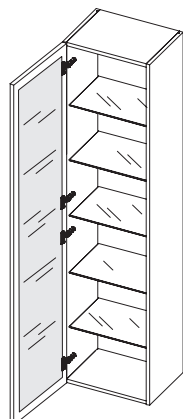

5 ripiani cristallo
5 glass shelves

L W	H H	P D	CODICE CODE
--------	--------	--------	----------------

P 20	30	180	20	DGCT8D11
	45	180	20	DGCT8D21
	60	180	20	DGCT8D31

P 35	30	180	35	DGCT8D12
	45	180	35	DGCT8D22
	60	180	35	DGCT8D32

Materico Textured finish	Lacc. opaco Matt lacq.	Lacc. lucido Glossy lacq.	Essenza Wood	Superfici UP UP surface
-----------------------------	---------------------------	------------------------------	-----------------	----------------------------

766	849	947	1.014	957
888	977	1.070	1.154	1.075
1.010	1.104	1.192	1.292	1.194

875	1.015	1.158	1.276	1.178
1.015	1.173	1.319	1.469	1.339
1.152	1.331	1.479	1.662	1.500

Indicare in fase d'ordine se inserire la maniglia intera o parziale (inferiore o superiore).

Indicate full or partial handle (lower or upper) when ordering.

IDROBOX BASI
IDROBOX BASE UNITS

IDROBOX COLONNE E PENSILI
IDROBOX TALL AND WALL UNITS

IDROBOX ATTREZZATURA
IDROBOX EQUIPMENT

IDROBOX TOP E LAVATOI
IDROBOX TOPS AND WASHBASINS

INGRESSI
HALLWAY CABINETS

SCARPIERE
SHOE CABINETS

ACCESSORI
ACCESSORIES

COLONNE H 180 cm

Tall units h 180 cm

GOLA UP

2 ante
2 doors

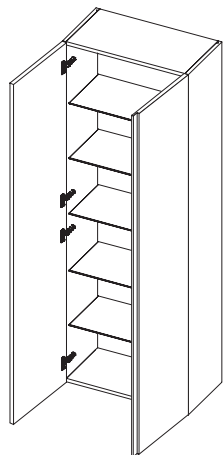

5 ripiani legno
5 wooden shelves

L W	H H	P D	CODICE CODE
--------	--------	--------	----------------

P 20	60	180	20	DGC09D31
	75	180	20	DGC09D41

P 35	60	180	35	DGC09D32
	75	180	35	DGC09D42

Materico Textured finish	Lacc. opaco Matt lacq.	Lacc. lucido Glossy lacq.	Essenza Wood	Superfici UP UP surface
-----------------------------	---------------------------	------------------------------	-----------------	----------------------------

827	1.102	1.339	1.640	1.431
936	1.274	1.543	1.919	1.659

979	1.334	1.632	2.017	1.746
1.107	1.542	1.883	2.359	2.024

2 ante telaio
2 framed doors

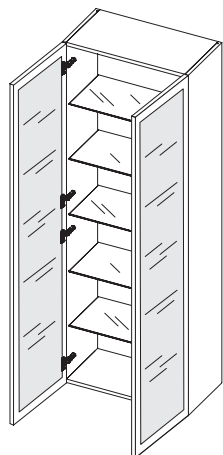

5 ripiani cristallo
5 glass shelves

L W	H H	P D	CODICE CODE
--------	--------	--------	----------------

P 20	60	180	20	DGCT9D31
	75	180	20	DGCT9D41

P 35	60	180	35	DGCT9D32
	75	180	35	DGCT9D42

Materico Textured finish	Lacc. opaco Matt lacq.	Lacc. lucido Glossy lacq.	Essenza Wood	Superfici UP UP surface
-----------------------------	---------------------------	------------------------------	-----------------	----------------------------

1.242	1.335	1.438	1.527	1.465
1.403	1.458	1.566	1.650	1.608

1.384	1.562	1.726	1.896	1.771
1.564	1.705	1.880	2.048	1.943

Indicare in fase d'ordine se inserire la maniglia intera o parziale (inferiore o superiore).

Indicate full or partial handle (lower or upper) when ordering.

COLONNE H 195 cm

Tall units h 195 cm

GOLA UP

1 anta dx o sx

1 R or L door

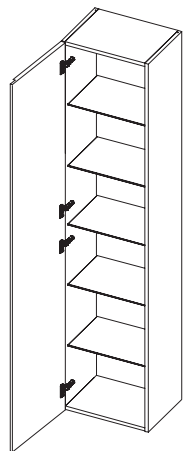

5 ripiani legno

5 wooden shelves

L W	H H	P D	CODICE CODE
--------	--------	--------	----------------

P 20	30	195	20	DGC08E11
	45	195	20	DGC08E21
	60	195	20	DGC08E31

P 35	30	195	35	DGC08E12
	45	195	35	DGC08E22
	60	195	35	DGC08E32

Materico Textured finish	Lacc. opaco Matt lacq.	Lacc. lucido Glossy lacq.	Essenza Wood	Superfici UP UP surface
-----------------------------	---------------------------	------------------------------	-----------------	----------------------------

576	753	939	1.112	977
663	891	1.109	1.339	1.163
750	1.030	1.278	1.568	1.348

691	926	1.164	1.389	1.212
795	1.097	1.375	1.673	1.441
899	1.266	1.585	1.959	1.671

1 anta telaio dx o sx

1 L or R framed door

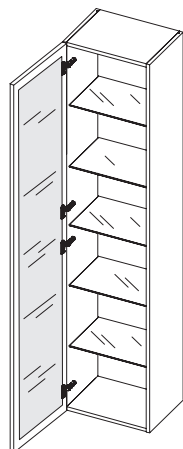

5 ripiani cristallo

5 glass shelves

L W	H H	P D	CODICE CODE
--------	--------	--------	----------------

P 20	30	195	20	DGCT8E11
	45	195	20	DGCT8E21
	60	195	20	DGCT8E31

P 35	30	195	35	DGCT8E12
	45	195	35	DGCT8E22
	60	195	35	DGCT8E32

Materico Textured finish	Lacc. opaco Matt lacq.	Lacc. lucido Glossy lacq.	Essenza Wood	Superfici UP UP surface
-----------------------------	---------------------------	------------------------------	-----------------	----------------------------

786	874	991	1.047	991
911	1.010	1.120	1.194	1.118
1.034	1.145	1.251	1.342	1.246

898	1.043	1.210	1.318	1.220
1.039	1.209	1.381	1.521	1.390
1.181	1.376	1.550	1.724	1.560

Indicare in fase d'ordine se inserire la maniglia intera o parziale (inferiore o superiore).

Indicate full or partial handle (lower or upper) when ordering.

IDROBOX BASI
IDROBOX BASE UNITS

IDROBOX COLONNE E PENSILI
IDROBOX TALL AND WALL UNITS

IDROBOX ATTREZZATURA
IDROBOX EQUIPMENT

IDROBOX TOP E LAVATOI
IDROBOX TOPS AND WASHBASINS

INGRESSI
HALLWAY CABINETS

SCARPIERE
SHOE CABINETS

ACCESSORI
ACCESSORIES

COLONNE H 195 cm

Tall units h 195 cm

GOLA UP

2 ante
2 doors

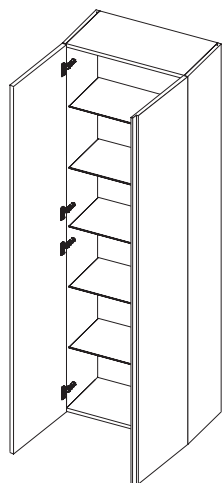

5 ripiani legno
5 wooden shelves

L W	H H	P D	CODICE CODE
--------	--------	--------	----------------

P 20	60	195	20	DGC09E31
	75	195	20	DGC09E41

P 35	60	195	35	DGC09E32
	75	195	35	DGC09E42

Materico Textured finish	Lacc. opaco Matt lacq.	Lacc. lucido Glossy lacq.	Essenza Wood	Superfici UP UP surface
-----------------------------	---------------------------	------------------------------	-----------------	----------------------------

853	1.125	1.373	1.694	1.483
965	1.300	1.583	1.981	1.719

1.010	1.361	1.674	2.083	1.808
1.142	1.572	1.932	2.438	2.098

2 ante telaio
2 framed doors

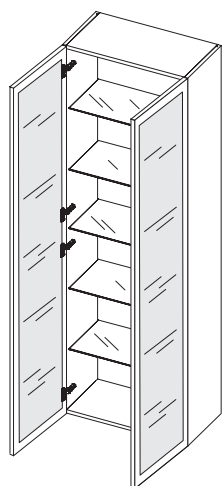

5 ripiani cristallo
5 glass shelves

L W	H H	P D	CODICE CODE
--------	--------	--------	----------------

P 20	60	195	20	DGCT9E31
	75	195	20	DGCT9E41

P 35	60	195	35	DGCT9E32
	75	195	35	DGCT9E42

Materico Textured finish	Lacc. opaco Matt lacq.	Lacc. lucido Glossy lacq.	Essenza Wood	Superfici UP UP surface
-----------------------------	---------------------------	------------------------------	-----------------	----------------------------

1.279	1.377	1.490	1.578	1.522
1.453	1.504	1.600	1.705	1.674

1.425	1.609	1.788	1.960	1.836
1.620	1.755	1.921	2.118	2.021

Indicare in fase d'ordine se inserire la maniglia intera o parziale (inferiore o superiore).

Indicate full or partial handle (lower or upper) when ordering.

COLONNE A TERRA H 210 cm

Floor-standing tall units h 210 cm

GOLA UP

1 anta dx o sx

1 R or L door

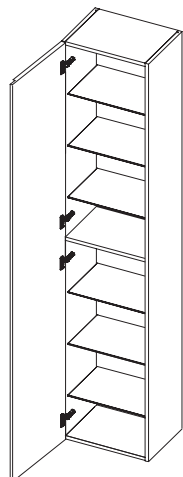

6 ripiani legno
6 wooden shelves

L W	H H	P D	CODICE CODE
--------	--------	--------	----------------

P 20	30	210	20	DGC08F11
	45	210	20	DGC08F21
	60	210	20	DGC08F31

P 35	30	210	35	DGC08F12
	45	210	35	DGC08F22
	60	210	35	DGC08F32

Materico Textured finish	Lacc. opaco Matt lacq.	Lacc. lucido Glossy lacq.	Essenza Wood	Superfici UP UP surface
-----------------------------	---------------------------	------------------------------	-----------------	----------------------------

638	840	1.047	1.249	1.089
735	995	1.236	1.505	1.295
831	1.150	1.424	1.761	1.502

766	1.033	1.298	1.560	1.350
882	1.223	1.533	1.880	1.608
997	1.413	1.766	2.200	1.862

1 anta telaio dx o sx

1 L or R framed door

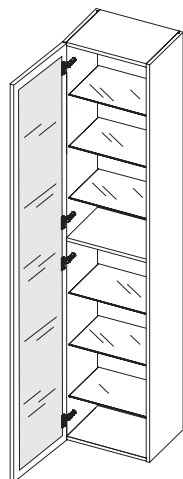

6 ripiani cristallo
6 glass shelves

L W	H H	P D	CODICE CODE
--------	--------	--------	----------------

P 20	30	210	20	DGCT8F11
	45	210	20	DGCT8F21
	60	210	20	DGCT8F31

P 35	30	210	35	DGCT8F12
	45	210	35	DGCT8F22
	60	210	35	DGCT8F32

Materico Textured finish	Lacc. opaco Matt lacq.	Lacc. lucido Glossy lacq.	Essenza Wood	Superfici UP UP surface
-----------------------------	---------------------------	------------------------------	-----------------	----------------------------

870	976	1.105	1.177	1.104
1.010	1.126	1.250	1.342	1.246
1.149	1.276	1.396	1.508	1.387

995	1.164	1.350	1.480	1.360
1.152	1.348	1.539	1.709	1.549
1.311	1.533	1.728	1.937	1.738

Indicare in fase d'ordine se inserire la maniglia intera o parziale (inferiore o superiore).
Inclusi piedini regolabili a scomparsa H 1,6 cm. Zoccolo optional H 6 cm (pagina 189).

Indicate full or partial handle (lower or upper) when ordering.
Hidden adjustable feet H 1,6 cm included. Optional plinth H 6 cm (page 189).

IDROBOX BASI
IDROBOX BASE UNITS

IDROBOX COLONNE E PENSILI
IDROBOX TALL AND WALL UNITS

IDROBOX ATTREZZATURA
IDROBOX EQUIPMENT

IDROBOX TOP E LAVATOI
IDROBOX TOPS AND WASHBASINS

INGRESSI
HALLWAY CABINETS

SCARPIERE
SHOE CABINETS

ACCESSORI
ACCESSORIES

COLONNE A TERRA H 210 cm

Floor-standing tall units h 210 cm

GOLA UP

2 ante
2 doors

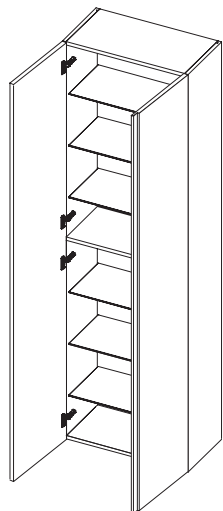

6 ripiani legno
6 wooden shelves

L W	H H	P D	CODICE CODE
--------	--------	--------	----------------

P 20	60	210	20	DGC09F31
	75	210	20	DGC09F41

P 35	60	210	35	DGC09F32
	75	210	35	DGC09F42

Materico Textured finish	Lacc. opaco Matt lacq.	Lacc. lucido Glossy lacq.	Essenza Wood	Superfici UP UP surface
-----------------------------	---------------------------	------------------------------	-----------------	----------------------------

944	1.254	1.531	1.903	1.653
1.069	1.451	1.764	2.226	1.916

1.119	1.519	1.867	2.341	2.017
1.266	1.755	2.153	2.738	2.339

2 ante telaio
2 framed doors

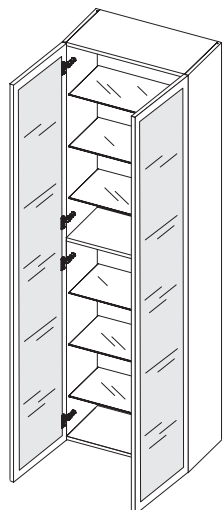

6 ripiani cristallo
6 glass shelves

L W	H H	P D	CODICE CODE
--------	--------	--------	----------------

P 20	60	210	20	DGCT9F31
	75	210	20	DGCT9F41

P 35	60	210	35	DGCT9F32
	75	210	35	DGCT9F42

Materico Textured finish	Lacc. opaco Matt lacq.	Lacc. lucido Glossy lacq.	Essenza Wood	Superfici UP UP surface
-----------------------------	---------------------------	------------------------------	-----------------	----------------------------

1.416	1.537	1.662	1.773	1.697
1.610	1.679	1.786	1.916	1.867

1.578	1.795	1.995	2.202	2.048
1.793	1.960	2.145	2.380	2.254

Indicare in fase d'ordine se inserire la maniglia intera o parziale (inferiore o superiore).
Inclusi piedini regolabili a scomparsa H 1,6 cm. Zoccolo optional H 6 cm (pagina 189).

Indicate full or partial handle (lower or upper) when ordering.
Hidden adjustable feet H 1,6 cm included. Optional plinth H 6 cm (page 189).

COLONNE A TERRA H 240 cm

Floor-standing tall units h 240 cm

GOLA UP

1 anta dx o sx

1 R or L door

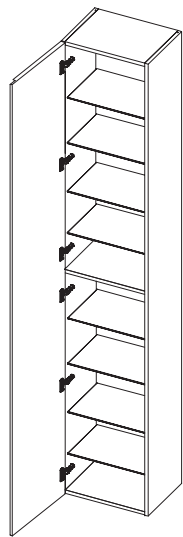

8 ripiani legno
8 wooden shelves

L W	H H	P D	CODICE CODE
--------	--------	--------	----------------

P 20	30	240	20	DGC08H11
	45	240	20	DGC08H21
	60	240	20	DGC08H31

P 35	30	240	35	DGC08H12
	45	240	35	DGC08H22
	60	240	35	DGC08H32

Materico Textured finish	Lacc. opaco Matt lacq.	Lacc. lucido Glossy lacq.	Essenza Wood	Superfici UP UP surface
-----------------------------	---------------------------	------------------------------	-----------------	----------------------------

692	903	1.117	1.327	1.169
795	1.071	1.319	1.599	1.390
900	1.237	1.521	1.872	1.612

829	1.112	1.385	1.658	1.449
954	1.317	1.636	2.000	1.724
1.079	1.522	1.886	2.340	1.997

1 anta telaio dx o sx

1 L or R framed door

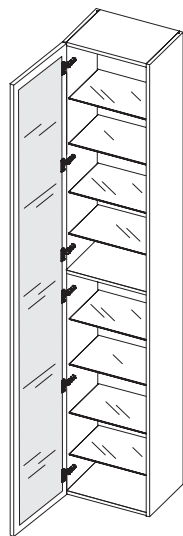

8 ripiani cristallo
8 glass shelves

L W	H H	P D	CODICE CODE
--------	--------	--------	----------------

P 20	30	240	20	DGCT8H11
	45	240	20	DGCT8H21
	60	240	20	DGCT8H31

P 35	30	240	35	DGCT8H12
	45	240	35	DGCT8H22
	60	240	35	DGCT8H32

Materico Textured finish	Lacc. opaco Matt lacq.	Lacc. lucido Glossy lacq.	Essenza Wood	Superfici UP UP surface
-----------------------------	---------------------------	------------------------------	-----------------	----------------------------

940	1.050	1.180	1.250	1.185
1.090	1.212	1.335	1.425	1.336
1.242	1.373	1.491	1.600	1.487

1.074	1.252	1.442	1.573	1.458
1.246	1.452	1.644	1.815	1.662
1.417	1.651	1.846	2.056	1.865

Indicare in fase d'ordine se inserire la maniglia intera o parziale (inferiore o superiore).
Inclusi piedini regolabili a scomparsa H 1,6 cm. Zoccolo optional H 6 cm (pagina 189).

Indicate full or partial handle (lower or upper) when ordering.
Hidden adjustable feet H 1,6 cm included. Optional plinth H 6 cm (page 189).

IDROBOX BASI
IDROBOX BASE UNITS

IDROBOX COLONNE E PENSILI
IDROBOX TALL AND WALL UNITS

IDROBOX ATTREZZATURA
IDROBOX EQUIPMENT

IDROBOX TOP E LAVATOI
IDROBOX TOPS AND WASHBASINS

INGRESSI
HALLWAY CABINETS

SCARPIERE
SHOE CABINETS

ACCESSORI
ACCESSORIES

COLONNE A TERRA H 240 cm

Floor-standing tall units h 240 cm

GOLA UP

2 ante
2 doors

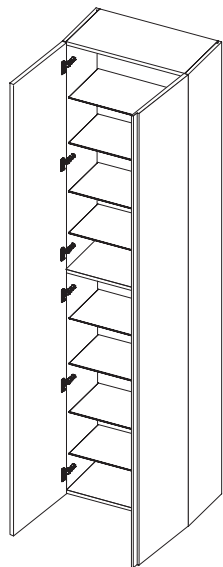

8 ripiani legno
8 wooden shelves

L W	H H	P D	CODICE CODE
--------	--------	--------	----------------

P 20	60	240	20	DGC09H31
	75	240	20	DGC09H41

P 35	60	240	35	DGC09H32
	75	240	35	DGC09H42

Materico Textured finish	Lacc. opaco Matt lacq.	Lacc. lucido Glossy lacq.	Essenza Wood	Superfici UP UP surface
-----------------------------	---------------------------	------------------------------	-----------------	----------------------------

1.038	1.396	1.701	2.121	1.836
1.173	1.613	1.962	2.481	2.129

1.230	1.689	2.076	2.608	2.241
1.390	1.952	2.394	3.051	2.599

2 ante telaio
2 framed doors

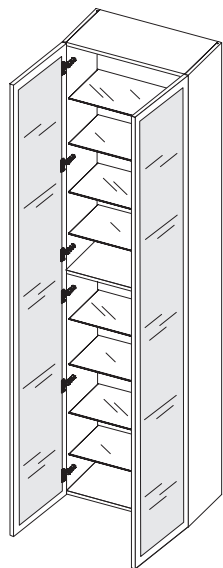

8 ripiani cristallo
8 glass shelves

L W	H H	P D	CODICE CODE
--------	--------	--------	----------------

P 20	60	240	20	DGCT9H31
	75	240	20	DGCT9H41

P 35	60	240	35	DGCT9H32
	75	240	35	DGCT9H42

Materico Textured finish	Lacc. opaco Matt lacq.	Lacc. lucido Glossy lacq.	Essenza Wood	Superfici UP UP surface
-----------------------------	---------------------------	------------------------------	-----------------	----------------------------

1.544	1.698	1.841	1.978	1.883
1.779	1.917	2.063	2.245	2.149

1.719	1.976	2.197	2.434	2.260
1.982	2.230	2.461	2.762	2.577

Indicare in fase d'ordine se inserire la maniglia intera o parziale (inferiore o superiore).
Inclusi piedini regolabili a scomparsa H 1,6 cm. Zoccolo optional H 6 cm (pagina 189).

Indicate full or partial handle (lower or upper) when ordering.
Hidden adjustable feet H 1,6 cm included. Optional plinth H 6 cm (page 189).

ACCESSORI

Accessories

GOLA UP

zoccolo al metro lineare

plinth per linear metre

Finitura di serie alluminio, nero, bianco oppure nelle colorazioni laccato opaco

Standard finishes: aluminium, black or white or coloured matt lacquers

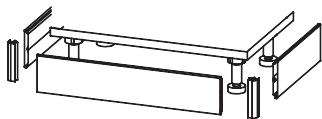

H H	CODICE CODE	Prezzo Price	Lacc. opaco Matt lacq.
6	UZBMZOC6	50	75

6	UZBMZOC6	50	75
---	----------	----	----

sanificatore

sanitizer device

Dispositivo per il trattamento dell'aria con sistema a LED UV. Posizionabile solo su coperchio. Alimentatore incluso. La gestione del posizionamento dell'alimentatore sarà a cura del cliente. Il sistema di accensione deve essere collegato ad un interruttore della rete elettrica della stanza.

Air treatment device with UV LED system, to be placed only on the top panel. Power supply included. Intalling the power supply in the correct positions is the customer's responsibility. The switch-on system must be connected to a main switch in the room.

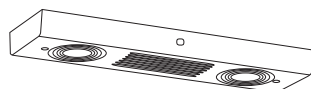

CODICE CODE	Prezzo Price
IRXSA001	215

IRXSA001	215
----------	-----

ripiani portascarpe

shoe shelves

ripiano portascarpe inclinato con lamella in metallo nero per colonne con profondità 35 cm.

inclined shoe shelf with black metal plates for tall units with a depth of 35 cm.

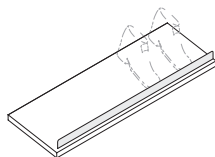

L W	P D	CODICE CODE	Prezzo Price
45	35	DGRR0022	29
60	35	DGRR0032	32
75	35	DGRR0042	34

45	35	DGRR0022	29
60	35	DGRR0032	32
75	35	DGRR0042	34

IDROBOX BASI
IDROBOX BASE UNITS

IDROBOX COLONNE E PENSILI
IDROBOX TALL AND WALL UNITS

IDROBOX ATTREZZATURA
IDROBOX EQUIPMENT

IDROBOX TOP E LAVATOI
IDROBOX TOPS AND WASHBASINS

INGRESSI
HALLWAY CABINETS

SCARPIERE
SHOE CABINETS

ACCESSORI
ACCESSORIES

LED incasso verticale per pensili e colonne

Vertical built-in LED for wall units and tall units

LED incasso verticale esterno o interno su fianco. Alimentatore escluso, da aggiungere in base alla composizione.
External or internal vertical recessed LED on side. Power supply unit excluded; add according to composition.

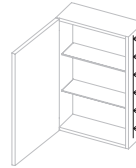

led esterno
external LED

H	Watt	CODICE	Prezzo
H	Watt	CODE	Price

30	4,3	U205071	48
45	6,5	U205072	53
60	8,6	U205073	58
75	10,8	U205074	66
90	13	U205075	72
105	15,1	U205076	79
120	17,3	U205077	86
135	19,4	U205078	96
150	21,6	U205079	102
180	25,9	U20507A	115
195	28,1	U20507B	123
210	30,2	U20507C	130
240	34,6	U20507E	143

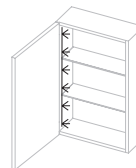

led interno
internal LED

30	4	U205081	54
45	6	U205082	61
60	8,5	U205083	65
75	10,5	U205084	73
90	12,5	U205085	79
105	15	U205086	86
120	17	U205087	93
135	19	U205088	102
150	21,5	U205089	110
180	25,5	U20508A	123
195	27,6	U20508B	129
210	29,7	U20508C	138
240	34,1	U20508E	151

Luce calda 3000 K. Per il calcolo corretto sommare il prezzo delle luci LED nelle misure volute + il prezzo dell'alimentatore adatto.

Attenzione: la gestione del posizionamento dell'alimentatore sarà a cura del cliente. Il sistema di accensione deve essere collegato ad un interruttore della rete elettrica della stanza.

I LED per sponde cassetti hanno alimentatore incluso e non necessitano di collegamento a presa elettrica.

3000 K warm light. To calculate the price, add the cost of the LED lights in the desired sizes and the cost of the relevant power supply unit.

Note: installing the power supply unit in the correct position is the customer's responsibility. The switch-on system must be connected to a mains switch in the room.

Drawer sideboard LEDs come with a power supply unit included and do not require connection to an electrical socket.

LED incasso orizzontale per pensili e colonne

Horizontal built-in LED for wall units and tall units

LED incasso orizzontale solo su coperchio di pensili ribalta e fondo di pensili. Sempre disponibile per pensili e colonne con frontale telaio. Alimentatore escluso, da aggiungere in base alla composizione

Horizontal built-in LED only on top of lift-up door wall units or bottom of wall and units. Always available for wall units and tall units with framed doors. Power supply unit excluded; add according to composition



L W	Watt Watt	CODICE CODE	Prezzo Price
30	4	U205091	48
45	6	U205092	53
60	8,5	U205093	58
75	10,5	U205094	66
90	12,5	U205095	72

LED per sponde cassetti

Drawer sideboard LEDs

LED incasso per sponde Avantechyou Hettich, dotato di batteria al litio ricaricabile e removibile alloggiata sul retro del cassetto.

Built-in LEDs for Hettich Avantech YOU sideboards, equipped with a rechargeable, removable lithium battery housed in the back of the drawer.

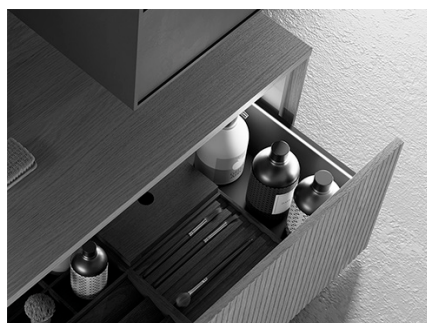

P D	CODICE CODE	Prezzo Price
35	U509021	172
50	U509023	183

Alimentatore

Power supply

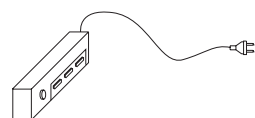

Watt Watt	CODICE CODE	Prezzo Price
15	U509011	37
20	U509012	44
30	U509013	64
50	U509014	70

Luce calda 3000 K. Per il calcolo corretto sommare il prezzo delle luci LED nelle misure volute + il prezzo dell'alimentatore adatto.

Attenzione: la gestione del posizionamento dell'alimentatore sarà a cura del cliente. Il sistema di accensione deve essere collegato ad un interruttore della rete elettrica della stanza.

I LED per sponde cassetti hanno alimentatore incluso e non necessitano di collegamento a presa elettrica.

3000 K warm light. To calculate the price, add the cost of the LED lights in the desired sizes and the cost of the relevant power supply unit.

Note: installing the power supply unit in the correct position is the customer's responsibility. The switch-on system must be connected to a mains switch in the room.

Drawer sideboard LEDs come with a power supply unit included and do not require connection to an electrical socket.

TOP

Tops

GOLA UP

Top al metro lineare sp. 1,8 cm

Top per linear metre 1,8 cm th

L max 270 cm
Max. W 270 cm

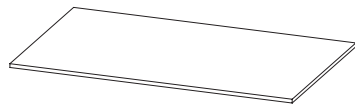

P D	SP TH	CODICE CODE
--------	----------	----------------

20	1,8	U6450101
35	1,8	U6450102
50	1,8	U6450105

Materico Textured finish	Lacc. opaco Matt lacq.	Lacc. lucido Glossy lacq.	Essenza Wood	Superfici UP UP surface
-----------------------------	---------------------------	------------------------------	-----------------	----------------------------

94	133	173	231	199
129	207	277	377	324
165	281	383	525	448

Top in gres al metro lineare sp. 0,6 cm

Stoneware top per linear metre 0,6 cm th

L max 210 cm
Max. W 210 cm

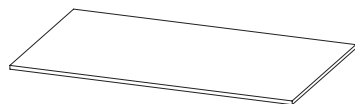

P D	SP TH	CODICE CODE	Gres Stoneware
--------	----------	----------------	-------------------

20	0,6	U6480001	394
35	0,6	U6480002	431
50	0,6	U6480005	555

SKAP

ACCESSORI
ACCESSORIES

SCARPIERE
SHOE CABINETS

INGRESSI
HALLWAY CABINETS

IDROBOX TOP E LAVATOI
IDROBOX TOPS AND WASHBASINS

IDROBOX ATTREZZATURA
IDROBOX EQUIPMENT

IDROBOX COLONNE E PENSILI
IDROBOX TALL AND WALL UNITS

IDROBOX BASI
IDROBOX BASE UNITS

LACCATI OPACHI E LUCIDI | MATT AND GLOSSY LACQUERS

							
9003 Bianco	9010 Panna	9001 Crema	1013 Fior di loto	9002 Ghiaccio	100 Sabbia	63 Tortora	68 Grigio perla
							
71 Light grey	7044 Grigio seta	62 Canapa	61 Corda	72 Dark grey	7039 Grigio aston	101 Giallo senape	173 Bruciato
							
3003 Rosso	3005 Rosso bordeaux	102 Rosa cipria	74 Terracotta	73 Moka	190 Verde pallido	103 Verde malva	104 Turchese
							
105 Oceano	106 Blu cobalto	246 Grigio Garda	107 Celeste	76 Carta da zucchero	7031 Grigio blu	7016 Grigio antracite	9017 Nero
							
Titanio	Nichel	Piombo					

MATERICI | TEXTURED FINISHES

			
Avana	Quarzo	Noce alabama Alabama walnut	Rovere termotrattato Heat-treated oak

SPECCHI | MIRRORS



Specchio
Mirror

La riproduzione dei colori su carta può risultare alterata rispetto agli originali, pertanto queste tinte sono da considerarsi indicative. Laccato a campione/RAL con maggiorazione del 20%.

The reproduction of the colours on paper may be different compared to the original ones, therefore these shades should be considered as representative only. 20% surcharge for custom colour/RALs.

SUPERFICI UP | UP SURFACE

Laccati metallici | Metal effect lacquers



Titanio



Piombo



Nichel



Ossido ottone



Ossido bronzo

Laccati effetto cemento | Concrete effect lacquers



Perla

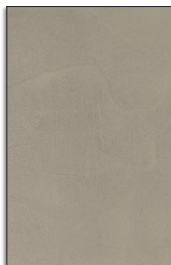

Argilla



Grafite



Lava

ESSENZE | WOOD



Rovere naturale
Natural oak

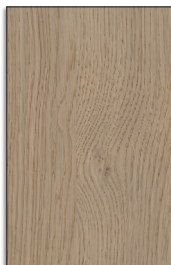

Rovere visone
Visone oak

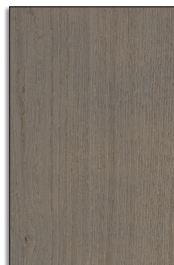

Rovere cenere
Cenere oak



Rovere castoro
Castoro oak



Rovere carbone
Carbone oak



Noce canaletto
Canaletto walnut

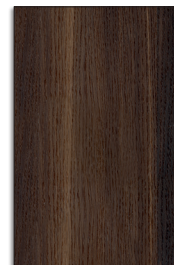

Rovere termotrattato
Heat-treated oak

METALLI | METALS



Bianco
White

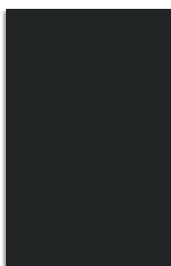

Nero
Black



Titanio
Titanium

IDROBOX BASI
IDROBOX BASE UNITS

IDROBOX COLONNE E PENSILI
IDROBOX TALL AND WALL UNITS

IDROBOX ATTREZZATURA
IDROBOX EQUIPMENT

IDROBOX TOP E LAVATOI
IDROBOX TOPS AND WASHBASINS

INGRESSI
HALLWAY CABINETS

SCARPIERE
SHOE CABINETS

ACCESSORI
ACCESSORIES

SCOCCA STRUCTURE



STRUTTURA: realizzata con pannelli di particelle di legno certificati CARB-2 sp. 25 mm rivestiti con nobilitazione melaminica, laccata o impiallacciata legno e verniciata. Fianchi con foratura passo 96 mm.

SCHIENE: realizzate con pannelli di particelle di legno certificati CARB-2 sp. 18 mm rivestiti con nobilitazione melaminica o laccato. Gli armadi con struttura materico o laccato opaco hanno la schiena nella stessa finitura. Gli armadi con struttura laccato lucido, superfici UP o essenza hanno la schiena materico avana se battenti e laccata opaca in tinta nel caso di ante scorrevoli.

FIANCO TELAIO: realizzato con telaio in alluminio verniciato bianco, nero o titanio sezione 50x25 mm.

STRUCTURE: made of 25 mm th. CARB-2 certified wood particle board panel with melamine coating, lacquered or or wood veneered and varnished. Side panels with holes spaced at 96 mm.

BACKS: made of 18 mm th. CARB-2 certified wood particle board panel with melamine coating or lacquer finish. Wardrobe with textured finish or matt lacquered structure have the back panel in the same finish. Wardrobe with gloss lacquered, UP surface or wood structure, have Avana textured finish backs in the hinged door model and matt lacquered in the same finish in the case of sliding doors.

FRAMED SIDE PANEL: made of white, black or titanium painted aluminum frame 50x25 mm.

FRONTALI FRONTS

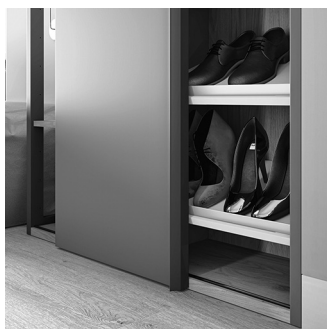

FRONTALI LEGNO: pannelli di particelle di legno certificati CARB-02 sp. 25 mm rivestiti con nobilitazione melaminica, laccati o impiallacciati legno e verniciati

FRONTALI SPECCHIO: specchio sp. 3 mm accoppiato con pannello di particelle di legno sp. 18 mm.

APERTURA: mediante profilo verticale in alluminio verniciato bianco, nero o titanio.

WOODEN FRONTS: 25 mm th. CARB-2 certified wood particle board panel with melamine coating, lacquered or wood veneered and varnished

MIRROR FRONTS: 3 mm thick mirror laminated with 18 mm thick wood particle board.

OPENING: vertical aluminum profile painted white, black or titanium.

ATTREZZATURA EQUIPMENT



RIPIANI PER VANO INTERNO: realizzati in pannelli di particelle di legno sp. 18 mm con nobilitazione melaminica.

RIPIANI PORTASCARPE INCLINATI PER VANO INTERNO: realizzati in pannelli di particelle di legno sp. 18 mm con nobilitazione melaminica inclinati e lamella in metallo nero di supporto alle scarpe

RIPIANI PER VANO ESTERNO: realizzati in pannelli di particelle di legno sp. 18 mm con nobilitazione melaminica, laccati o impiallacciati legno e verniciati.

ELEMENTI A GIORNO PER VANO ESTERNO: realizzati in pannelli di particelle di legno sp. 18 mm con nobilitazione melaminica, laccati o impiallacciati legno e verniciati. Nei moduli in laccato lucido, superfici UP o essenza la schiena è laccata opaca in tinta.

SHELVES FOR INTERIOR COMPARTMENT: made of 18 mm th. wood particle board panel with melamine coating.

INCLINED SHOE RACKS FOR INTERNAL COMPARTMENT: made of 18 mm th. wood particle board panel with melamine coatingh inclined and black metal plates supporting the shoes

SHELVES FOR EXTERNAL COMPARTMENT: made of 18 mm th. wood particle board panel with melamine coating, lacquered or wood veneered and varnished

OPEN ELEMENTS FOR EXTERNAL COMPARTMENT: made of 18 mm thick particle board with melamine finish, lacquered or wood veneer and varnished. In gloss lacquered, UP surfaces or wood modules, the back is matt lacquered to match.

CARATTERISTICHE TECNICHE

Technical features

SKAP

CALCOLO PREZZO ARMADIO BATTENTE

HINGED DOOR WARDROBE PRICE CALCULATION

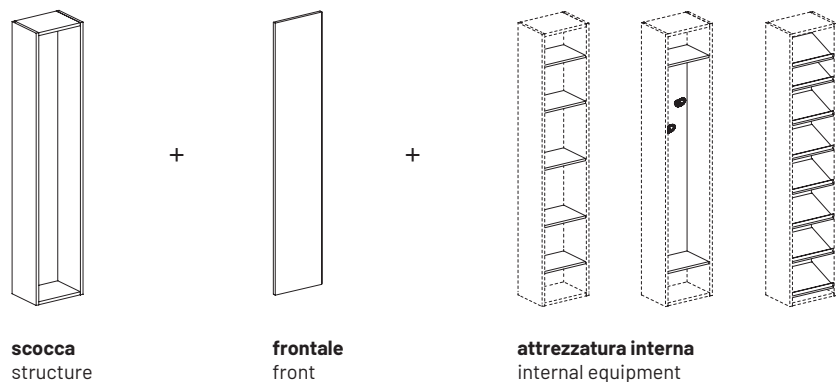

scocca
structure

frontale
front

attrezzatura interna
internal equipment

CALCOLO PREZZO ARMADIO SCORREVOLE

SLIDING DOOR WARDROBE PRICE CALCULATION

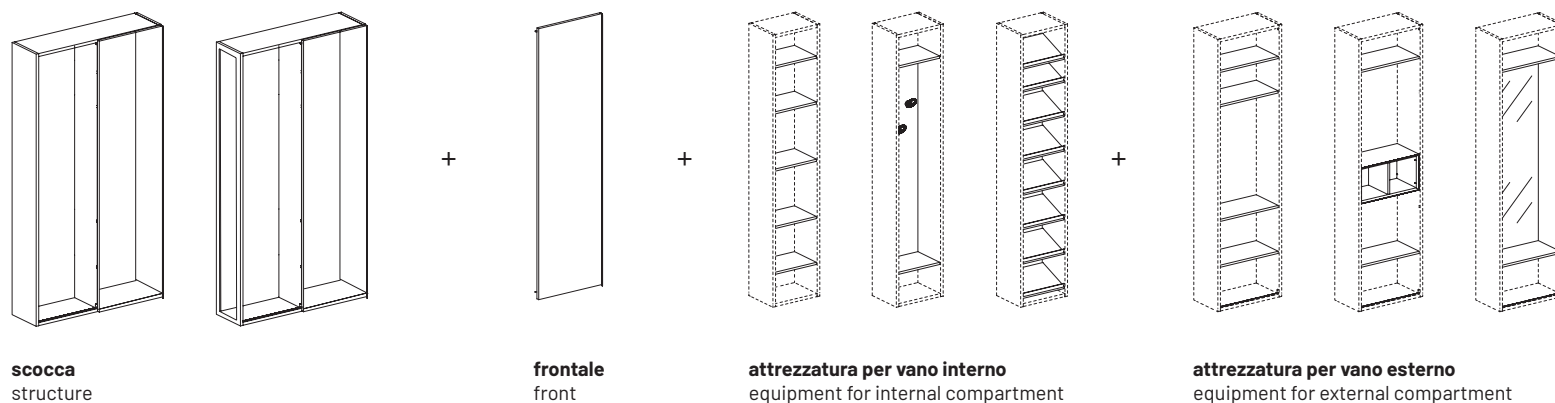

scocca
structure

frontale
front

attrezzatura per vano interno
equipment for internal compartment

attrezzatura per vano esterno
equipment for external compartment

IDROBOX BASI
IDROBOX BASE UNITS

IDROBOX COLONNE E PENSILI
IDROBOX TALL AND WALL UNITS

IDROBOX ATTREZZATURA
IDROBOX EQUIPMENT

IDROBOX TOP E LAVATOI
IDROBOX TOPS AND WASHBASINS

INGRESSI
HALLWAY CABINETS

SCARPIERE
SHOE CABINETS

ACCESSORI
ACCESSORIES

ARMADI CON ANTE BATTENTI H 228,5 cm

Wardrobes with hinged doors h 228,5 cm

SKAP

scocca
structure

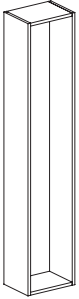

L W	H H	P D	CODICE CODE
--------	--------	--------	----------------

45	228,5	33	SJC0001
60	228,5	33	SJC0002

Materico Textured finish	Lacc. opaco Matt lacq.	Lacc. lucido Glossy lacq.	Essenza Wood	Superfici UP UP surface
-----------------------------	---------------------------	------------------------------	-----------------	----------------------------

438	501	663	717	696
494	566	736	813	772

anta battente
hinged door

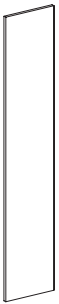

L W	H H	SP TH	CODICE CODE
--------	--------	----------	----------------

44	227	2,5	SJACAB1D
44	227	2,5	SJACAB1S

59	227	2,5	SJACAB2D
59	227	2,5	SJACAB2S

Materico Textured finish	Lacc. opaco Matt lacq.	Lacc. lucido Glossy lacq.	Essenza Wood	Superfici UP UP surface	Specchio Mirror
-----------------------------	---------------------------	------------------------------	-----------------	----------------------------	--------------------

253	350	519	573	546	297
253	350	519	573	546	297

275	364	534	602	561	312
275	364	534	602	561	312

dx | rh

sx | lh

dx | rh

sx | lh

ATTREZZATURA VANO INTERNO BATTENTE

Equipment for interior hinged door compartment

SKAP

n. 5 ripiani per vano interno

5 shelves for internal compartment

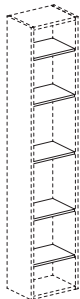

L W	CODICE CODE	Materico Textured finish
40	SJAC001	173
55	SJAC002	196

40	SJAC001	173
55	SJAC002	196

n. 2 ripiani + n. 3 appendini neri per vano interno

2 shelves + 3 black hooks for internal compartment

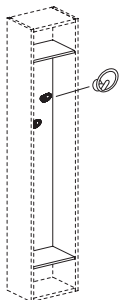

L W	CODICE CODE	Materico Textured finish
40	SJAC003	196
55	SJAC004	200

40	SJAC003	196
55	SJAC004	200

n. 8 ripiani portascarpe per vano interno

8 shoe shelves for internal compartment

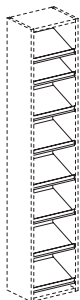

L W	CODICE CODE	Materico Textured finish
40	SJAC005	374
55	SJAC006	477

40	SJAC005	374
55	SJAC006	477

IDROBOX BASI
IDROBOX BASE UNITS

IDROBOX COLONNE E PENSILI
IDROBOX TALL AND WALL UNITS

IDROBOX ATTREZZATURA
IDROBOX EQUIPMENT

IDROBOX TOP E LAVATOI
IDROBOX TOPS AND WASHBASINS

INGRESSI
HALLWAY CABINETS

SCARPIERE
SHOE CABINETS

ACCESSORI
ACCESSORIES

ARMADI CON ANTE SCORREVOLI H 228,5 cm

Wardrobes with sliding doors h 228,5 cm

SKAP

scocca con fianco in legno structure with wooden side

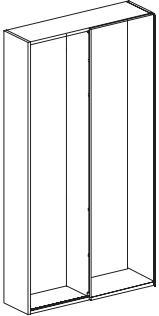

vano a giorno raffigurato sx
open compartment (left shown)

L W	H H	P D	CODICE CODE
--------	--------	--------	----------------

dx rh	105	228,5	35	SJCOL01D
sx lh	105	228,5	35	SJCOL01S

dx rh	120	228,5	35	SJCOL02D
sx lh	120	228,5	35	SJCOL02S

Materico Textured finish	Lacc. opaco Matt lacq.	Lacc. lucido Glossy lacq.	Essenza Wood	Superfici UP UP surface
-----------------------------	---------------------------	------------------------------	-----------------	----------------------------

746	1.359	1.586	1.657	1.666
746	1.359	1.586	1.657	1.666

780	1.428	1.674	1.744	1.758
780	1.428	1.674	1.744	1.758

scocca con fianco telaio structure with framed side

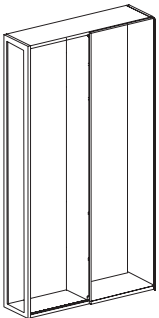

vano a giorno raffigurato sx
open compartment (left shown)

L W	H H	P D	CODICE CODE
--------	--------	--------	----------------

dx rh	105	228,5	35	SJCOM01D
sx lh	105	228,5	35	SJCOM01S

dx rh	120	228,5	35	SJCOM02D
sx lh	120	228,5	35	SJCOM02S

Materico Textured finish	Lacc. opaco Matt lacq.	Lacc. lucido Glossy lacq.	Essenza Wood	Superfici UP UP surface
-----------------------------	---------------------------	------------------------------	-----------------	----------------------------

1.014	1.510	1.662	1.685	1.745
1.014	1.510	1.662	1.685	1.745

1.048	1.586	1.744	1.778	1.832
1.048	1.586	1.744	1.778	1.832

anta scorrevole sliding door

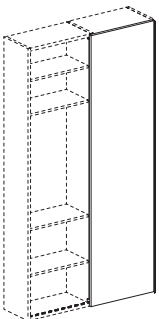

L W	H H	SP TH	CODICE CODE
--------	--------	----------	----------------

51,5	227	2,5	SJACA01
59	227	2,5	SJACA02

Materico Textured finish	Lacc. opaco Matt lacq.	Lacc. lucido Glossy lacq.	Essenza Wood	Superfici UP UP surface	Specchio Mirror
-----------------------------	---------------------------	------------------------------	-----------------	----------------------------	--------------------

253	429	587	617	617	592
265	470	645	674	677	652

ATTREZZATURA VANO ESTERNO SCORREVOLE

Equipment for external sliding door compartment

SKAP

n. 4 ripiani per vano esterno

4 shelves for external compartment

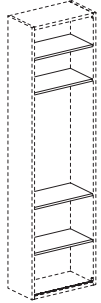

L W	CODICE CODE
--------	----------------

50	SJACE01
57,5	SJACE02

Materico Textured finish	Lacc. opaco Matt lacq.	Lacc. lucido Glossy lacq.	Essenza Wood	Superfici UP UP surface
-----------------------------	---------------------------	------------------------------	-----------------	----------------------------

145	233	233	233	245
153	255	255	255	268

n. 2 ripiani + vano a giorno per vano esterno

2 shelves + open element for external compartment

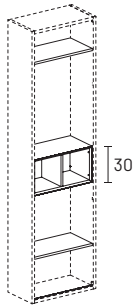

L W	CODICE CODE
--------	----------------

50	SJACE03
57,5	SJACE04

Materico Textured finish	Lacc. opaco Matt lacq.	Lacc. lucido Glossy lacq.	Essenza Wood	Superfici UP UP surface
-----------------------------	---------------------------	------------------------------	-----------------	----------------------------

452	610	610	610	640
470	627	627	627	658

n. 2 ripiani + specchio per vano esterno

2 shelves + mirror for external compartment

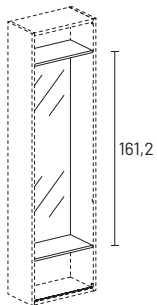

L W	CODICE CODE
--------	----------------

50	SJACE05
57,5	SJACE06

Materico Textured finish	Lacc. opaco Matt lacq.	Lacc. lucido Glossy lacq.	Essenza Wood	Superfici UP UP surface
-----------------------------	---------------------------	------------------------------	-----------------	----------------------------

160	200	200	200	211
179	229	229	229	242

IDROBOX BASI
IDROBOX BASE UNITS

IDROBOX COLONNE E PENSILI
IDROBOX TALL AND WALL UNITS

IDROBOX ATTREZZATURA
IDROBOX EQUIPMENT

IDROBOX TOP E LAVATOI
IDROBOX TOPS AND WASHBASINS

INGRESSI
HALLWAY CABINETS

SCARPIERE
SHOE CABINETS

ACCESSORI
ACCESSORIES

ATTREZZATURA VANO INTERNO SCORREVOLE

Equipment for interior sliding door compartment

SKAP

n. 5 ripiani per vano interno

5 shelves for internal compartment

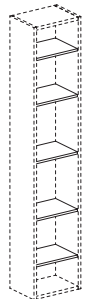

L W	CODICE CODE	Materico Textured finish
--------	-----------------------	------------------------------------

47,5	SJAC021	184
55	SJAC002	196

n. 2 ripiani + n. 3 appendini neri per vano interno

2 shelves + 3 black hooks for internal compartment

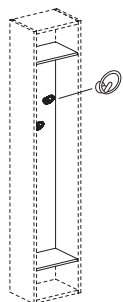

L W	CODICE CODE	Materico Textured finish
--------	-----------------------	------------------------------------

47,5	SJAC023	198
55	SJAC004	200

n. 8 ripiani portascarpe per vano interno

8 shoe shelves for internal compartment

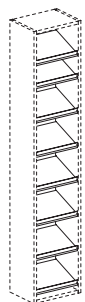

L W	CODICE CODE	Materico Textured finish
--------	-----------------------	------------------------------------

47,5	SJAC025	418
55	SJAC006	477

SCARPIERE

Shoe cabinets

GOLA UP	P. 204
HOSOI	P. 214
LINEAR	P. 220
MINIMA	P. 225
WELCOME	P. 234

CARATTERISTICHE TECNICHE

Technical features

GOLA UP



STRUTTURA: realizzata con pannelli di particelle di legno certificati CARB-2 sp. 18 mm rivestiti con nobilitazione melaminica, laccati o impiallacciati legno e verniciati.

SCHIENE: realizzate con pannelli di particelle di legno certificati CARB-2 sp. 8 mm rivestiti con nobilitazione melaminica avana.

FRONTALI: realizzati con pannelli di particelle di legno certificati CARB-2 sp. 22 mm rivestiti con nobilitazione melaminica, laccati o impiallacciati legno e verniciati. Senso vena orizzontale.

APERTURA: mediante maniglia orizzontale parziale in alluminio disponibile nelle finiture bianco, nero, titanio o laccato opaco con maggiorazione.

ATTREZZATURA: porta scarpe in multistrato di betulla, sostegni in plastica colore antracite. Nelle profondità 26 e 35 cm è possibile rimuovere il ripiano centrale per alloggiare le scarpe con dimensioni maggiori.

BASAMENTO: piedini regolabili a scomparsa H 1,6 cm; piede H 9 cm regolabile in metallo nero, bianco, titanio o laccato opaco; zoccolo H 6 cm in metallo colore alluminio, bianco o nero. Disponibili anche piedi Lama.

TOP: realizzato con pannelli di particelle di legno certificati CARB-2 sp. 18 mm rivestiti con nobilitazione melaminica, laccati o impiallacciati legno e verniciati; disponibile anche in gres sp. 6 mm.

STRUCTURE: made of 18 mm th. CARB-2 certified wood particle board panel with melamine coating, lacquered or wood veneered and varnished.

BACKS: made of 8 mm th. CARB-2 certified wood particle board panel with Avana melamine coating.

FRONTS: made of 22 mm th. CARB-2 certified wood particle board panel with melamine coating, lacquered or wood veneered and varnished. Horizontal grain.

OPENING: partial horizontal aluminum handle available in white, black, titanium or matt lacquer finishes with surcharge.

EQUIPMENT: birch plywood shoe rack, anthracite colour plastic supports. For units depth 26 and 35 cm, the central shelf can be removed to accommodate larger shoes.

BASE: H 1,6 cm concealed adjustable feet; H 9 cm adjustable metal foot in black, white, titanium or matt lacquer; H 6 cm plinth in aluminum, white or black metal colour. Lama foot also available.

TOP: made of 18 mm th. CARB-2 certified wood particle board panel with melamine coating, lacquered or wood veneered and varnished; also available in stoneware 6 mm thick.

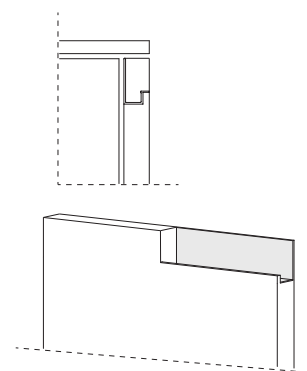

MODULARITÀ MODULARITY

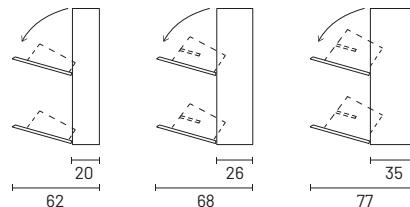
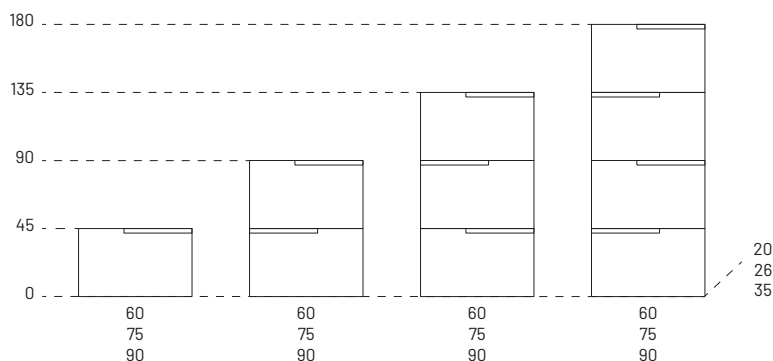

Lavorazioni su misura non disponibili.

Le scarpriere vanno sempre fissate a parete.

La quantità massima di scarpe è calcolata in modo indicativo considerando un assortimento uomo/donna/bambino e tenendo conto che la taglia massima delle scarpe è 45.

Maggiorazione per maniglia nelle finiture laccato opaco: + € 38.

Customization not available.

Shoe racks must always be fixed to the wall.







The maximum number of shoes per cabinet is approximate, considering a combination of men's, women's and children's footwear and taking into account a maximum shoe size of 45.

Surcharge for handle in matt lacquered finishes: + € 38.

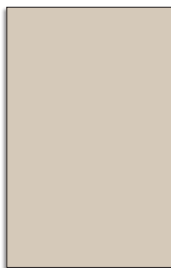
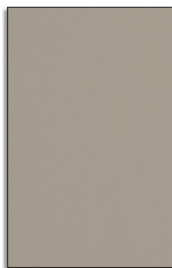
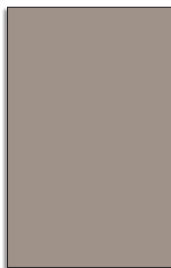
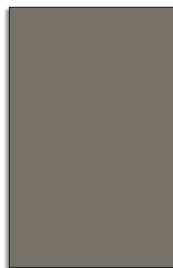
LACCATI OPACHI E LUCIDI | MATT AND GLOSSY LACQUERS

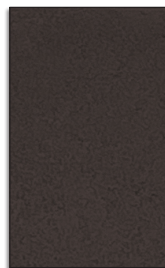
							
9003 Bianco	9010 Panna	9001 Crema	1013 Fior di loto	9002 Ghiaccio	100 Sabbia	63 Tortora	68 Grigio perla
							
71 Light grey	7044 Grigio seta	62 Canapa	61 Corda	72 Dark grey	7039 Grigio aston	101 Giallo senape	173 Bruciato
							
3003 Rosso	3005 Rosso bordeaux	102 Rosa cipria	74 Terracotta	73 Moka	190 Verde pallido	103 Verde malva	104 Turchese
							
105 Oceano	106 Blu cobalto	246 Grigio Garda	107 Celeste	76 Carta da zucchero	7031 Grigio blu	7016 Grigio antracite	9017 Nero
							
Titanio	Nichel	Piombo					

MATERICI | TEXTURED FINISHES

							
Bianco	Sabbia	Avana	Alpaca	Quarzo	Perla	Argilla	Lava
							
Rovere virginia Virginia oak	Noce californiana California walnut	Noce alabama Alabama walnut	Rovere termotrattato Heat-treated oak				

La riproduzione dei colori su carta può risultare alterata rispetto agli originali, pertanto queste tinte sono da considerarsi indicative. Laccato a campione/RAL con maggiorazione del 20%.

The reproduction of the colours on paper may be different compared to the original ones, therefore these shades should be considered as representative only. 20% surcharge for custom colour/RALs.

SUPERFICI UP | UP SURFACE

Laccati metallici | Metal effect lacquers



Titanio



Piombo



Nichel



Ossido ottone



Ossido bronzo

Laccati effetto cemento | Concrete effect lacquers



Perla

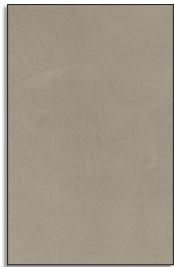

Argilla

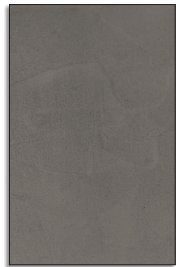

Grafite



Lava

ESSENZE | WOOD



Rovere naturale
Natural oak



Rovere visone
Visone oak

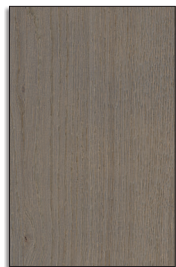

Rovere cenere
Cenere oak



Rovere castoro
Castoro oak



Rovere carbone
Carbone oak



Noce canaletto
Canaletto walnut

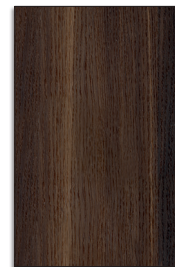

Rovere termotrattato
Heat-treated oak

FINITURE

Finishes

GOLA UP

METALLI | METALS



Bianco
White

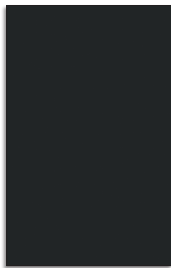

Nero
Black



Titanio
Titanium

GRES | STONEWARE **disponibile solo per top** | available only for tops



Larsen bianco



Pacific bianco



Jasper moka



Iseo grigio



Storm grigio

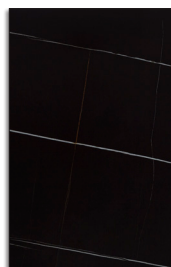

Azalai nero

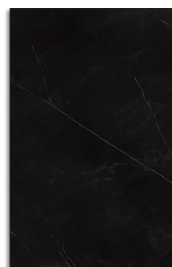

Storm nero



Silver root

IDROBOX BASI
IDROBOX BASE UNITS

IDROBOX COLONNE E PENSILI
IDROBOX TALL AND WALL UNITS

IDROBOX ATTREZZATURA
IDROBOX EQUIPMENT

IDROBOX TOP E LAVATOI
IDROBOX TOPS AND WASHBASINS

INGRESSI
HALLWAY CABINETS

SCARPIERE
SHOE CABINETS

ACCESSORI
ACCESSORIES

MOBILE PORTASCARPE H 45 cm

Shoe units h 45 cm

GOLA UP

1 anta ribalta L 60 cm

1 tilt door W 60 cm



L W	H H	P D	CODICE CODE
--------	--------	--------	----------------

x 2 paia pairs	60	45	20	XLSP1431
-------------------	----	----	----	----------

x 4 paia pairs	60	45	26	XLSP1432
-------------------	----	----	----	----------

x 6 paia pairs	60	45	35	XLSP1433
-------------------	----	----	----	----------

Materico Textured finish	Lacc. opaco Matt lacq.	Lacc. lucido Glossy lacq.	Essenza Wood	Superfici UP UP surface
-----------------------------	---------------------------	------------------------------	-----------------	----------------------------

321	401	463	565	486
-----	-----	-----	-----	-----

339	435	488	594	512
-----	-----	-----	-----	-----

390	535	630	769	661
-----	-----	-----	-----	-----

1 anta ribalta L 75 cm

1 tilt door W 75 cm

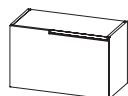

L W	H H	P D	CODICE CODE
--------	--------	--------	----------------

x 3 paia pairs	75	45	20	XLSP1441
-------------------	----	----	----	----------

x 6 paia pairs	75	45	26	XLSP1442
-------------------	----	----	----	----------

x 9 paia pairs	75	45	35	XLSP1443
-------------------	----	----	----	----------

Materico Textured finish	Lacc. opaco Matt lacq.	Lacc. lucido Glossy lacq.	Essenza Wood	Superfici UP UP surface
-----------------------------	---------------------------	------------------------------	-----------------	----------------------------

349	461	537	656	564
-----	-----	-----	-----	-----

385	549	655	800	688
-----	-----	-----	-----	-----

455	618	726	886	763
-----	-----	-----	-----	-----

1 anta ribalta L 90 cm

1 tilt door W 90 cm

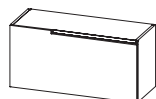

L W	H H	P D	CODICE CODE
--------	--------	--------	----------------

x 4 paia pairs	90	45	20	XLSP1451
-------------------	----	----	----	----------

x 8 paia pairs	90	45	26	XLSP1452
-------------------	----	----	----	----------

x 12 paia pairs	90	45	35	XLSP1453
--------------------	----	----	----	----------

Materico Textured finish	Lacc. opaco Matt lacq.	Lacc. lucido Glossy lacq.	Essenza Wood	Superfici UP UP surface
-----------------------------	---------------------------	------------------------------	-----------------	----------------------------

385	523	615	750	645
-----	-----	-----	-----	-----

423	588	696	850	732
-----	-----	-----	-----	-----

522	684	796	972	836
-----	-----	-----	-----	-----

Specificare se dx o sx (raffigurato dx).
 Aggiungere sempre il top (pagina 213).
 Moduli con predisposizione per fissaggio a parete. Piedi optional.

Specify left or right (right shown).
 Always add the top (page 213).
 Modules can also be wall mounted. Optional feet.

MOBILE PORTASCARPE H 90 cm

Shoe units h 90 cm

GOLA UP

2 ante ribalta L 60 cm

2 W 60 cm tilt doors

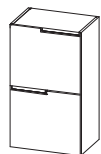

	L W	H H	P D	CODICE CODE	Materico Textured finish	Lacc. opaco Matt lacq.	Lacc. lucido Glossy lacq.	Essenza Wood	Superfici UP UP surface
x 4 paia pairs	60	90	20	XLSP2831	434	565	658	804	691
x 8 paia pairs	60	90	26	XLSP2832	476	630	735	898	772
x 12 paia pairs	60	90	35	XLSP2833	531	727	859	1.049	902

2 ante ribalta L 75 cm

2 W 75 cm tilt doors

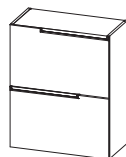

	L W	H H	P D	CODICE CODE	Materico Textured finish	Lacc. opaco Matt lacq.	Lacc. lucido Glossy lacq.	Essenza Wood	Superfici UP UP surface
x 6 paia pairs	75	90	20	XLSP2841	491	661	778	950	816
x 12 paia pairs	75	90	26	XLSP2842	538	752	889	1.087	934
x 18 paia pairs	75	90	35	XLSP2843	656	896	1.055	1.288	1.106

2 ante ribalta L 90 cm

2 W 90 cm tilt doors

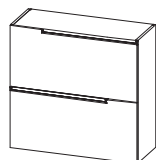

	L W	H H	P D	CODICE CODE	Materico Textured finish	Lacc. opaco Matt lacq.	Lacc. lucido Glossy lacq.	Essenza Wood	Superfici UP UP surface
x 8 paia pairs	90	90	20	XLSP2851	524	736	872	1.066	915
x 16 paia pairs	90	90	26	XLSP2852	601	837	992	1.213	1.043
x 24 paia pairs	90	90	35	XLSP2853	719	967	1.132	1.383	1.190

Specificare se dx o sx (raffigurato dx).
 Aggiungere sempre il top (pagina 213).
 Moduli con predisposizione per fissaggio a parete. Piedi optional.

Specify left or right (right shown).
 Always add the top (page 213).
 Modules can also be wall mounted. Optional feet.

IDROBOX BASI
IDROBOX BASE UNITS

IDROBOX COLONNE E PENSILI
IDROBOX TALL AND WALL UNITS

IDROBOX ATTREZZATURA
IDROBOX EQUIPMENT

IDROBOX TOP E LAVATOI
IDROBOX TOPS AND WASHBASINS

INGRESSI
HALLWAY CABINETS

SCARPIERE
SHOE CABINETS

ACCESSORI
ACCESSORIES

MOBILE PORTASCARPE H 135 cm

Shoe units h 135 cm

GOLA UP

3 ante ribalta L 60 cm

3 W 60 cm tilt doors



L W	H H	P D	CODICE CODE
--------	--------	--------	----------------

x 6 paia pairs	60	135	20	XLSP3B31
-------------------	----	-----	----	----------

x 12 paia pairs	60	135	26	XLSP3B32
--------------------	----	-----	----	----------

x 18 paia pairs	60	135	35	XLSP3B33
--------------------	----	-----	----	----------

Materico Textured finish	Lacc. opaco Matt lacq.	Lacc. lucido Glossy lacq.	Essenza Wood	Superfici UP UP surface
-----------------------------	---------------------------	------------------------------	-----------------	----------------------------

545	728	853	1.042	896
-----	-----	-----	-------	-----

638	850	1.002	1.223	1.052
-----	-----	-------	-------	-------

671	921	1.087	1.327	1.141
-----	-----	-------	-------	-------

3 ante ribalta L 75 cm

3 W 75 cm tilt doors

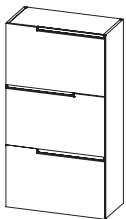

L W	H H	P D	CODICE CODE
--------	--------	--------	----------------

x 9 paia pairs	75	135	20	XLSP3B41
-------------------	----	-----	----	----------

x 18 paia pairs	75	135	26	XLSP3B42
--------------------	----	-----	----	----------

x 27 paia pairs	75	135	35	XLSP3B43
--------------------	----	-----	----	----------

Materico Textured finish	Lacc. opaco Matt lacq.	Lacc. lucido Glossy lacq.	Essenza Wood	Superfici UP UP surface
-----------------------------	---------------------------	------------------------------	-----------------	----------------------------

629	863	1.017	1.242	1.069
-----	-----	-------	-------	-------

693	953	1.126	1.374	1.181
-----	-----	-------	-------	-------

859	1.172	1.381	1.686	1.450
-----	-------	-------	-------	-------

3 ante ribalta L 90 cm

3 W 90 cm tilt doors

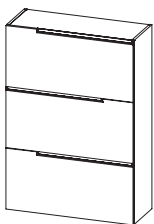

L W	H H	P D	CODICE CODE
--------	--------	--------	----------------

x 12 paia pairs	90	135	20	XLSP3B51
--------------------	----	-----	----	----------

x 24 paia pairs	90	135	26	XLSP3B52
--------------------	----	-----	----	----------

x 36 paia pairs	90	135	35	XLSP3B53
--------------------	----	-----	----	----------

Materico Textured finish	Lacc. opaco Matt lacq.	Lacc. lucido Glossy lacq.	Essenza Wood	Superfici UP UP surface
-----------------------------	---------------------------	------------------------------	-----------------	----------------------------

665	945	1.129	1.379	1.185
-----	-----	-------	-------	-------

779	1.089	1.291	1.577	1.355
-----	-------	-------	-------	-------

916	1.248	1.470	1.797	1.543
-----	-------	-------	-------	-------

Specificare se dx o sx (raffigurato dx).
 Aggiungere sempre il top (pagina 213).
 Moduli con predisposizione per fissaggio a parete. Piedi optional.

Specify left or right (right shown).
 Always add the top (page 213).
 Modules can also be wall mounted. Optional feet.

MOBILE PORTASCARPE H 180 cm

Shoe units h 180 cm

GOLA UP

4 ante ribalta L 60 cm

4 W 60 cm tilt doors

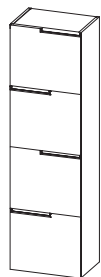

L W	H H	P D	CODICE CODE
--------	--------	--------	----------------

Materico Textured finish	Lacc. opaco Matt lacq.	Lacc. lucido Glossy lacq.	Essenza Wood	Superfici UP UP surface
-----------------------------	---------------------------	------------------------------	-----------------	----------------------------

x 8 paia pairs	60	180	20	XLSP4D31
-------------------	----	-----	----	----------

656	898	1.057	1.291	1.111
-----	-----	-------	-------	-------

x 16 paia pairs	60	180	26	XLSP4D32
--------------------	----	-----	----	----------

771	1.003	1.181	1.442	1.241
-----	-------	-------	-------	-------

x 24 paia pairs	60	180	35	XLSP4D33
--------------------	----	-----	----	----------

825	1.157	1.374	1.679	1.442
-----	-------	-------	-------	-------

4 ante ribalta L 75 cm

4 W 75 cm tilt doors

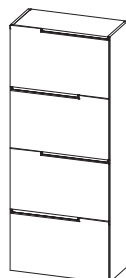

L W	H H	P D	CODICE CODE
--------	--------	--------	----------------

Materico Textured finish	Lacc. opaco Matt lacq.	Lacc. lucido Glossy lacq.	Essenza Wood	Superfici UP UP surface
-----------------------------	---------------------------	------------------------------	-----------------	----------------------------

x 12 paia pairs	75	180	20	XLSP4D41
--------------------	----	-----	----	----------

754	1.104	1.326	1.620	1.393
-----	-------	-------	-------	-------

x 24 paia pairs	75	180	26	XLSP4D42
--------------------	----	-----	----	----------

853	1.185	1.403	1.714	1.473
-----	-------	-------	-------	-------

x 36 paia pairs	75	180	35	XLSP4D43
--------------------	----	-----	----	----------

1.061	1.455	1.716	2.096	1.801
-------	-------	-------	-------	-------

4 ante ribalta L 90 cm

4 W 90 cm tilt doors

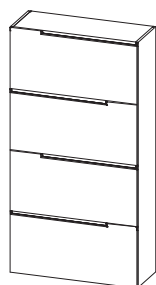

L W	H H	P D	CODICE CODE
--------	--------	--------	----------------

Materico Textured finish	Lacc. opaco Matt lacq.	Lacc. lucido Glossy lacq.	Essenza Wood	Superfici UP UP surface
-----------------------------	---------------------------	------------------------------	-----------------	----------------------------

x 16 paia pairs	90	180	20	XLSP4D51
--------------------	----	-----	----	----------

796	1.157	1.387	1.695	1.455
-----	-------	-------	-------	-------

x 32 paia pairs	90	180	26	XLSP4D52
--------------------	----	-----	----	----------

951	1.342	1.597	1.951	1.677
-----	-------	-------	-------	-------

x 48 paia pairs	90	180	35	XLSP4D53
--------------------	----	-----	----	----------

1.117	1.538	1.813	2.214	1.903
-------	-------	-------	-------	-------

Specificare se dx o sx (raffigurato dx).
 Aggiungere sempre il top (pagina 213).
 Moduli con predisposizione per fissaggio a parete. Piedi optional.

Specify left or right (right shown).
 Always add the top (page 213).
 Modules can also be wall mounted. Optional feet.

IDROBOX BASI
IDROBOX BASE UNITS

IDROBOX COLONNE E PENSILI
IDROBOX TALL AND WALL UNITS

IDROBOX ATTREZZATURA
IDROBOX EQUIPMENT

IDROBOX TOP E LAVATOI
IDROBOX TOPS AND WASHBASINS

INGRESSI
HALLWAY CABINETS

SCARPIERE
SHOE CABINETS

ACCESSORI
ACCESSORIES

ACCESSORI

Accessories

GOLA UP

coppia piedi regolabili H 9 cm

pair of adjustable feet H 9 cm

Finiture bianco, nero, titanio o laccato

White, black, titanium or lacquered finishes



H H	CODICE CODE	Prezzo Price
9	UZ521	46

9	UZ521	46
---	-------	----

coppia piedi Lama H 12 cm

pair of H 12 cm Lama foot

Finiture bianco, nero, titanio

White, black, titanium finishes

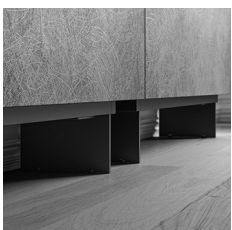

H H	P D	CODICE CODE	Prezzo Price
12	20	UZ524	229
12	35	UZ525	295

12	20	UZ524	229
12	35	UZ525	295

zoccolo al metro lineare

plinth per linear metre

Finitura di serie alluminio, nero, bianco oppure nelle colorazioni laccato opaco

Standard finishes: aluminium, black or white or coloured matt lacquers



H H	CODICE CODE	Prezzo Price	Lacc. opaco Matt lacq.
6	UZBMZOC6	50	75

6	UZBMZOC6	50	75
---	----------	----	----

ACCESSORI

Accessories

GOLA UP

Top al metro lineare sp. 1,8 cm

Top per linear metre 1,8 cm th

L max 270 cm
Max. W 270 cm

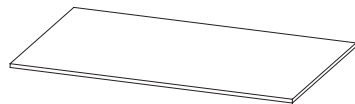

P D	SP TH	CODICE CODE
--------	----------	----------------

20	1,8	U6450101
26	1,8	U645010B
35	1,8	U6450102

Materico Textured finish	Lacc. opaco Matt lacq.	Lacc. lucido Glossy lacq.	Essenza Wood	Superfici UP UP surface
-----------------------------	---------------------------	------------------------------	-----------------	----------------------------

94	133	173	231	199
112	169	225	304	261
129	207	277	377	324

Top in gres al metro lineare sp. 0,6 cm

Stoneware top per linear metre 0,6 cm th

L max 210 cm
Max. W 210 cm

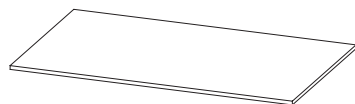

P D	SP TH	CODICE CODE	Gres Stoneware
--------	----------	----------------	-------------------

20	0,6	U6480001	394
26	0,6	U648000B	407
35	0,6	U6480002	431

sanificatore

sanitizer device

Dispositivo per il trattamento dell'aria con sistema a LED UV. Posizionabile solo su coperchio. Alimentatore incluso. La gestione del posizionamento dell'alimentatore sarà a cura del cliente. Il sistema di accensione deve essere collegato ad un interruttore della rete elettrica della stanza.

Air treatment device with UV LED system, to be placed only on the top panel. Power supply included. Intalling the power supply in the correct positions is the customer's responsibility. The swich-on system must be connected to a main switch in the room.

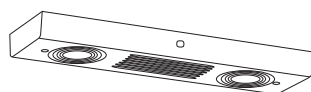

CODICE CODE	Prezzo Price
----------------	-----------------

IRXSA001	215
----------	-----

IDROBOX BASI
IDROBOX BASE UNITS

IDROBOX COLONNE E PENSILI
IDROBOX TALL AND WALL UNITS

IDROBOX ATTREZZATURA
IDROBOX EQUIPMENT

IDROBOX TOP E LAVATOI
IDROBOX TOPS AND WASHBASINS

INGRESSI
HALLWAY CABINETS

SCARPIERE
SHOE CABINETS

ACCESSORI
ACCESSORIES

CARATTERISTICHE TECNICHE

Technical features

HOSOI



STRUTTURA: realizzata con pannelli di particelle di legno certificati CARB-2 sp. 22 mm rivestiti con nobilitazione melaminica o laccati.

SCHIENE: realizzate con pannelli di particelle di legno certificati CARB-2 sp. 8 mm rivestiti con nobilitazione melaminica avana.

FRONTALI: realizzati con pannelli di particelle di legno certificati CARB-2 sp. 22 mm rivestiti con nobilitazione melaminica o laccati. Senso vena orizzontale.

APERTURA: mediante prensilità laterale dell'anta.

ATTREZZATURA: porta scarpe in multistrato di betulla e sostegni in plastica antracite.

BASAMENTO: piede Lama in metallo disponibile nelle finiture nero, bianco o titanio.

TOP: realizzato in vetro trasparente extralight sp. 10 mm oppure in gres sp. 6 mm.

STRUCTURE: made of 22 mm th. CARB-2 certified wood particle board panel with melamine coating or lacquered.

BACKS: made of 8 mm th. CARB-2 certified wood particle board panel with Avana melamine coating.

FRONTS: made of 22 mm th. CARB-2 certified wood particle board panel with melamine coating or lacquered. Horizontal grain.

OPENING: by lateral grip of the door.

EQUIPMENT: shoe rack made of birch plywood and anthracite plastic supports.

BASE: metal Lama foot available in black, white or titanium.

TOP: made of clear extralight glass th 10 mm or stoneware 6 mm.

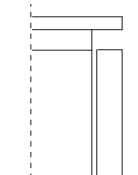
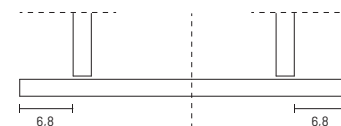

MODULARITÀ MODULARITY

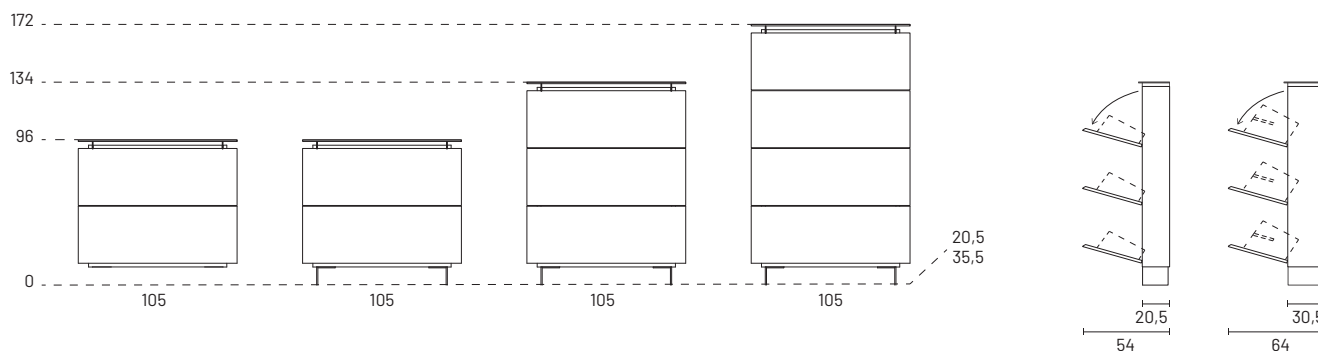

Lavorazioni su misura non disponibili.

Le scarpriere vanno sempre fissate a parete.

La quantità massima di scarpe è calcolata in modo indicativo considerando un assortimento uomo/donna/bambino e tenendo conto che la taglia massima delle scarpe è 45.

Customization not available.





Shoe racks must always be fixed to the wall.

The maximum number of shoes per cabinet is approximate, considering a combination of men's, women's and children's footwear and taking into account a maximum shoe size of 45.

LACCATI OPACHI E LUCIDI | MATT AND GLOSSY LACQUERS

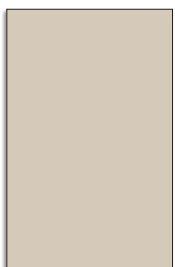
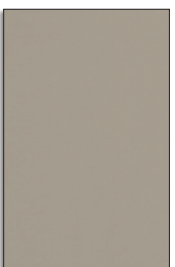
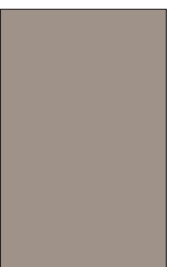
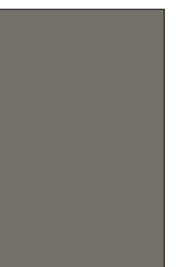
							
9003 Bianco	9010 Panna	9001 Crema	1013 Fior di loto	9002 Ghiaccio	100 Sabbia	63 Tortora	68 Grigio perla
							
71 Light grey	7044 Grigio seta	62 Canapa	61 Corda	72 Dark grey	7039 Grigio aston	101 Giallo senape	173 Bruciato
							
3003 Rosso	3005 Rosso bordeaux	102 Rosa cipria	74 Terracotta	73 Moka	190 Verde pallido	103 Verde malva	104 Turchese
							
105 Oceano	106 Blu cobalto	246 Grigio Garda	107 Celeste	76 Carta da zucchero	7031 Grigio blu	7016 Grigio antracite	9017 Nero
							
Titanio	Nichel	Piombo					

MATERICI | TEXTURED FINISHES

							
Bianco	Sabbia	Avana	Alpaca	Quarzo	Perla	Argilla	Lava

			
Rovere virginia Virginia oak	Noce californiana California walnut	Noce alabama Alabama walnut	Rovere termotrattato Heat-treated oak

La riproduzione dei colori su carta può risultare alterata rispetto agli originali, pertanto queste tinte sono da considerarsi indicative. Laccato a campione/RAL con maggiorazione del 20%.

The reproduction of the colours on paper may be different compared to the original ones, therefore these shades should be considered as representative only. 20% surcharge for custom colour/RALs.

SUPERFICI UP | UP SURFACE

Laccati metallici | Metal effect lacquers



Titanio

Piombo

Nichel

Ossido ottone

Ossido bronzo

Laccati effetto cemento | Concrete effect lacquers

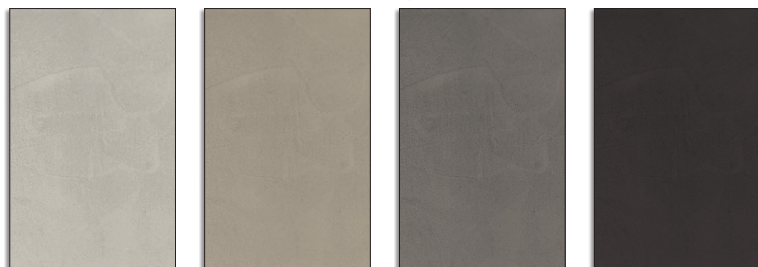

Perla

Argilla

Grafite

Lava

METALLI | METALS

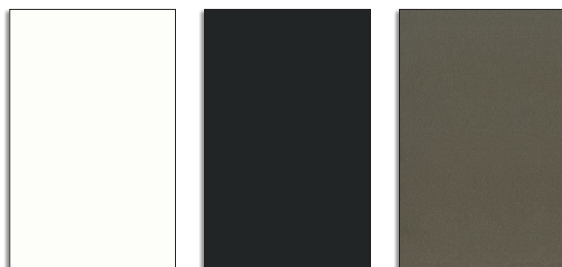

Bianco
White

Nero
Black

Titanio
Titanium

FINITURE

Finishes

HOSOI

VETRO | GLASS disponibile solo per top | available only for top



Trasparente extralight

Clear extralight

GRES | STONEWARE disponibile solo per top | available only for tops



Larsen bianco



Pacific bianco



Jasper moka



Iseo grigio



Storm grigio

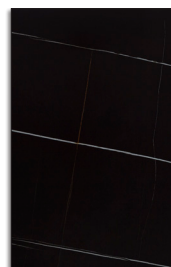

Azalai nero

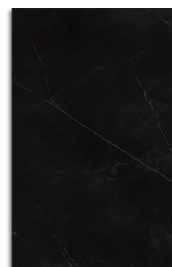

Storm nero



Silver root

IDROBOX BASI
IDROBOX BASE UNITS

IDROBOX COLONNE E PENSILI
IDROBOX TALL AND WALL UNITS

IDROBOX ATTREZZATURA
IDROBOX EQUIPMENT

IDROBOX TOP E LAVATOI
IDROBOX TOPS AND WASHBASINS

INGRESSI
HALLWAY CABINETS

SCARPIERE
SHOE CABINETS

ACCESSORI
ACCESSORIES

MOBILE PORTASCARPE

Shoe units

HOSOI

2 ante ribalta

2 tilt doors

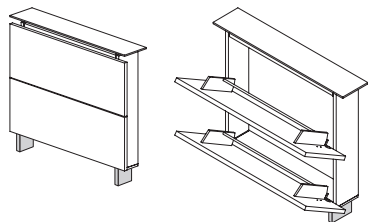

piede H 12 cm incluso
foot H 12 cm included

L W	H H	P D	CODICE CODE
--------	--------	--------	----------------

x 6 paia
pairs

105	96	20,5	HS0961
-----	----	------	--------

x 12 paia
pairs

105	96	30,5	HS0962
-----	----	------	--------

Materico Textured finish	Lacc. opaco Matt lacq.	Lacc. lucido Glossy lacq.	Superfici UP UP surface
-----------------------------	---------------------------	------------------------------	----------------------------

977	1.128	1.303	1.368
-----	-------	-------	-------

1.147	1.307	1.481	1.555
-------	-------	-------	-------

2 ante ribalta sospeso

2 tilt doors suspended

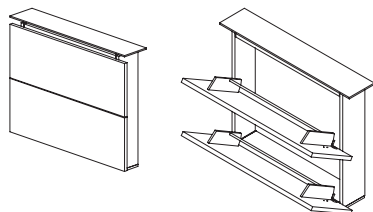

L W	H H	P D	CODICE CODE
--------	--------	--------	----------------

x 6 paia
pairs

105	84	20,5	HI0961S
-----	----	------	---------

x 12 paia
pairs

105	84	30,5	HI0962S
-----	----	------	---------

Materico Textured finish	Lacc. opaco Matt lacq.	Lacc. lucido Glossy lacq.	Superfici UP UP surface
-----------------------------	---------------------------	------------------------------	----------------------------

674	810	989	1.038
-----	-----	-----	-------

758	898	1.075	1.130
-----	-----	-------	-------

Di serie con top in cristallo extralight.

Maggiorazione per top in gres:

P 20,5 cm: € 182

P 30,5 cm: € 213

Standard with extralight glass top.

Surcharge for stoneware top:

D 20,5 cm: € 182

D 30,5 cm: € 213

MOBILE PORTASCARPE

Shoe units

HOSOI

3 ante ribalta

3 tilt doors

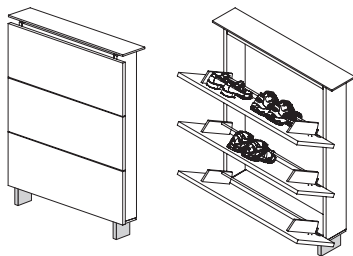

piede H 12 cm incluso
foot H 12 cm included

4 ante ribalta

4 tilt doors

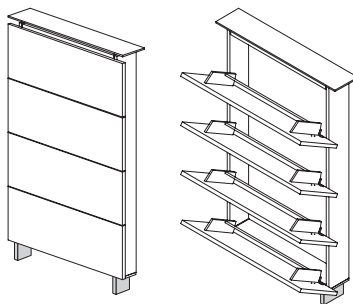

piede H 12 cm incluso
foot H 12 cm included

sanificatore

sanitizer device

Dispositivo per il trattamento dell'aria con sistema a LED UV. Posizionabile solo su coperchio. Alimentatore incluso. La gestione del posizionamento dell'alimentatore sarà a cura del cliente. Il sistema di accensione deve essere collegato ad un interruttore della rete elettrica della stanza.

Air treatment device with UV LED system, to be placed only on the top panel. Power supply included. Intalling the power supply in the correct positions is the customer's responsibility. The swich-on system must be connected to a main switch in the room.

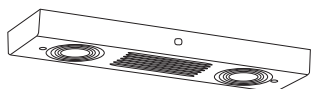

Di serie con top in cristallo extralight.

Maggiorazione per top in gres:

P 20,5 cm: € 182

P 30,5 cm: € 213

Standard with extralight glass top.

Surcharge for stoneware top:

D 20,5 cm: € 182

D 30,5 cm: € 213

	L W	H H	P D	CODICE CODE
--	--------	--------	--------	----------------

x 9 paia
pairs

105	134	20,5	HI1341
-----	-----	------	--------

x 18 paia
pairs

105	134	30,5	HI1342
-----	-----	------	--------

Materico Textured finish	Lacc. opaco Matt lacq.	Lacc. lucido Glossy lacq.	Superfici UP UP surface
-----------------------------	---------------------------	------------------------------	----------------------------

1.237	1.421	1.663	1.746
-------	-------	-------	-------

1.434	1.630	1.871	1.964
-------	-------	-------	-------

L W	H H	P D	CODICE CODE
--------	--------	--------	----------------

x 12 paia
pairs

105	172	20,5	HI1721
-----	-----	------	--------

x 24 paia
pairs

105	172	30,5	HI1722
-----	-----	------	--------

Materico Textured finish	Lacc. opaco Matt lacq.	Lacc. lucido Glossy lacq.	Superfici UP UP surface
-----------------------------	---------------------------	------------------------------	----------------------------

1.508	1.723	2.050	2.152
-------	-------	-------	-------

1.776	2.006	2.331	2.448
-------	-------	-------	-------

CODICE
CODE

Prezzo
Price

IRXSA001

215

IDROBOX BASI
IDROBOX BASE UNITS

IDROBOX COLONNE E PENSILI
IDROBOX TALL AND WALL UNITS

IDROBOX ATTREZZATURA
IDROBOX EQUIPMENT

IDROBOX TOP E LAVATOI
IDROBOX TOPS AND WASHBASINS

INGRESSI
HALLWAY CABINETS

SCARPIERE
SHOE CABINETS

ACCESSORI
ACCESSORIES

CARATTERISTICHE TECNICHE

Technical features

LINEAR



STRUTTURA: realizzata con pannelli di particelle di legno certificati CARB-2 sp. 18 mm rivestiti con nobilitazione melaminica o laccato. Fianchi con foratura passo 32 mm.

SCHIENE: realizzate con pannelli di particelle di legno certificati CARB-2 sp. 8 mm rivestiti con nobilitazione melaminica.

FRONTALI: realizzati con pannelli di particelle di legno certificati CARB-2 sp. 18 mm rivestiti con nobilitazione melaminica, laccati o accoppiati con specchio.

APERTURA: mediante maniglia orizzontale in legno laccata.

ATTREZZATURA: ripiani e fasce interno anta in multistrato di betulla, sostegni in plastica colore antracite.

BASAMENTO: piede H 9 cm regolabile in metallo nero, bianco, titanio o laccato opaco.

STRUCTURE: made of 18 mm th. CARB-2 certified wood particle board panel with melamine coating or lacquered. Side panels with hole spaced at 32 mm.

BACKS: made of 8 mm th. CARB-2 certified wood particle board panel with melamine coating.

FRONTS: made of 18 mm th. CARB-2 certified wood particle board panel with melamine coating, lacquered or laminated with mirror.

OPENING: horizontal lacquered wooden handle.

EQUIPMENT: birch plywood shelves and inner door side, anthracite plastic supports.

BASEMENT: H 9 cm adjustable metal foot in black, white, titanium or matt lacquered.

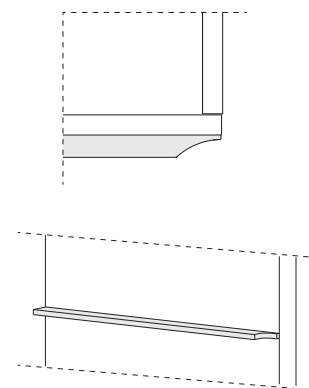

MODULARITÀ MODULARITY

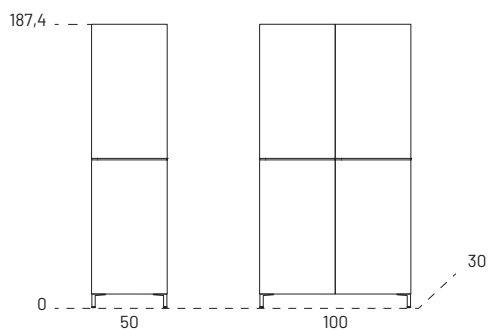



Lavorazioni su misura non disponibili.
Le scarpriere vanno sempre fissate a parete.
La quantità massima di scarpe è calcolata in modo indicativo considerando un assortimento uomo/donna/bambino e tenendo conto che la taglia massima delle scarpe è 45.

Customization not available.
Shoe racks must always be fixed to the wall.
The maximum number of shoes per cabinet is approximate, considering a combination of men's, women's and children's footwear and taking into account a maximum shoe size of 45.

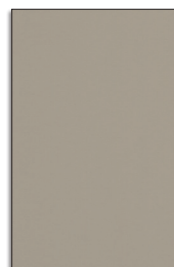
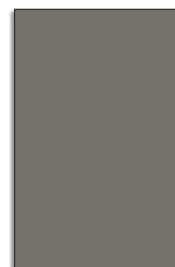

LACCATI OPACHI E LUCIDI | MATT AND GLOSSY LACQUERS

							
9003 Bianco	9010 Panna	9001 Crema	1013 Fior di loto	9002 Ghiaccio	100 Sabbia	63 Tortora	68 Grigio perla
							
71 Light grey	7044 Grigio seta	62 Canapa	61 Corda	72 Dark grey	7039 Grigio aston	101 Giallo senape	173 Bruciato
							
3003 Rosso	3005 Rosso bordeaux	102 Rosa cipria	74 Terracotta	73 Moka	190 Verde pallido	103 Verde malva	104 Turchese
							
105 Oceano	106 Blu cobalto	246 Grigio Garda	107 Celeste	76 Carta da zucchero	7031 Grigio blu	7016 Grigio antracite	9017 Nero
							
Titanio	Nichel	Piombo					

MATERICI | TEXTURED FINISHES

				
Bianco	Avana	Quarzo	Perla	Argilla

SPECCHI | MIRRORS

		
Specchio Mirror	Specchio fumo Smoked mirror	Specchio bronzo Bronze mirror

La riproduzione dei colori su carta può risultare alterata rispetto agli originali, pertanto queste tinte sono da considerarsi indicative. Laccato a campione/RAL con maggiorazione del 20%.

The reproduction of the colours on paper may be different compared to the original ones, therefore these shades should be considered as representative only. 20% surcharge for custom colour/RALs.

SUPERFICI UP | UP SURFACE

Laccati metallici | Metal effect lacquers



Titanio

Piombo

Nichel

Ossido ottone

Ossido bronzo

Laccati effetto cemento | Concrete effect lacquers

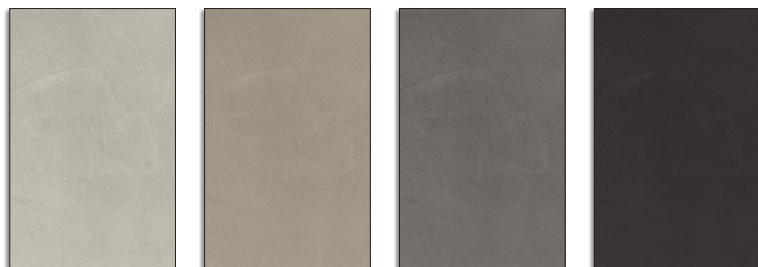

Perla

Argilla

Grafite

Lava

METALLI | METALS

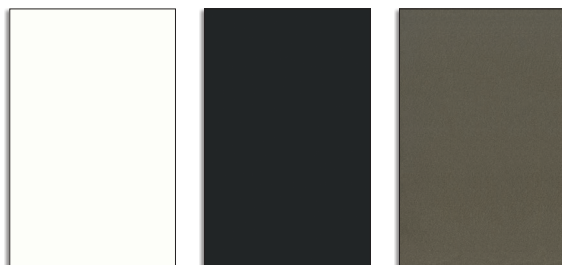

Bianco
White

Nero
Black

Titanio
Titanium

MOBILE PORTASCARPE H 187,4 cm

Shoe units h 187,4 cm

LINEAR

1 anta battente

1 hinged door

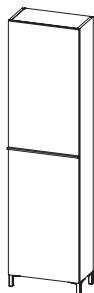

piede H 9 cm incluso

H 9 cm foot included

x 20 paia
pairs

L W	H H	P D	CODICE CODE
50	187,4	30	LN1A050D
50	187,4	30	LN1A050S

Materico Textured finish	Lacc. opaco Matt lacq	Lacc. lucido Glossy lacq.	Superfici UP UP surface
739	1.164	1.543	1.622
739	1.164	1.543	1.622

1 anta battente specchio

1 mirror hinged door

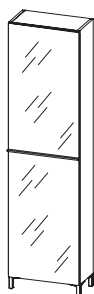

piede H 9 cm incluso

H 9 cm foot included

specchio
mirror

x 20 paia
pairs

L W	H H	P D	CODICE CODE
50	187,4	30	LN1S050D
50	187,4	30	LN1S050S

Materico Textured finish	Lacc. opaco Matt lacq	Lacc. lucido Glossy lacq.	Superfici UP UP surface
796	1.095	1.441	1.514
796	1.095	1.441	1.514

specchio fumo/bronzo
smoked/bronze mirror

x 20 paia
pairs

L W	H H	P D	CODICE CODE
50	187,4	30	LN1S050D
50	187,4	30	LN1S050S

Materico Textured finish	Lacc. opaco Matt lacq	Lacc. lucido Glossy lacq.	Superfici UP UP surface
843	1.143	1.488	1.563
843	1.143	1.488	1.563

IDROBOX BASI
IDROBOX BASE UNITS

IDROBOX COLONNE E PENSILI
IDROBOX TALL AND WALL UNITS

IDROBOX ATTREZZATURA
IDROBOX EQUIPMENT

IDROBOX TOP E LAVATOI
IDROBOX TOPS AND WASHBASINS

INGRESSI
HALLWAY CABINETS

SCARPIERE
SHOE CABINETS

ACCESSORI
ACCESSORIES

MOBILE PORTASCARPE H 187,4 cm

Shoe units h 187,4 cm

LINEAR

2 ante battenti

2 hinged doors

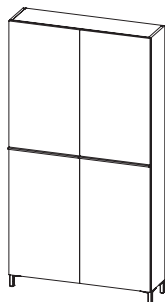

piede H 9 cm incluso
H 9 cm foot included

L W	H H	P D	CODICE CODE
--------	--------	--------	----------------

x 40 paia
pairs

100	187,4	30	LN1A100
-----	-------	----	---------

Materico Textured finish	Lacc. opaco Matt lacq	Lacc. lucido Glossy lacq.	Superfici UP UP surface
-----------------------------	--------------------------	------------------------------	----------------------------

1.117	1.584	1.830	1.922
-------	-------	-------	-------

2 ante battenti specchio

2 mirror hinged doors

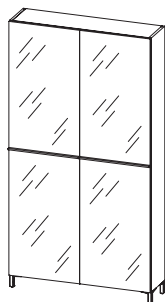

piede H 9 cm incluso
H 9 cm foot included

L W	H H	P D	CODICE CODE
--------	--------	--------	----------------

x 40 paia
pairs

100	187,4	30	LN1S100
-----	-------	----	---------

Materico Textured finish	Lacc. opaco Matt lacq	Lacc. lucido Glossy lacq.	Superfici UP UP surface
-----------------------------	--------------------------	------------------------------	----------------------------

1.261	1.684	1.852	1.946
-------	-------	-------	-------

specchio
mirror
specchio fumo/bronz
smoked/bronze mirror

x 40 paia
pairs

100	187,4	30	LN1S100
-----	-------	----	---------

1.342	1.766	1.934	2.031
-------	-------	-------	-------

sanificatore

sanitizer device

Dispositivo per il trattamento dell'aria con sistema a LED UV. Posizionabile solo su coperchio. Alimentatore incluso. La gestione del posizionamento dell'alimentatore sarà a cura del cliente. Il sistema di accensione deve essere collegato ad un interruttore della rete elettrica della stanza.
Air treatment device with UV LED system, to be placed only on the top panel. Power supply included. Intalling the power supply in the correct positions is the customer's responsibility. The swich-on system must be connected to a main switch in the room.

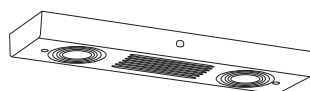

CODICE CODE	Prezzo Price
----------------	-----------------

IRXSA001	215
----------	-----

CARATTERISTICHE TECNICHE

Technical features

MINIMA



STRUTTURA: realizzata con pannelli di particelle di legno certificati CARB-2 sp. 18 mm rivestiti con nobilitazione melaminica o laccati.

SCHIENE: realizzate con pannelli di particelle di legno certificati CARB-2 sp. 8 mm rivestiti con nobilitazione melaminica.

FRONTALI: realizzati con pannelli di particelle di legno certificati CARB-2 sp. 18 mm rivestiti con nobilitazione melaminica o laccati.

APERTURA: mediante maniglia orizzontale in alluminio disponibile nelle finiture bianco, nero, titanio o laccato opaco con maggiorazione.

ATTREZZATURA: porta scarpe in multistrato di betulla, sostegni in plastica colore antracite. Nelle profondità 26 e 35 cm è possibile rimuovere il ripiano centrale per alloggiare le scarpe con dimensioni maggiori.

BASAMENTO: piedini regolabili a scomparsa H 1,6 cm; piede H 9 cm regolabile in metallo nero, bianco, titanio o laccato opaco; zoccolo H 6 cm in metallo colore alluminio, bianco o nero. Disponibili anche piedi Lama.

TOP: realizzato con pannelli di particelle di legno certificati CARB-2 sp. 18 mm rivestiti con nobilitazione melaminica o laccato.

STRUCTURE: made of 18 mm th. CARB-2 certified wood particle board panel with melamine coating or lacquered.

BACKS: made of 8 mm th. CARB-2 certified wood particle board panel with melamine coating.

FRONTS: made of 18 mm th. CARB-2 certified wood particle board panel with melamine coating or lacquered.

OPENING: horizontal aluminum handle available in white, black, titanium or matt lacquer finishes with surcharge.

EQUIPMENT: birch plywood shoe rack, anthracite colour plastic supports. For units depth 26 and 35 cm, the central shelf can be removed to accommodate larger shoes.

BASE: H 1,6 cm concealed adjustable feet; H 9 cm adjustable metal foot in black, white, titanium or matt lacquer; H 6 cm plinth in aluminum, white or black metal colour. Lama foot also available.

TOP: made of 18 mm th. CARB-2 certified wood particle board panel with melamine coating or lacquered.

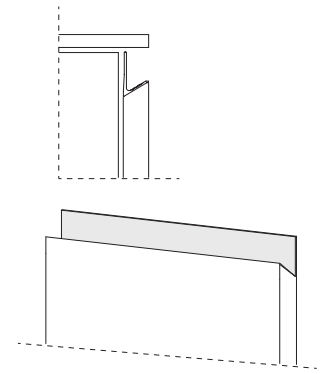

MODULARITÀ MODULARITY

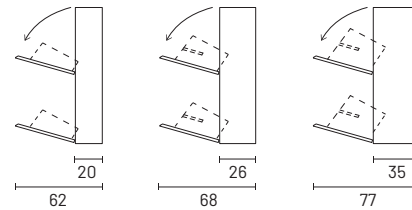
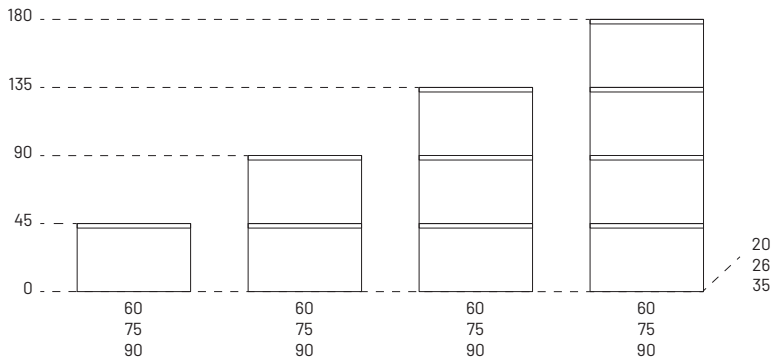

Lavorazioni su misura disponibili solo per riduzioni in larghezza.

Le scarpiere vanno sempre fissate a parete.

La quantità massima di scarpe è calcolata in modo indicativo considerando un assortimento uomo/donna/bambino e tenendo conto che la taglia massima delle scarpe è 45.

Maggiorazione per maniglia nelle finiture laccato opaco: + €38

Customization available only for width reduction.

Shoe racks must always be fixed to the wall.

The maximum number of shoes per cabinet is approximate, considering a combination of men's, women's and children's footwear and taking into account a maximum shoe size of 45.

Surcharge for handle in matt lacquered finishes: + €38

IDROBOX BASI
IDROBOX BASE UNITS

IDROBOX COLONNE E PENSILI
IDROBOX TALL AND WALL UNITS

IDROBOX ATTREZZATURA
IDROBOX EQUIPMENT

IDROBOX TOP E LAVATOI
IDROBOX TOPS AND WASHBASINS

INGRESSI
HALLWAY CABINETS







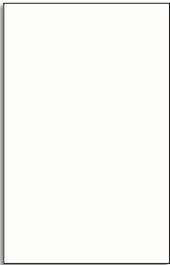

SCARPIERE
SHOE CABINETS

ACCESSORI
ACCESSORIES

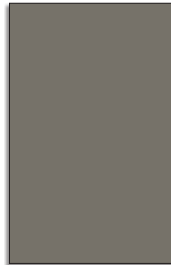
LACCATI OPACHI E LUCIDI | MATT AND GLOSSY LACQUERS

							
9003 Bianco	9010 Panna	9001 Crema	1013 Fior di loto	9002 Ghiaccio	100 Sabbia	63 Tortora	68 Grigio perla
							
71 Light grey	7044 Grigio seta	62 Canapa	61 Corda	72 Dark grey	7039 Grigio aston	101 Giallo senape	173 Bruciato
							
3003 Rosso	3005 Rosso bordeaux	102 Rosa cipria	74 Terracotta	73 Moka	190 Verde pallido	103 Verde malva	104 Turchese
							
105 Oceano	106 Blu cobalto	246 Grigio Garda	107 Celeste	76 Carta da zucchero	7031 Grigio blu	7016 Grigio antracite	9017 Nero
							
Titanio	Nichel	Piombo					

MATERICI | TEXTURED FINISHES

							
Bianco	Avana	Quarzo	Perla	Argilla	Rovere virginia Virginia oak	Noce alabama Alabama walnut	Rovere termotrattato Heat-treated oak

La riproduzione dei colori su carta può risultare alterata rispetto agli originali, pertanto queste tinte sono da considerarsi indicative. Laccato a campione/RAL con maggiorazione del 20%.

The reproduction of the colours on paper may be different compared to the original ones, therefore these shades should be considered as representative only. 20% surcharge for custom colour/RALs.

FINITURE

Finishes

MINIMA

SUPERFICI UP | UP SURFACE

Laccati metallici | Metal effect lacquers



Titanio



Piombo



Nichel



Ossido ottone



Ossido bronzo

Laccati effetto cemento | Concrete effect lacquers



Perla

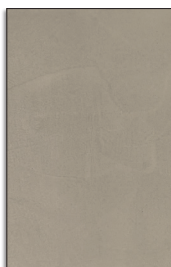

Argilla



Grafite



Lava

METALLI | METALS



Bianco
White

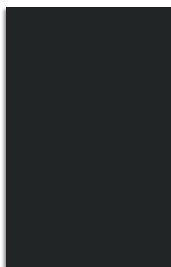

Nero
Black



Titanio
Titanium

IDROBOX BASI
IDROBOX BASE UNITS

IDROBOX COLONNE E PENSILI
IDROBOX TALL AND WALL UNITS

IDROBOX ATTREZZATURA
IDROBOX EQUIPMENT

IDROBOX TOP E LAVATOI
IDROBOX TOPS AND WASHBASINS

INGRESSI
HALLWAY CABINETS

SCARPIERE
SHOE CABINETS

ACCESSORI
ACCESSORIES

MOBILE PORTASCARPE H 45 cm

Shoe units h 45 cm

MINIMA

1 anta ribalta L 60 cm

1 tilt door W 60 cm



L W	H H	P D	CODICE CODE
--------	--------	--------	----------------

Materico Textured finish	Lacc. opaco Matt lacq.	Lacc. lucido Glossy lacq.	Superfici UP UP surface
-----------------------------	---------------------------	------------------------------	----------------------------

x 2 paia
pairs

60	45	20	MISP1431
----	----	----	----------

312	386	442	464
-----	-----	-----	-----

x 4 paia
pairs

60	45	26	MISP1432
----	----	----	----------

329	420	472	495
-----	-----	-----	-----

x 6 paia
pairs

60	45	35	MISP1433
----	----	----	----------

374	508	600	629
-----	-----	-----	-----

1 anta ribalta L 75 cm

1 tilt door W 75 cm

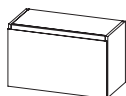

L W	H H	P D	CODICE CODE
--------	--------	--------	----------------

Materico Textured finish	Lacc. opaco Matt lacq.	Lacc. lucido Glossy lacq.	Superfici UP UP surface
-----------------------------	---------------------------	------------------------------	----------------------------

x 3 paia
pairs

75	45	20	MISP1441
----	----	----	----------

341	443	512	537
-----	-----	-----	-----

x 6 paia
pairs

75	45	26	MISP1442
----	----	----	----------

373	528	626	656
-----	-----	-----	-----

x 9 paia
pairs

75	45	35	MISP1443
----	----	----	----------

436	590	694	728
-----	-----	-----	-----

1 anta ribalta L 90 cm

1 tilt door W 90 cm



L W	H H	P D	CODICE CODE
--------	--------	--------	----------------

Materico Textured finish	Lacc. opaco Matt lacq.	Lacc. lucido Glossy lacq.	Superfici UP UP surface
-----------------------------	---------------------------	------------------------------	----------------------------

x 4 paia
pairs

90	45	20	MISP1451
----	----	----	----------

376	505	592	621
-----	-----	-----	-----

x 8 paia
pairs

90	45	26	MISP1452
----	----	----	----------

412	563	668	702
-----	-----	-----	-----

x 12 paia
pairs

90	45	35	MISP1453
----	----	----	----------

512	674	782	821
-----	-----	-----	-----

Aggiungere sempre il top (pagina 233).

Moduli con predisposizione per fissaggio a parete. Piedi optional.

Maggiorazione (a frontale) per riduzione in larghezza:

P 20 / 26 cm € 211

P 35 cm € 444.

Always add the top (page 233).

Modules can also be wall mounted. Optional feet.

Surcharge (per front) for width reduction:

D 20 / 26 cm € 211

D 35 cm € 444.

MOBILE PORTASCARPE H 90 cm

Shoe units h 90 cm

MINIMA

2 ante ribalta L 60 cm

2 W 60 cm tilt doors

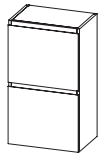

2 ante ribalta L 75 cm

2 W 75 cm tilt doors

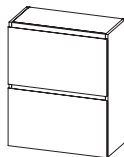

2 ante ribalta L 90 cm

2 W 90 cm tilt doors

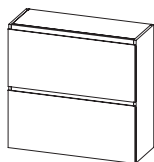

L W	H H	P D	CODICE CODE
--------	--------	--------	----------------

x 4 paia pairs	60	90	20	MISP2831
-------------------	----	----	----	----------

x 8 paia pairs	60	90	26	MISP2832
-------------------	----	----	----	----------

x 12 paia pairs	60	90	35	MISP2833
--------------------	----	----	----	----------

Materico Textured finish	Lacc. opaco Matt lacq.	Lacc. lucido Glossy lacq.	Superfici UP UP surface
-----------------------------	---------------------------	------------------------------	----------------------------

425	548	633	665
-----	-----	-----	-----

493	665	780	819
-----	-----	-----	-----

517	699	822	863
-----	-----	-----	-----

L W	H H	P D	CODICE CODE
--------	--------	--------	----------------

x 6 paia pairs	75	90	20	MISP2841
-------------------	----	----	----	----------

x 12 paia pairs	75	90	26	MISP2842
--------------------	----	----	----	----------

x 18 paia pairs	75	90	35	MISP2843
--------------------	----	----	----	----------

Materico Textured finish	Lacc. opaco Matt lacq.	Lacc. lucido Glossy lacq.	Superfici UP UP surface
-----------------------------	---------------------------	------------------------------	----------------------------

483	642	749	786
-----	-----	-----	-----

529	726	856	898
-----	-----	-----	-----

638	862	1.010	1.060
-----	-----	-------	-------

L W	H H	P D	CODICE CODE
--------	--------	--------	----------------

x 8 paia pairs	90	90	20	MISP2851
-------------------	----	----	----	----------

x 16 paia pairs	90	90	26	MISP2852
--------------------	----	----	----	----------

x 24 paia pairs	90	90	35	MISP2853
--------------------	----	----	----	----------

Materico Textured finish	Lacc. opaco Matt lacq.	Lacc. lucido Glossy lacq.	Superfici UP UP surface
-----------------------------	---------------------------	------------------------------	----------------------------

521	717	845	887
-----	-----	-----	-----

593	814	962	1.010
-----	-----	-----	-------

708	941	1.099	1.154
-----	-----	-------	-------

Aggiungere sempre il top (pagina 233).
Moduli con predisposizione per fissaggio a parete. Piedi optional.
Maggiorazione (a frontale) per riduzione in larghezza:
P 20 / 26 cm € 211
P 35 cm € 444.

Always add the top (page 233).
Modules can also be wall mounted. Optional feet.
Surcharge (per front) for width reduction:
D 20 / 26 cm € 211
D 35 cm € 444.

IDROBOX BASI
IDROBOX BASE UNITS

IDROBOX COLONNE E PENSILI
IDROBOX TALL AND WALL UNITS

IDROBOX ATTREZZATURA
IDROBOX EQUIPMENT

IDROBOX TOP E LAVATOI
IDROBOX TOPS AND WASHBASINS

INGRESSI
HALLWAY CABINETS

SCARPIERE
SHOE CABINETS

ACCESSORI
ACCESSORIES

MOBILE PORTASCARPE H 135 cm

Shoe units h 135 cm

MINIMA

3 ante ribalta L 60 cm

3 W 60 cm tilt doors

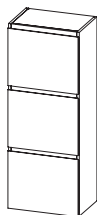

L W	H H	P D	CODICE CODE
--------	--------	--------	----------------

x 6 **paia**
pairs

60	135	20	MISP3B31
-----------	-----	----	----------

x 12 **paia**
pairs

60	135	26	MISP3B32
-----------	-----	----	----------

x 18 **paia**
pairs

60	135	35	MISP3B33
-----------	-----	----	----------

Materico Textured finish	Lacc. opaco Matt lacq.	Lacc. lucido Glossy lacq.	Superfici UP UP surface
-----------------------------	---------------------------	------------------------------	----------------------------

538	710	826	868
------------	------------	------------	------------

627	837	980	1.029
------------	------------	------------	--------------

660	893	1.045	1.098
------------	------------	--------------	--------------

3 ante ribalta L 75 cm

3 W 75 cm tilt doors

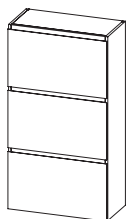

L W	H H	P D	CODICE CODE
--------	--------	--------	----------------

x 9 **paia**
pairs

75	135	20	MISP3B41
-----------	-----	----	----------

x 18 **paia**
pairs

75	135	26	MISP3B42
-----------	-----	----	----------

x 27 **paia**
pairs

75	135	35	MISP3B43
-----------	-----	----	----------

Materico Textured finish	Lacc. opaco Matt lacq.	Lacc. lucido Glossy lacq.	Superfici UP UP surface
-----------------------------	---------------------------	------------------------------	----------------------------

624	840	985	1.034
------------	------------	------------	--------------

683	926	1.087	1.141
------------	------------	--------------	--------------

841	1.131	1.325	1.392
------------	--------------	--------------	--------------

3 ante ribalta L 90 cm

3 W 90 cm tilt doors

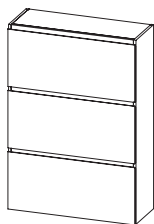

L W	H H	P D	CODICE CODE
--------	--------	--------	----------------

x 12 **paia**
pairs

90	135	20	MISP3B51
-----------	-----	----	----------

x 24 **paia**
pairs

90	135	26	MISP3B52
-----------	-----	----	----------

x 36 **paia**
pairs

90	135	35	MISP3B53
-----------	-----	----	----------

Materico Textured finish	Lacc. opaco Matt lacq.	Lacc. lucido Glossy lacq.	Superfici UP UP surface
-----------------------------	---------------------------	------------------------------	----------------------------

666	928	1.099	1.154
------------	------------	--------------	--------------

778	1.066	1.254	1.317
------------	--------------	--------------	--------------

903	1.209	1.413	1.484
------------	--------------	--------------	--------------

Aggiungere sempre il top (pagina 233).

Moduli con predisposizione per fissaggio a parete. Piedi optional.

Maggiorazione (a frontale) per riduzione in larghezza:

P 20 / 26 cm € 211

P 35 cm € 444.

Always add the top (page 233).

Modules can also be wall mounted. Optional feet.

Surcharge (per front) for width reduction:

D 20 / 26 cm € 211

D 35 cm € 444.

MOBILE PORTASCARPE H 180 cm

Shoe units h 180 cm

MINIMA

4 ante ribalta L 60 cm

4 W 60 cm tilt doors

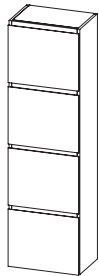

4 ante ribalta L 75 cm

4 W 75 cm tilt doors

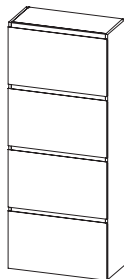

4 ante ribalta L 90 cm

4 W 90 cm tilt doors

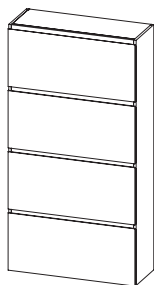

L W	H	P D	CODICE CODE
--------	---	--------	----------------

x 8 **paia**
pairs

60	180	20	MISP4D31
-----------	-----	----	----------

x 16 **paia**
pairs

60	180	26	MISP4D32
-----------	-----	----	----------

x 24 **paia**
pairs

60	180	35	MISP4D33
-----------	-----	----	----------

Materico Textured finish	Lacc. opaco Matt lacq.	Lacc. lucido Glossy lacq.	Superfici UP UP surface
-----------------------------	---------------------------	------------------------------	----------------------------

652	873	1.026	1.077
------------	------------	--------------	--------------

762	1.010	1.179	1.237
------------	--------------	--------------	--------------

809	1.118	1.321	1.387
------------	--------------	--------------	--------------

L W	H	P D	CODICE CODE
--------	---	--------	----------------

x 12 **paia**
pairs

75	180	20	MISP4D41
-----------	-----	----	----------

x 24 **paia**
pairs

75	180	26	MISP4D42
-----------	-----	----	----------

x 36 **paia**
pairs

75	180	35	MISP4D43
-----------	-----	----	----------

Materico Textured finish	Lacc. opaco Matt lacq.	Lacc. lucido Glossy lacq.	Superfici UP UP surface
-----------------------------	---------------------------	------------------------------	----------------------------

753	1.077	1.288	1.352
------------	--------------	--------------	--------------

844	1.155	1.358	1.425
------------	--------------	--------------	--------------

1.041	1.407	1.653	1.734
--------------	--------------	--------------	--------------

L W	H	P D	CODICE CODE
--------	---	--------	----------------

x 16 **paia**
pairs

90	180	20	MISP4D51
-----------	-----	----	----------

x 32 **paia**
pairs

90	180	26	MISP4D52
-----------	-----	----	----------

x 48 **paia**
pairs

90	180	35	MISP4D53
-----------	-----	----	----------

Materico Textured finish	Lacc. opaco Matt lacq.	Lacc. lucido Glossy lacq.	Superfici UP UP surface
-----------------------------	---------------------------	------------------------------	----------------------------

806	1.140	1.356	1.424
------------	--------------	--------------	--------------

956	1.320	1.560	1.638
------------	--------------	--------------	--------------

1.112	1.542	1.822	1.914
--------------	--------------	--------------	--------------

Aggiungere sempre il top (pagina 233).
Moduli con predisposizione per fissaggio a parete. Piedi optional.
Maggiorazione (a frontale) per riduzione in larghezza:
P 20 / 26 cm € 211
P 35 cm € 444.

Always add the top (page 233).
Modules can also be wall mounted. Optional feet.
Surcharge (per front) for width reduction:
D 20 / 26 cm € 211
D 35 cm € 444.

IDROBOX BASI
IDROBOX BASE UNITS

IDROBOX COLONNE E PENSILI
IDROBOX TALL AND WALL UNITS

IDROBOX ATTREZZATURA
IDROBOX EQUIPMENT

IDROBOX TOP E LAVATOI
IDROBOX TOPS AND WASHBASINS

INGRESSI
HALLWAY CABINETS

SCARPIERE
SHOE CABINETS

ACCESSORI
ACCESSORIES

ACCESSORI

Accessories

MINIMA

coppia piedi regolabili H 9 cm

pair of adjustable feet H 9 cm

Finiture bianco, nero, titanio o laccato

White, black, titanium or lacquered finishes



H H	CODICE CODE	Prezzo Price
9	UZ521	46

9	UZ521	46
---	-------	----

coppia piedi Lama H 12 cm

pair of H 12 cm Lama foot

Finiture bianco, nero, titanio

White, black, titanium finishes

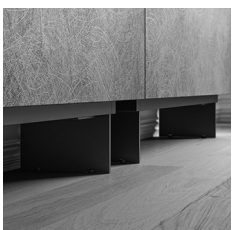

H H	P D	CODICE CODE	Prezzo Price
12	20	UZ524	229
12	35	UZ525	295

12	20	UZ524	229
12	35	UZ525	295

zoccolo al metro lineare

plinth per linear metre

Finitura di serie alluminio, nero, bianco oppure nelle colorazioni laccato opaco

Standard finishes: aluminium, black or white or coloured matt lacquers



H H	CODICE CODE	Prezzo Price	Lacc. opaco Matt lacq.
6	UZBMZOC6	50	75

6	UZBMZOC6	50	75
---	----------	----	----

ACCESSORI

Accessories

MINIMA

Top al metro lineare sp. 1,8 cm

Top per linear metre 1,8 cm th

L max 270 cm

Max. W 270 cm

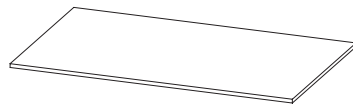

P D	SP TH	CODICE CODE
--------	----------	----------------

20	1,8	U6450101
26	1,8	U645010B
35	1,8	U6450102

Materico Textured finish	Lacc. opaco Matt lacq.	Lacc. lucido Glossy lacq.	Superfici UP UP surface
-----------------------------	---------------------------	------------------------------	----------------------------

94	133	173	199
112	169	225	261
129	207	277	324

sanificatore

sanitizer device

Dispositivo per il trattamento dell'aria con sistema a LED UV. Posizionabile solo su coperchio. Alimentatore incluso. La gestione del posizionamento dell'alimentatore sarà a cura del cliente. Il sistema di accensione deve essere collegato ad un interruttore della rete elettrica della stanza.

Air treatment device with UV LED system, to be placed only on the top panel. Power supply included. Installing the power supply in the correct positions is the customer's responsibility. The switch-on system must be connected to a main switch in the room.

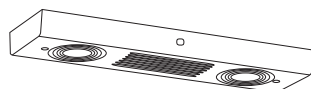

CODICE
CODE

Prezzo
Price

IRXSA001

215

IDROBOX BASI
IDROBOX BASE UNITS

IDROBOX COLONNE E PENSILI
IDROBOX TALL AND WALL UNITS

IDROBOX ATTREZZATURA
IDROBOX EQUIPMENT

IDROBOX TOP E LAVATOI
IDROBOX TOPS AND WASHBASINS

INGRESSI
HALLWAY CABINETS

SCARPIERE
SHOE CABINETS

ACCESSORI
ACCESSORIES

CARATTERISTICHE TECNICHE

Technical features

WELCOME



STRUTTURA: realizzata con pannelli di particelle di legno certificati CARB-2 sp. 18 mm rivestiti con nobilitazione melaminica o laccati. Fianchi con foratura passo 32 mm.

SCHIENE: realizzate con pannelli di particelle di legno certificati CARB-2 sp. 8 mm rivestiti con nobilitazione melaminica.

FRONTALI: telaio in alluminio nero rivestito con specchio.

APERTURA: mediante profilo verticale in alluminio nero.

ATTREZZATURA: ripiani in pannelli di particelle di legno sp. 18 mm rivestiti con nobilitazione melaminica e supporti in plastica colore antracite.

STRUCTURE: made of 18 mm th. CARB-2 certified wood particle board panel with melamine coating or lacquered. Side panels with hole spaced at 32 mm.

BACKS: made of 8 mm th. CARB-2 certified wood particle board panel with melamine coating.

FRONTALS: black aluminum frame covered with mirror.

OPENING: vertical black aluminum profile.

EQUIPMENT: shelves made of 18 mm thick wood particle board covered with melamine coating and anthracite-colored plastic supports.

MODULARITÀ MODULARITY

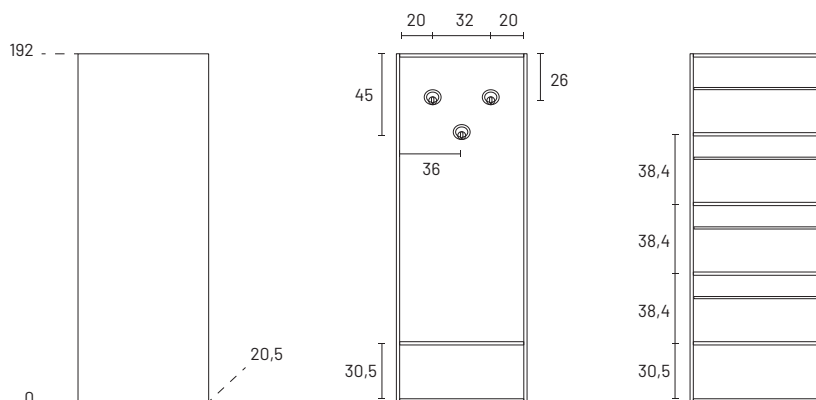

Schema posizionamento appendiabiti e ripiani
Position of clothes hooks and shelves

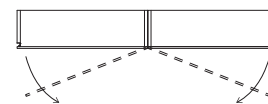

Per accostare due moduli è necessario che le ante abbiano senso di apertura opposto

For units positioned side by side, the doors must open in opposite directions

Lavorazioni su misura non disponibili.

Le scarpriere vanno sempre fissate a parete.

La quantità massima di scarpe è calcolata in modo indicativo considerando un assortimento uomo/donna/bambino e tenendo conto che la taglia massima delle scarpe è 45.

Customization not available.

Shoe racks must always be fixed to the wall.

The maximum number of shoes per cabinet is approximate, considering a combination of men's, women's and children's footwear and taking into account a maximum shoe size of 45.

LACCATI OPACHI E LUCIDI | MATT AND GLOSSY LACQUERS

							
9003 Bianco	9010 Panna	9001 Crema	1013 Fior di loto	9002 Ghiaccio	100 Sabbia	63 Tortora	68 Grigio perla
							
71 Light grey	7044 Grigio seta	62 Canapa	61 Corda	72 Dark grey	7039 Grigio aston	101 Giallo senape	173 Bruciato
							
3003 Rosso	3005 Rosso bordeaux	102 Rosa cipria	74 Terracotta	73 Moka	190 Verde pallido	103 Verde malva	104 Turchese
							
105 Oceano	106 Blu cobalto	246 Grigio Garda	107 Celeste	76 Carta da zucchero	7031 Grigio blu	7016 Grigio antracite	9017 Nero
							
Titanio	Nichel	Piombo					

MATERICI | TEXTURED FINISHES



Avana

SPECCHI | MIRRORS



Specchio
Mirror



Specchio fumo
Smoked mirror



Specchio bronzo
Bronze mirror

La riproduzione dei colori su carta può risultare alterata rispetto agli originali, pertanto queste tinte sono da considerarsi indicative. Laccato a campione/RAL con maggiorazione del 20%.

The reproduction of the colours on paper may be different compared to the original ones, therefore these shades should be considered as representative only. 20% surcharge for custom colour/RALs.

MOBILE PORTASCARPE H 192 cm

Shoe units h 192 cm

WELCOME

1 anta battente specchio

1 mirror hinged door

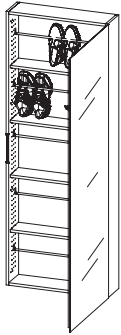

4 ripiani portascarpe

4 shoe shelves

1 anta battente specchio

1 mirror hinged door

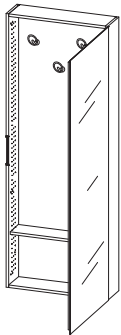

3 appendiabiti e 1 ripiano

3 hooks and 1 shelf

sanificatore

sanitizer device

Dispositivo per il trattamento dell'aria con sistema a LED UV. Posizionabile solo su coperchio. Alimentatore incluso. La gestione del posizionamento dell'alimentatore sarà a cura del cliente. Il sistema di accensione deve essere collegato ad un interruttore della rete elettrica della stanza.

Air treatment device with UV LED system, to be placed only on the top panel. Power supply included. Intalling the power supply in the correct positions is the customer's responsibility. The swich-on system must be connected to a main switch in the room.

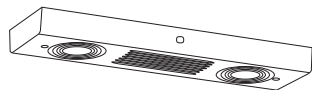

L W	H H	P D	CODICE CODE
--------	--------	--------	----------------

Materico Textured finish	Lacc. opaco Matt lacq.	Lacc. lucido Glossy lacq.
-----------------------------	---------------------------	------------------------------

specchio
mirror x 15 paia
pairs

dx rh	72	192	20,5	WEA1920D
sx lh	72	192	20,5	WEA1920S

937	1.101	1.126
937	1.101	1.126

specchio fumo/bronzo
smoked/bronze mirror x 15 paia
pairs

dx rh	72	192	20,5	WEA1921D
sx lh	72	192	20,5	WEA1921S

1.026	1.186	1.220
1.026	1.186	1.220

L W	H H	P D	CODICE CODE
--------	--------	--------	----------------

Materico Textured finish	Lacc. opaco Matt lacq.	Lacc. lucido Glossy lacq.
-----------------------------	---------------------------	------------------------------

specchio
mirror

dx rh	72	192	20,5	WEF1920D
sx lh	72	192	20,5	WEF1920S

937	1.101	1.126
937	1.101	1.126

specchio fumo/bronzo
smoked/bronze mirror

dx rh	72	192	20,5	WEF1921D
sx lh	72	192	20,5	WEF1921S

1.026	1.186	1.220
1.026	1.186	1.220

CODICE
CODE

Prezzo
Price

IRXSA001

215

ACCESSORI

Accessories

WELCOME

sostegno ferma scarpe
shoe holder support



CODICE CODE	Prezzo Price
----------------	-----------------

WEACFTO	10
---------	----

ripiano
shelf



CODICE CODE	Prezzo Price
----------------	-----------------

WEACFRO	30
---------	----

Appendino GAMMA
GAMMA hook

Finitura metallo verniciato nero
Painted black metal finish



CODICE CODE	Prezzo Price
----------------	-----------------

U5060580	47
----------	----

coppia piedi regolabili H 9 cm
pair of adjustable feet H 9 cm

Finiture bianco, nero, titanio o laccato
White, black, titanium or lacquered finishes



H H	CODICE CODE	Prezzo Price
--------	----------------	-----------------

9	UZ521	46
---	-------	----

IDROBOX BASI
IDROBOX BASE UNITS

IDROBOX COLONNE E PENSILI
IDROBOX TALL AND WALL UNITS

IDROBOX ATTREZZATURA
IDROBOX EQUIPMENT

IDROBOX TOP E LAVATOI
IDROBOX TOPS AND WASHBASINS

INGRESSI
HALLWAY CABINETS

SCARPIERE
SHOE CABINETS

ACCESSORI
ACCESSORIES

ACCESSORI

Accessories

SCHIENALI ATTREZZABILI Back panels with accessories	P. 240
PANNELLI Panels	P. 242
APPENDIABITI Clothes hooks	P. 243
MENSOLE Shelves	P. 244
SPECCHIERE Mirrors	P. 246
ILLUMINAZIONE Lighting	P. 250
POUF E CONSOLE Pouf and consoles	P. 253

SCHIENALI ATTREZZABILI

Back panels with accessories

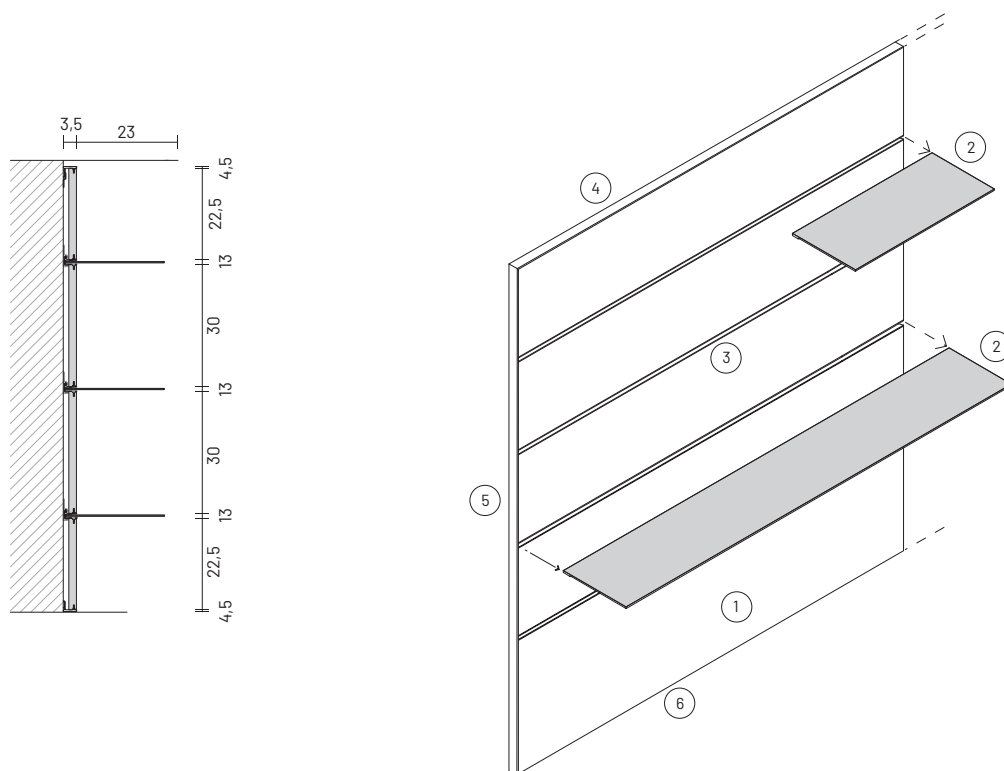

- ① **schienali attrezzabili**
back panels with accessories
- ② **mensole in metallo**
metal shelves
- ③ **profilo centrale**
central profile
- ④ **profilo superiore**
upper profile
- ⑤ **profilo laterale**
side profile
- ⑥ **profilo inferiore**
lower profile

Gli schienali attrezzabili sono componibili in altezza e larghezza accostando più moduli nelle misure scelte. Sono attrezzabili con mensole in metallo utilizzando i profili di raccordo tra pannelli. I profili di chiusura superiori ed inferiori devono essere sempre inseriti mentre i profili laterali non sono necessari se si accostano più moduli oppure se la pannellatura va montata in nicchia. Per il montaggio in nicchia del profilo superiore e di quello laterale è necessario uno spazio minimo di 2 cm.

Nel caso di accostamento laterale di pannelli l'altezza totale (data dalla somma dei pannelli e dei profili) deve risultare uguale.

Non è possibile l'inserimento di passacavi e luci LED negli schienali attrezzabili.

Accessorisable back panels in your chosen sizes can be positioned side by side and above one another. They can be fitted with metal shelves using connecting profiles between panels. The upper and lower end profiles must always be inserted, while the side profiles are not necessary if several units are positioned side by side or if the panelling is to be mounted in a niche. Minimum clearance of 2 cm is required to install the top and side profiles in a niche. Where panels are positioned side by side, the total height (sum of panels and profiles) must be the same.

Grommets and LED lights cannot be used for accessorisable back panels.

Prezzo schienali comprensivo di profili con sistema di fissaggio del pannello al muro e di profili laterali. Profili disponibili in finitura bianco, nero, titanio, ottone anticato.

The back panel price includes profiles with a mechanism for fastening the panels to the wall, and side profiles. Profiles available in white, black, titanium and antiqued brass.

SCHIENALI ATTREZZABILI

Back panels with accessories

Schienali

Back panels

Il senso vena segue sempre l'orizzontalità del pannello

The grain is always horizontal

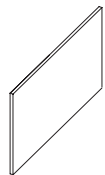

	L W	H H	SP TH	CODICE CODE	Materico Textured finish	Lacc. opaco Matt lacq.	Lacc. lucido Glossy lacq.	Essenza Wood	Superfici UP UP surface
H 22,5	75	22,5	1,8	USA01140	211	229	252	268	256
	90	22,5	1,8	USA01150	232	251	274	292	280
	105	22,5	1,8	USA01160	256	277	305	328	312
	120	22,5	1,8	USA01170	281	305	337	363	344
H 30	75	30	1,8	USA01240	233	258	287	309	292
	90	30	1,8	USA01250	256	281	313	337	319
	105	30	1,8	USA01260	281	310	346	374	354
	120	30	1,8	USA01270	304	340	380	412	388
H 37,5	75	37,5	1,8	USA01340	256	286	321	349	330
	90	37,5	1,8	USA01350	282	312	350	382	359
	105	37,5	1,8	USA01360	305	342	387	420	397
	120	37,5	1,8	USA01370	329	372	425	458	432
H 45	75	45	1,8	USA01440	295	333	378	413	389
	90	45	1,8	USA01450	326	363	413	450	425
	105	45	1,8	USA01460	349	397	455	495	466
	120	45	1,8	USA01470	374	428	495	542	508
H 60	75	60	1,8	USA01540	334	382	436	476	449
	90	60	1,8	USA01550	369	415	476	519	489
	105	60	1,8	USA01560	394	450	521	571	536
	120	60	1,8	USA01570	420	484	566	623	584

Mensole in metallo

Metal shelves

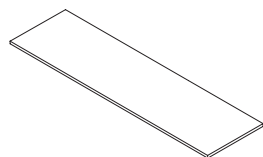

L W	P D	SP TH	CODICE CODE	Metallo 1 Metal 1	Metallo 2 Metal 2
75	23	0,3	USAM0041	207	268
90	23	0,3	USAM0051	261	340
105	23	0,3	USAM0061	289	375
120	23	0,3	USAM0071	316	411

Prezzo schienali comprensivo di profili con sistema di fissaggio del pannello al muro e di profili laterali.
 Profili disponibili in finitura bianco, nero, titanio, ottone anticato.
 Metallo 1 = nero, bianco, titanio.
 Metallo 2 = ottone anticato.

The back panel price includes profiles with a mechanism for fastening the panels to the wall, and side profiles. Profiles available in white, black, titanium and antiqued brass.
 Metal 1 = black, white, titanium.
 Metal 2 = antiqued brass.

IDROBOX BASI
IDROBOX BASE UNITS

IDROBOX COLONNE E PENSILI
IDROBOX TALL AND WALL UNITS

IDROBOX ATTREZZATURA
IDROBOX EQUIPMENT

IDROBOX TOP E LAVATOI
IDROBOX TOPS AND WASHBASINS

INGRESSI
HALLWAY CABINETS

SCARPIERE
SHOE CABINETS

ACCESSORI
ACCESSORIES

PANNELLI

Panels

Pannello al metro quadro bordato 4 lati

Panel per square metre edged on 4 sides

Dimensioni massime 280x100 cm

Maximum size 280x100 cm

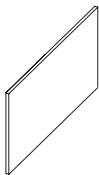

SP TH	CODICE CODE
1,8	UPA00100
2,2	UPA00101

Materico Textured finish	Lacc. opaco Matt lacq.	Lacc. lucido Glossy lacq.	Essenza Wood	Superfici UP UP surface
115	357	707	503	596
120	369	719	515	607

1,8	UPA00100
2,2	UPA00101

115	357	707	503	596
120	369	719	515	607

Pannelli boiserie sp. 1,8 cm

Panelling 1,8 cm thick

Il senso vena segue sempre l'orizzontalità del pannello.

Attaccaglie incluse

The grain is always horizontal. Fasteners included

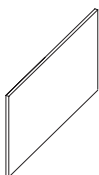

L W	H H	SP TH	CODICE CODE
--------	--------	----------	----------------

Materico Textured finish	Lacc. opaco Matt lacq.	Lacc. lucido Glossy lacq.	Essenza Wood	Superfici UP UP surface
-----------------------------	---------------------------	------------------------------	-----------------	----------------------------

H 45	L	H	SP	CODICE
	60	45	1,8	USB01420
	75	45	1,8	USB01440
	90	45	1,8	USB01450
	105	45	1,8	USB01480

96	134	175	210	185
113	157	212	253	223
129	182	250	296	261
141	202	281	337	295

H 90	L	H	SP	CODICE
	60	90	1,8	USB01820
	75	90	1,8	USB01840
	90	90	1,8	USB01850
	105	90	1,8	USB01880

153	213	281	335	296
180	252	340	404	357
207	290	398	472	416
225	323	449	537	471

H 120	L	H	SP	CODICE
	60	120	1,8	USB01A20
	75	120	1,8	USB01A40
	90	120	1,8	USB01A50
	105	120	1,8	USB01A80

175	245	323	386	341
207	289	390	464	409
237	333	457	544	478
259	371	517	618	542

Fascia di tamponamento al metro lineare

Filler strip per linear metre

L max 15 cm

Max. W 15 cm



SP TH	CODICE CODE
1,8	UFTV0100
2,2	UFTV0101

Materico Textured finish	Lacc. opaco Matt lacq.	Lacc. lucido Glossy lacq.	Essenza Wood	Superfici UP UP surface
-----------------------------	---------------------------	------------------------------	-----------------	----------------------------

1,8	UFTV0100
2,2	UFTV0101

104	129	255	182	215
114	140	266	193	225

APPENDIABITI

Clothes hooks

Appendino POMOLO

POMOLO hook

Finitura metallo bianco, nero o titanio
White, black or titanium metal finish

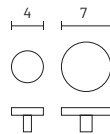
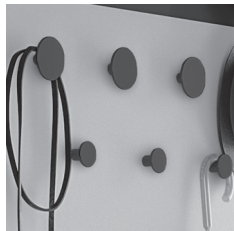

L W	H H	P D	CODICE CODE	Prezzo Price
4	4	2,5	U5060560	34
7	7	2,5	U5060570	50

Appendino GAMMA

GAMMA hook

Finitura metallo verniciato nero
Painted black metal finish



CODICE CODE	Prezzo Price
U5060580	47

Appendino FUNGO

FUNGO hook

Finitura laccato opaco bianco o laccato colore
Matt white lacquer or colored lacquer finish

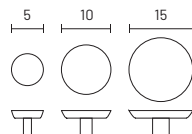

L W	CODICE CODE	Bianco White	Lacc. opaco Matt lacq.
5	U506063	30	77
10	U506064	46	92
15	U506065	62	108

barra appendiabiti LINE

LINE clothes rail

mensola in metallo con ganci appendiabiti e frontalino in gres
metal shelf with clothes rail and stoneware front

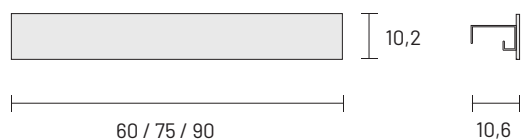

L W	H H	P D	CODICE CODE	Prezzo Price
60	10,2	10,6	U1064M1	362
75	10,2	10,6	U1064M2	444
90	10,2	10,6	U1064M3	515

4 ganci | 4 hangers

5 ganci | 5 hangers

6 ganci | 6 hangers

IDROBOX BASI
IDROBOX BASE UNITS

IDROBOX COLONNE E PENSILI
IDROBOX TALL AND WALL UNITS

IDROBOX ATTREZZATURA
IDROBOX EQUIPMENT

IDROBOX TOP E LAVATOI
IDROBOX TOPS AND WASHBASINS

INGRESSI
HALLWAY CABINETS

SCARPIERE
SHOE CABINETS

ACCESSORI
ACCESSORIES

MENSOLE

Shelves

Mensole vassoio in metallo

Metal tray shelves

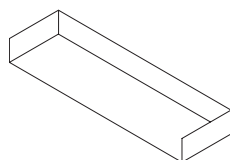

L W	H H	P D	CODICE CODE
--------	--------	--------	----------------

Metallo 1 Metal 1	Metallo 2 Metal 2	+ luce LED + LED light
----------------------	----------------------	---------------------------

60	7,5	26	U506121
90	7,5	26	U506122
120	7,5	26	U506123
150	7,5	26	U506124
180	7,5	26	U506125

416	542	246
505	656	265
598	778	309
650	844	396
817	1.062	440

Mensole in metallo

Metal shelves

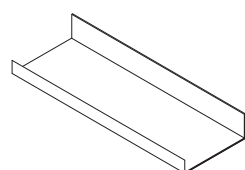

L W	H H	P D	CODICE CODE
--------	--------	--------	----------------

Metallo 1 Metal 1	Metallo 2 Metal 2
----------------------	----------------------

60	7	13,1	U506141
75	7	13,1	U506142
90	7	13,1	U506143
105	7	13,1	U506144
120	7	13,1	U506145

125	162
131	171
164	213
187	243
189	246

Mensole in metallo con portasalviette

Metal shelves with towel rail

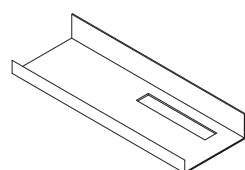
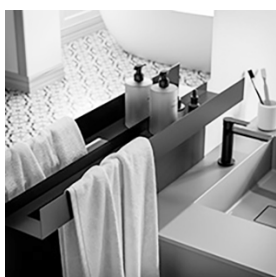

L W	H H	P D	CODICE CODE
--------	--------	--------	----------------

Metallo 1 Metal 1	Metallo 2 Metal 2
----------------------	----------------------

dx rh	75	7	13,1	U506131
sx lh	75	7	13,1	U506132
dx rh	90	7	13,1	U506133
sx lh	90	7	13,1	U506134

142	185
142	185
173	225
173	225

Metallo 1 = nero, bianco, titanio.
Metallo 2 = ottone anticato.

Metal 1 = black, white, titanium.
Metal 2 = antiqued brass.

MENSOLE

Shelves

Mensole in legno al metro lineare sp 2,2 cm

Wooden shelves per linear metre 2,2 cm thick

Adatte solo per fissaggio direttamente a parete (non su pannellature).

L max 270 cm.

Only suitable for direct wall mounting (not on panels).

Max. W 270 cm.

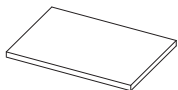

P D	SP TH	CODICE CODE
18	2,2	U6451101
33	2,2	U6451102

Materico Textured finish	Lacc. opaco Matt lacq.	Lacc. lucido Glossy lacq.	Essenza Wood	Superfici UP UP surface
125	148	166	258	199
140	181	211	362	269

18	2,2	U6451101
33	2,2	U6451102

125	148	166	258	199
140	181	211	362	269

Mensole in legno al metro lineare sp 4 cm

Wooden shelves per linear metre 4 cm thick

L max 270 cm. Finitura materico disponibile solo nelle varianti Bianco, Avana, Quarzo, Sabbia, Noce alabama, Rovere termotrattato, Perla e Argilla

Max. W 270 cm. Textured finish only available in Bianco, Avana, Quarzo, Sabbia, Alabama Walnut, heat-treated Oak, Perla and Argilla

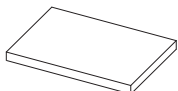

P D	SP TH	CODICE CODE
18	4	U6451301
33	4	U6451302

Materico Textured finish	Lacc. opaco Matt lacq.	Lacc. lucido Glossy lacq.	Essenza Wood	Superfici UP UP surface
126	164	181	289	214
179	180	234	405	294

18	4	U6451301
33	4	U6451302

126	164	181	289	214
179	180	234	405	294

Reggimensola a scomparsa

Concealed bracket

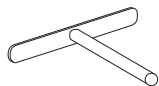

P D	CODICE CODE	Prezzo Price
--------	----------------	-----------------

per mensola sp 2,2 cm
for shelf 2.2 cm thick

18	UZ1421	15
33	UZ1423	15

per mensola sp 4 cm
for shelf 4 cm thick

18	UZ1441	17
33	UZ1443	17

Prevedere due reggimensola ogni 90 cm di mensola.

Use two shelf brackets for every 90 cm of shelf.

IDROBOX BASI
IDROBOX BASE UNITS

IDROBOX COLONNE E PENSILI
IDROBOX TALL AND WALL UNITS

IDROBOX ATTREZZATURA
IDROBOX EQUIPMENT

IDROBOX TOP E LAVATOI
IDROBOX TOPS AND WASHBASINS

INGRESSI
HALLWAY CABINETS

SCARPIERE
SHOE CABINETS

ACCESSORI
ACCESSORIES

SPECCHIERE

Mirrors

FILO LUCIDO

Specchiera con telaio in materiale termoplastico rivestito cromo lucido rientrante 16 mm. Specchio 4 mm con verniciatura antisfondamento. Per specchiere a misura considerare il prezzo della misura superiore. LED perimetrale optional.

Mirror with thermoplastic frame with polished chrome coating, 16 mm recess. 4 mm mirror with security coating. For made-to-measure mirrors, please consider the price of the larger size. Optional perimeter LED.



L W	H H	P D	CODICE CODE	Prezzo Price	+ luce LED + LED light
--------	--------	--------	----------------	-----------------	---------------------------

H 45				Prezzo	+ luce LED
60	45	2,6	U106301	153	268
75	45	2,6	U106302	170	286
90	45	2,6	U106303	187	302
105	45	2,6	U106304	205	318
120	45	2,6	U106305	224	361
135	45	2,6	U106306	241	378
150	45	2,6	U106307	259	396
165	45	2,6	U106308	276	437
180	45	2,6	U106309	294	454

H 60				Prezzo	+ luce LED
60	60	2,6	U106311	174	286
75	60	2,6	U106312	197	304
90	60	2,6	U106313	219	321
105	60	2,6	U106314	241	364
120	60	2,6	U106315	263	383
135	60	2,6	U106316	286	401
150	60	2,6	U106317	308	443
165	60	2,6	U106318	330	461
180	60	2,6	U106319	354	479

H 75				Prezzo	+ luce LED
45	75	2,6	U10632A	170	286
60	75	2,6	U106321	197	304
75	75	2,6	U106322	224	321
90	75	2,6	U106323	251	368
105	75	2,6	U106324	277	386
120	75	2,6	U106325	304	404
135	75	2,6	U106326	331	448
150	75	2,6	U106327	358	466
165	75	2,6	U106328	385	485
180	75	2,6	U106329	412	504
195	75	2,6	U106330	438	522

Per una maggiore selezione di accessori consigliamo di consultare il listino Bathroom.

Please see the Bathroom price list for the full range of accessories.

SPECCHIERE

Mirrors

FILO LUCIDO

L W	H H	P D	CODICE CODE	Prezzo Price	+ luce LED + LED light
--------	--------	--------	----------------	-----------------	---------------------------

H 90	L	H	P	CODICE	Prezzo	+ luce LED
	45	90	2,6	U106331	187	302
	60	90	2,6	U106332	219	321
	75	90	2,6	U106333	251	368
	90	90	2,6	U106334	282	387
	105	90	2,6	U106335	314	405
	120	90	2,6	U106336	345	450
	135	90	2,6	U106337	376	470
	150	90	2,6	U106338	408	490
	165	90	2,6	U106339	438	509
	180	90	2,6	U10634A	470	530

H 105	L	H	P	CODICE	Prezzo	+ luce LED
	45	105	2,6	U106340	205	318
	60	105	2,6	U106341	241	364
	75	105	2,6	U106342	277	386
	90	105	2,6	U106343	314	405
	105	105	2,6	U106344	349	451
	120	105	2,6	U106345	386	472
	135	105	2,6	U106346	421	492
	150	105	2,6	U106347	457	513
	165	105	2,6	U106348	493	533
	180	105	2,6	U106349	530	553
	195	105	2,6	U106350	565	574

H 120	L	H	P	CODICE	Prezzo	+ luce LED
	45	120	2,6	U106351	224	361
	60	120	2,6	U106352	263	383
	75	120	2,6	U106353	304	404
	90	120	2,6	U106364	345	450

Presa elettrica e interruttore a bilanciere

Electrical socket and rocker switch

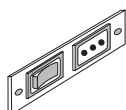

CODICE CODE	Prezzo Price
U501001	36

Interruttore a sfioro

Touch switch

CODICE CODE	Prezzo Price
U501002	75

Resistenza antiappannamento

Anti-misting resistor

CODICE CODE	Prezzo Price
U501003	114

Per una maggiore selezione di accessori consigliamo di consultare il listino Bathroom.

Please see the Bathroom price list for the full range of accessories.

IDROBOX BASI
IDROBOX BASE UNITS

IDROBOX COLONNE E PENSILI
IDROBOX TALL AND WALL UNITS

IDROBOX ATTREZZATURA
IDROBOX EQUIPMENT

IDROBOX TOP E LAVATOI
IDROBOX TOPS AND WASHBASINS

INGRESSI
HALLWAY CABINETS

SCARPIERE
SHOE CABINETS

ACCESSORI
ACCESSORIES

SPECCHIERE

Mirrors

RADIUS

Specchiera filo lucido

Polished edge mirror

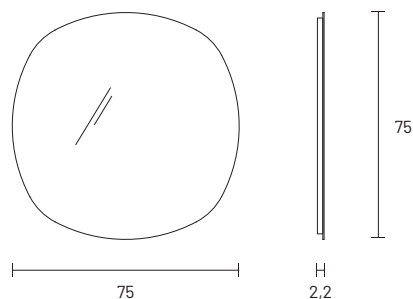

L W	H H	P D	CODICE CODE	Prezzo Price	+ luce LED + LED light
75	75	2,2	U104001	269	165

ROTONDA

Specchiera rotonda filo lucido

Polished edge round mirror

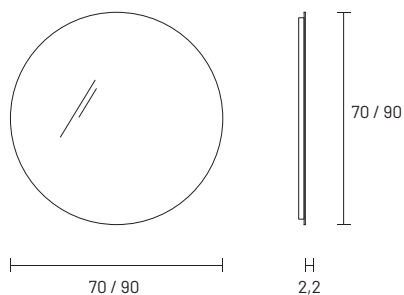

L W	H H	P D	CODICE CODE	Prezzo Price	+ luce LED + LED light
70	70	2,2	U105003	248	125
90	90	2,2	U105004	288	165

SELENE

Specchiera con bordo in vetro decorato

Mirror with decorated glass edge

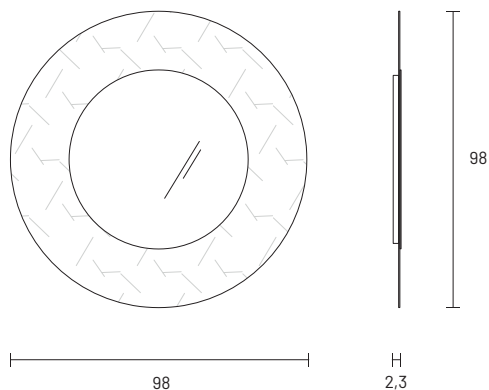

L W	H H	P D	CODICE CODE	Prezzo Price	+ luce LED + LED light
98	98	2,3	U103801	650	145

Per una maggiore selezione di accessori consigliamo di consultare il listino Bathroom.

Please see the Bathroom price list for the full range of accessories.

SPECCHIERE

Mirrors

SPECCHIERA ATTREZZATA

Specchiera attrezzata con n. 2 appendini Fungo Ø 5 cm, n. 3 Ø 10 cm e n. 2 mensole 38x2,2x18 cm in finitura laccato opaco

Mirror fitted with Fungo hooks (2 x Ø 5 cm, 3 x Ø 10 cm) and 2 shelves 38x2,2x18 cm in a matt lacquer finish

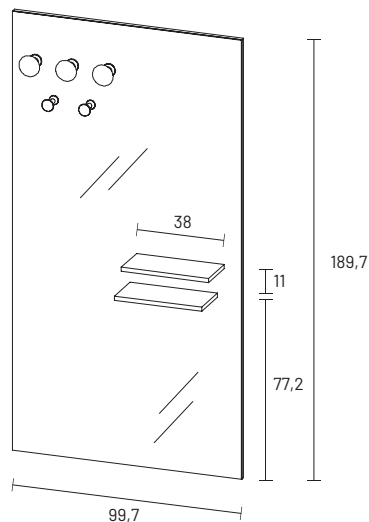

L W	H H	P D	CODICE CODE
99,7	189,7	1,8	U117001

Lacc. opaco Matt lacq.

99,7	189,7	1,8	U117001
------	-------	-----	---------

1.085

Per una maggiore selezione di accessori consigliamo di consultare il listino Bathroom.

Please see the Bathroom price list for the full range of accessories.

ACCESSORI
ACCESSORIES

SCARPIERE
SHOE CABINETS

INGRESSI
HALLWAY CABINETS

IDROBOX TOP E LAVATOI
IDROBOX TOPS AND WASHBASINS

IDROBOX ATTREZZATURA
IDROBOX EQUIPMENT

IDROBOX COLONNE E PENSILI
IDROBOX TALL AND WALL UNITS

IDROBOX BASI
IDROBOX BASE UNITS

ILLUMINAZIONE

Lighting

ATOS 300

Lampada LED 7W, alimentatore incorporato
7W LED lamp, built-in power supply unit

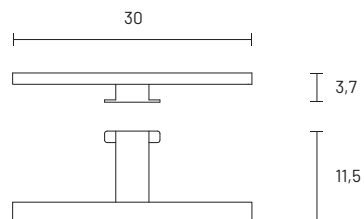

Finitura Finish	L W	H H	P D	CODICE CODE	Prezzo Price
--------------------	--------	--------	--------	----------------	-----------------

nero black	30	3,7	11,5	U205001K	77
cromo chrome	30	3,7	11,5	U205001C	77

4200 K - 560 LM - 230 Volt

IP44 A++ CE

ATOS 500

Lampada LED 8W, alimentatore incorporato
8W LED lamp, built-in power supply unit

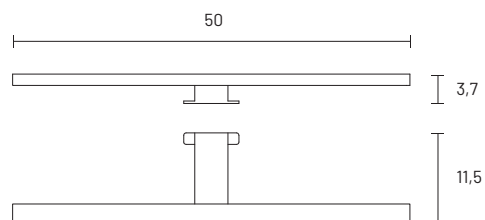

Finitura Finish	L W	H H	P D	CODICE CODE	Prezzo Price
--------------------	--------	--------	--------	----------------	-----------------

nero black	50	3,7	11,5	U205002K	100
cromo chrome	50	3,7	11,5	U205002C	100

4200 K - 640 LM - 230 Volt

IP44 A++ CE

Per una maggiore selezione di accessori consigliamo di consultare il listino Bathroom.

Please see the Bathroom price list for the full range of accessories.

ILLUMINAZIONE

Lighting

PROFILO LED

9,6W/mt, alimentatore esterno compreso
9,6W/m external power supply unit included

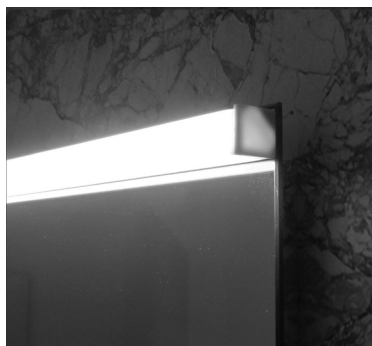

IP21 CE

Finitura Finish	L W	H H	P D	CODICE CODE	Prezzo Price
nero black	60	1,8	1,8	U205051	120
	75	1,8	1,8	U205052	126
	90	1,8	1,8	U205053	131
	105	1,8	1,8	U205054	138
	120	1,8	1,8	U205055	143
	135	1,8	1,8	U205056	160
	150	1,8	1,8	U205057	167
	165	1,8	1,8	U205058	172
	180	1,8	1,8	U205059	179
	195	1,8	1,8	U20505A	184

5500 K - 230 Volt

T

Profilo in alluminio zincato con frontale in specchio, 9,6W/mt, alimentatore incluso
Galvanised aluminium profile with mirrored front, 9,6W/m, supply unit included

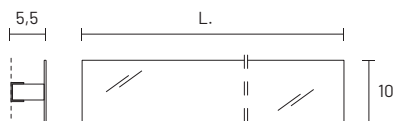

Finitura Finish	L W	H H	P D	CODICE CODE	Prezzo Price
specchio mirror	60	10	5,5	U205061	267
	75	10	5,5	U205062	281
	90	10	5,5	U205063	296
	105	10	5,5	U205064	310
	120	10	5,5	U205065	326
	135	10	5,5	U205066	357
	150	10	5,5	U205067	372
	165	10	5,5	U205068	387
	180	10	5,5	U205069	397
	195	10	5,6	U20506A	432

3000 K - LM - 230 Volt

Per una maggiore selezione di accessori consigliamo di consultare il listino Bathroom.

Please see the Bathroom price list for the full range of accessories.

IDROBOX BASI
IDROBOX BASE UNITS

IDROBOX COLONNE E PENSILI
IDROBOX TALL AND WALL UNITS

IDROBOX ATTREZZATURA
IDROBOX EQUIPMENT

IDROBOX TOP E LAVATOI
IDROBOX TOPS AND WASHBASINS

INGRESSI
HALLWAY CABINETS

SCARPIERE
SHOE CABINETS

ACCESSORI
ACCESSORIES

ACCESSORI

Accessories

cuscino sfoderabile in appoggio

cushion with removable cover

utilizzabile su basi a terra ingressi Gola UP, scarpiera a terra Gola Up e Minima

for Gola UP floor-standing hallway base units, Gola Up and Minima floor-standing shoe cabinets

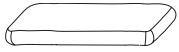

L W	H H	P D	CODICE CODE
--------	--------	--------	----------------

P 35

45	5	34	U5063220
60	5	34	U5063320
75	5	34	U5063420
90	5	34	U5063520
105	5	34	U5063620
120	5	34	U5063720

P 50

45	5	49	U5063720
60	5	49	U5063340
75	5	49	U5063440
90	5	49	U5063540
105	5	49	U5063640
120	5	49	U5063740

Basic	Start	Extra	Light	Super	K	W	t-cliente cust-fabric
-------	-------	-------	-------	-------	---	---	--------------------------

104	107	108	113	119	135	164	84
139	142	144	151	158	181	216	112
172	178	180	187	198	225	270	139
207	212	215	225	237	270	324	167
241	248	252	262	276	315	377	194
275	283	287	300	316	359	432	222

148	153	154	160	169	194	232	119
197	202	205	214	226	258	309	158
246	253	256	267	282	321	386	198
295	303	308	320	339	385	463	238
344	354	359	374	394	449	539	276
393	404	409	427	450	513	617	316

CONSOLE

Consoles

SUPERNOVA

console con piano in legno
console with wooden top

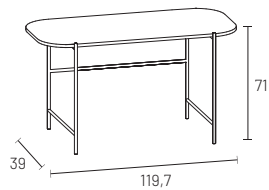

L W	H H	P D	CODICE CODE
--------	--------	--------	----------------

basamento metallo 1
metal base 1

119,7	71	39	U509SN044
-------	----	----	-----------

basamento metallo 2
metal base 2

119,7	71	39	U509SN044
-------	----	----	-----------

Materico Textured finish	Lacc. opaco Matt lacq.	Lacc. lucido Glossy lacq.	Essenza Wood	Superfici UP UP surface
-----------------------------	---------------------------	------------------------------	-----------------	----------------------------

768	854	923	911	923
969	1.055	1.123	1.112	1.123

SUPERNOVA

console con piano in gres
console with stoneware top

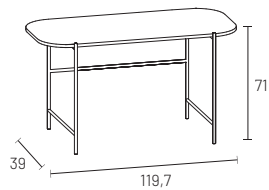

L W	H H	P D	CODICE CODE	Gres Stoneware
--------	--------	--------	----------------	-------------------

basamento metallo 1
metal base 1

119,7	71	39	U509SN144
-------	----	----	-----------

1.199

basamento metallo 2
metal base 2

119,7	71	39	U509SN144
-------	----	----	-----------

1.399

CONDIZIONI GENERALI DI VENDITA

General sales conditions

PREZZI

I prezzi del seguente listino sono espressi in unità di Euro.

I prezzi sono al pubblico I.V.A. esclusa.

I prezzi non costituiscono offerta e sono suscettibili di variazione senza alcun preavviso. I prezzi si intendono franco sede DA group s.r.l., salvo diverso patto espresso.

ORDINI

Gli ordini sono accettati con la clausola "salvo approvazione della casa".

Gli ordini anticipati telefonicamente dovranno essere seguiti da conferma scritta; contrariamente non ci assumeremo la responsabilità per eventuali errori di consegna.

CONSEGNA

Le consegne saranno effettuate nei termini concordati con il nostro ufficio vendite.

Per consegne in Italia di ordini con importi netti inferiori a € 500,00 viene applicato un contributo forfetario pari a € 50,00. Per consegne fuori dall'Italia di ordini con importi netti inferiori a € 750,00 viene applicato un contributo forfetario pari a € 75,00.

La mancata o ritardata consegna, anche se pattuita, o per causa di forza maggiore non costituisce alcun diritto per il cliente a risarcimento danni.

Le consegne richieste con spedizione a mezzo corriere espresso viaggiano in porto assegnato. Non si effettuano consegne ai privati.

RECLAMI

Le contestazioni per danni derivanti dal trasporto devono essere fatte al momento dello scarico.

Eventuali reclami per difetti di fabbricazione dovranno essere comunicati entro 8 giorni dal ricevimento della merce.

Viene declinata ogni responsabilità per errori od anomalie riscontrate nel montaggio di nostri modelli, salvo non siano stati effettuati da nostro personale specializzato.

RESI

I resi per difetto di fabbricazione dovranno essere preventivamente autorizzati per iscritto e dovranno pervenirci perfettamente imballati. Qualora, ad insindacabile giudizio dell'azienda vengono riconosciuti i difetti contestati, gli stessi verranno accreditati al valore effettivamente pagato.

PAGAMENTI

Non sono validi i pagamenti se non fatti direttamente alla nostra sede.

In caso di ritardato pagamento decorreranno gli interessi commerciali nella misura dal tasso ufficiale di sconto aumentato di 7 punti (DL 231 del 09.10.02).

Clausola di riserva di proprietà: la merce rimane di nostra proprietà a completo pagamento della fattura di riferimento.

FORO COMPETENTE

Per ogni controversia il foro competente è eletto a Pordenone.

MODIFICHE AI PRODOTTI

Le descrizioni e le caratteristiche tecniche dei prodotti richiamati nel presente listino sono puramente indicativi e non vincolanti. L'azienda si riserva il diritto di modificare, senza alcun preavviso, i materiali e le caratteristiche tecniche dei prodotti per motivi tecnici e/o produttivi.

Le misure indicate sono espresse in centimetri.

Il presente listino annulla e sostituisce il precedente e potrà essere modificato senza preavviso alcuno in ragione degli aumenti delle materie prime, del costo della manodopera e quant'altro potrà verificarsi in maniera imprevedibile.

DIRITTO DI PROPRIETÀ

È vietata la pubblicità, con foto o con altri mezzi, della merce fornita senza la preventiva autorizzazione scritta di DA group s.r.l.

UTILIZZO DEL MARCHIO

È fatto divieto assoluto a tutti i clienti, salvo patto contrario, l'utilizzo del marchio "Birex". In caso di accertata violazione DA group s.r.l. si riserva il diritto di agire giudizialmente per ottenere il riconoscimento dei danni.

Per le altre condizioni Generali di Vendita consultare la relativa documentazione commerciale.

L'azienda non risponde per eventuali errori di stampa relativi a caratteristiche tecniche, misure e ai prezzi indicati sul presente listino.

PRICES

Prices are given in euros.

VAT excluded.

The prices do not constitute an offer and are subject to change without any prior notice. Prices are to be considered ex works DA group s.r.l., unless expressly agreed otherwise.

ORDERS

Orders are accepted with the clause "subject to approval by the company".

Telephone orders must be confirmed in writing, otherwise we shall take no responsibility for any delivery errors.

DELIVERY

Deliveries will be carried out according to the terms agreed with our sales department.

For order deliveries in Italy with a net total of less than € 500,00 a fixed fee of € 50,00 is applied. For order deliveries outside Italy with a net total of less than € 750,00 a fixed fee of € 75,00 is applied.

Failure to deliver or delayed delivery, including where agreed, or due to force majeure shall not constitute any right to damages on the part of the customer.

Deliveries requested by express courier travel with carriage forward. We do not deliver to private individuals.

COMPLAINTS

Any damage caused during transportation should be contested when the furniture is being unloaded.

Any complaints regarding manufacturing defects must be reported within 8 days of delivery. We take no responsibility for any assembly errors or defects where the work was not carried out by our specialist staff.

RETURNS

Returns due to manufacturing defects are subject to prior written approval and must be shipped to us properly packaged. Should the contested defects be acknowledged, at the sole discretion of the company, they will be credited at the value actually paid.

PAYMENTS

Only payments made directly to our company headquarters are valid.

Late payments will incur interest at the official bank rate, +7% (Italian Law no. 231 of 09.10.02).

Retention of title clause: the goods shall remain the company's property until the invoice has been paid in full.

COURT OF JURISDICTION

For any disputes, the court of Pordenone (Italy) has jurisdiction.

PRODUCT MODIFICATIONS

The descriptions and technical characteristics of the products shown in this price list are purely indicative and not binding. The company reserves the right to modify the product materials or technical characteristics for technical and/or production reasons without any prior warning.

Sizes are shown in centimetres.

This price list cancels and replaces the previous one and may be modified at any time without prior notice in response to increases in the cost of raw materials or labour, or any other unforeseeable event.

PROPERTY RIGHT

Advertising the furniture supplied using photos or other means is prohibited, without prior written authorisation from DA Group S.r.l.

USE OF TRADEMARK

Customers may not, under any circumstances, use the trademark "Birex", unless otherwise agreed. In the event of a proven breach, DA group s.r.l. reserves the right to take legal action for damages.

For all other terms and conditions of sale, please refer to the related sales paperwork.

The company is not responsible for any printing errors relating to technical features, sizes and prices in this price list.

DA group Srl

Via Mazzini, 3
33070 Maron di Brugnera (PN)
Italy

Reception: +39 0434 619111
Fax: +39 0434 624690
info@birex.it

www.birex.it

