



TXXNTY

BRAND DESIGN

euroluce
— LIGHT OF ITALY —



**indice
-
index**



abstract 180



astral 206



astral colors 216



atlas 148

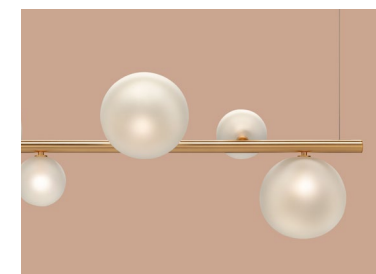

bubbles 6

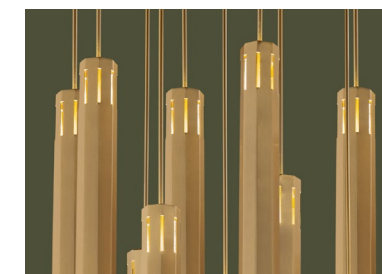

castel 290



corallo 162

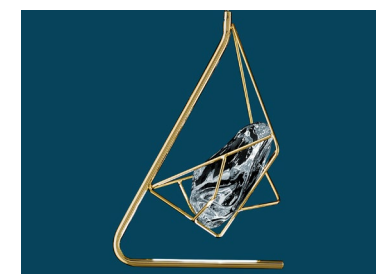

cryrock 250



duo 318



eclissi 54

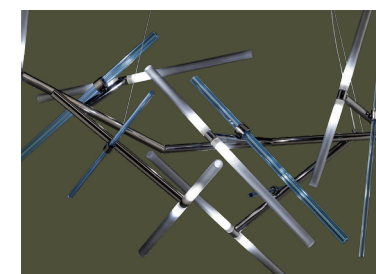

effect 372

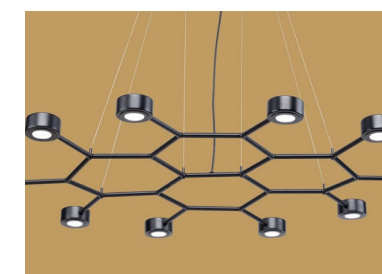

essential 194



girasole **278**

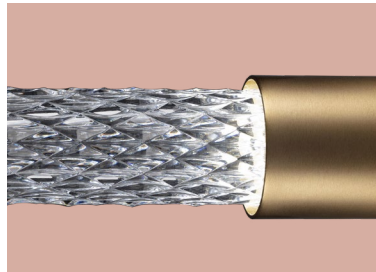

gleam **340**



gocce **230**

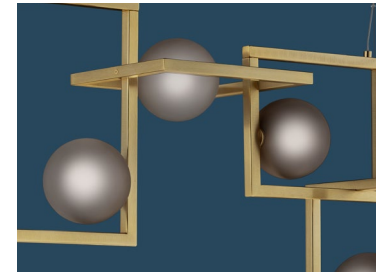

rhythm **306**



rondine **82**



sama **42**

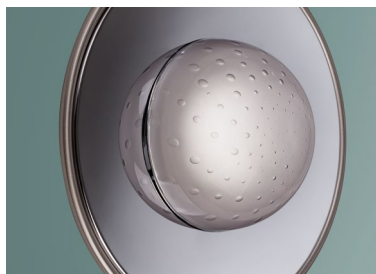

illusione **118**



itala **134**



le perle **68**



sospeso **92**



trama **22**



vector **362**



linea **102**



mikado **350**

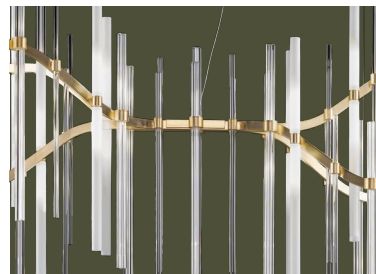

neva **242**



nobody **326**



parachute **126**



profile **262**

bubbles

Bubbles è un invito a liberare l'immaginazione e a sognare ad occhi aperti. Le bolle luminose conferiscono agli ambienti contract una dimensione onirica, trasformando gli spazi in scenari incantati che affascinano i sensi.

STUDIO IN PROJECT

Bubbles is an invitation to free the imagination and to daydream. The luminous bubbles give contract settings a dreamlike dimension, transforming spaces into enchanted scenarios that fascinates the senses.

STUDIO IN PROJECT



Bubbles S6



Bubbles S1



Bubbles LG1





Bubbles LG2



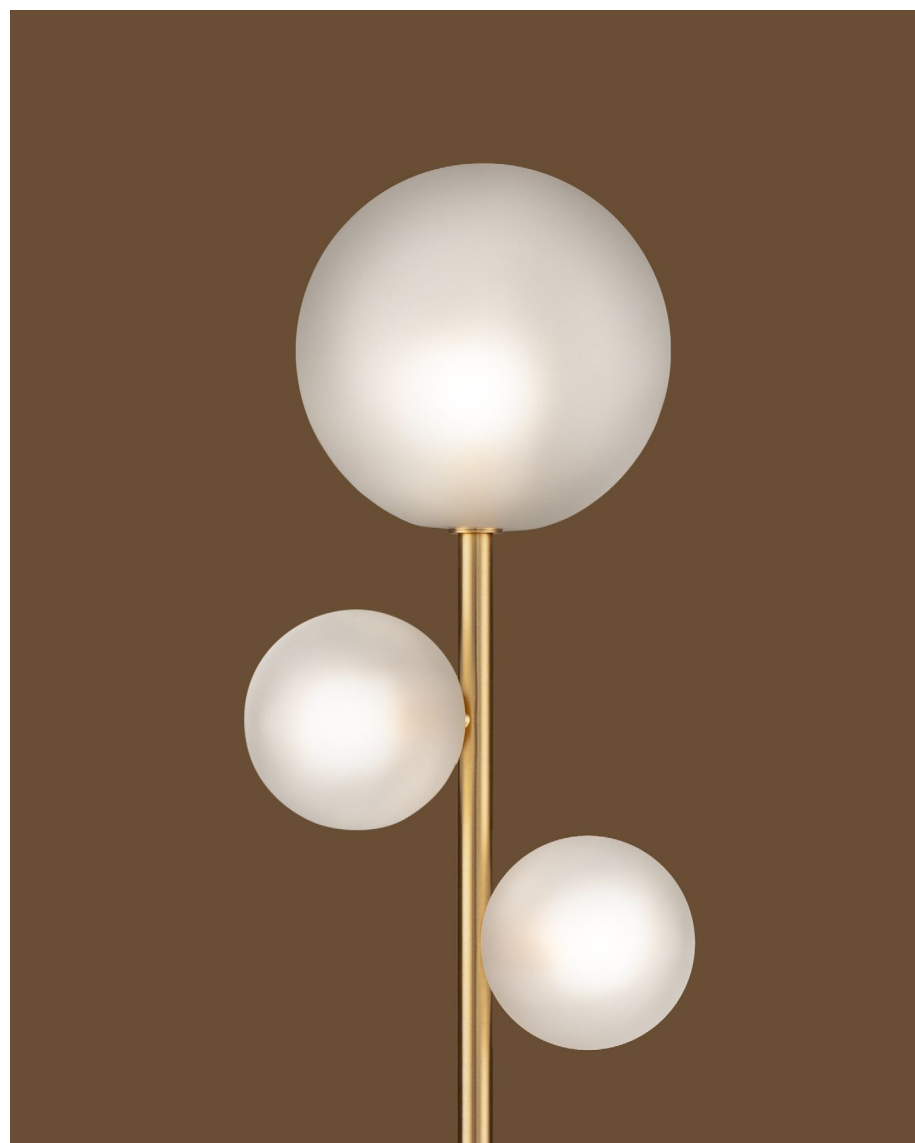



Bubbles A3

Bubbles A2

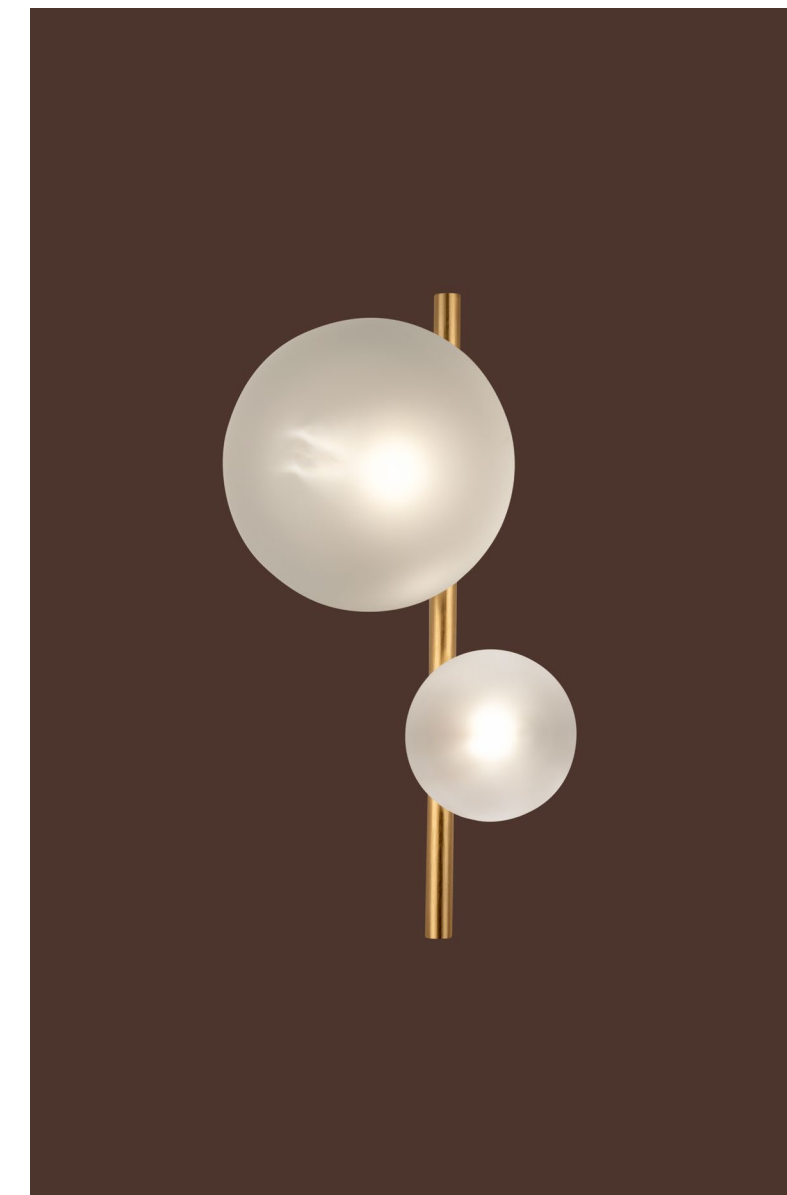

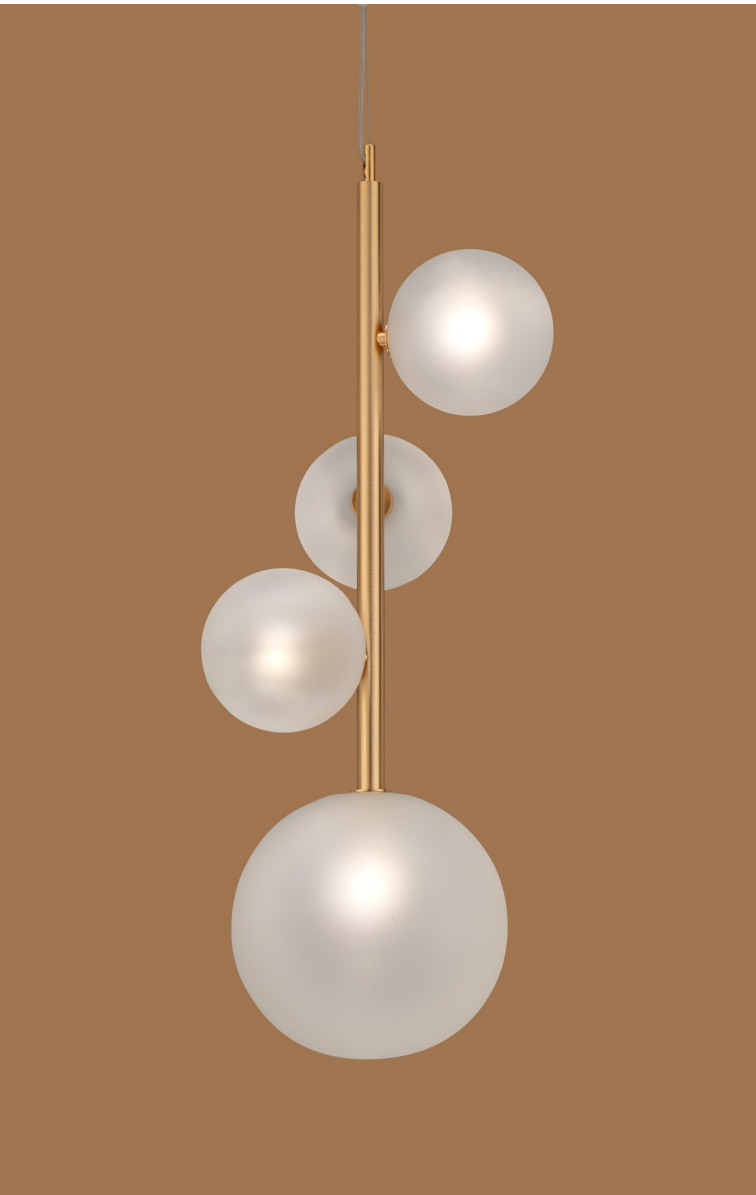

Bubbles S4



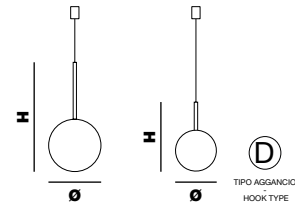

BUBBLES S1 BIG - S1 SMALL

Ø 20 cm | 7,87" / 12 cm | 4,72"
H 36 cm | 14,17" / 28 cm | 11,02"

1 G9 bulb not included

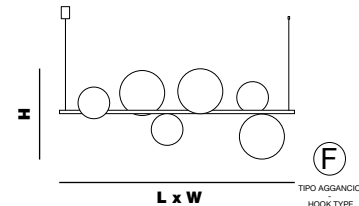

BUBBLES S6

L x W 122 cm x 40 cm | 48,03" x 15,75"
H 40 cm | 15,75"

6 G9 bulb not included

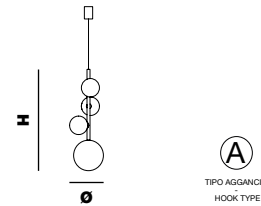

BUBBLES S4

Ø 26 cm | 7,87"
H 68 cm | 26,77"

4 G9 bulb not included

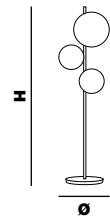

BUBBLES PT3

Ø 30 cm | 11,81"
H 165 cm | 64,69"

3 G9 bulb not included

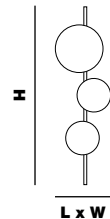

BUBBLES A3

L x W 20,5 cm x 24 cm | 8,07" x 9,45"
H 66 cm | 25,98"

3 G9 bulb not included

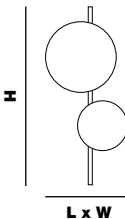

BUBBLES A2

L x W 20,5 cm x 24 cm | 8,07" x 9,45"
H 46 cm | 18,11"

2 G9 bulb not included

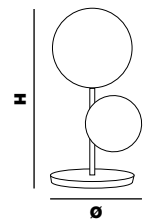

BUBBLES LG2

Ø 21 cm | 8,07"
H 48 cm | 18,90"

2 G9 bulb not included

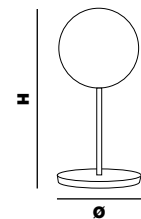

BUBBLES LG1

Ø 20 cm | 7,87"
H 48 cm | 18,90"

1 G9 bulb not included

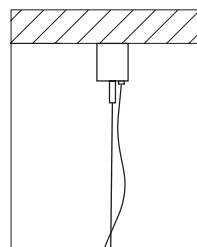

Altezza - Height
MIN 10 cm - 3,93"

Aggancio con rosone o scatola in metallo e tirante in metallo; altezza regolabile (A) - Hook with ceiling cup or metal box and metal cable; adjustable height (A)

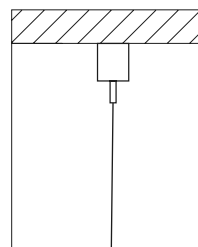

Altezza - Height
MIN 10 cm - 3,93"

Aggancio con rosone o scatola a soffitto e cavo di alimentazione; altezza regolabile (D) - Hook with ceiling cup and power cord; adjustable height (D)

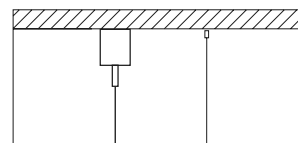

Altezza - Height
MIN 10 cm - 3,93"

Aggancio con rosone, tiranti e tasselli a soffitto; altezza regolabile (F) - Hook with ceiling cup, metal cables and ceiling cable gripper; adjustable height (F)



bubbles

Studio in Project

Particolari - Details

Strutture in ferro realizzate artigianalmente su disegno. Sfere in borosilicato con finitura satinata. Boccole portalampadine in ottone tornito. Per qualsiasi richiesta o differente versione non esitate a contattarci.

Handcrafted iron structures made on our drawing. Borosilicate spheres with satin finish. Led holder bushings made of turned brass. For any inquiries or different versions, please do not hesitate to contact us.

Metalli - Metals

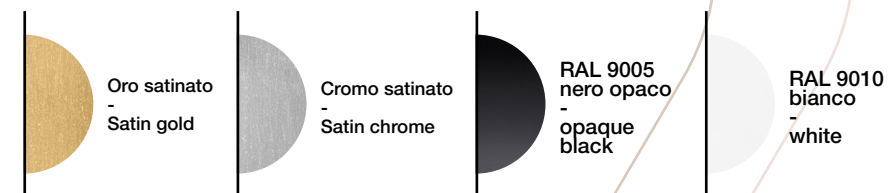

Vetro - Glass

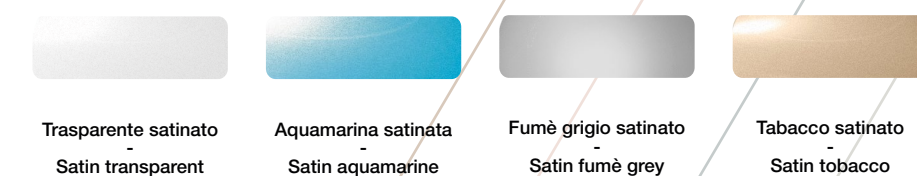

* Altre finiture e colori su richiesta - Other finishes and colors on request

trama

Ispirato dall'intricato intreccio dei tessuti, Trama combina la trasparenza e la purezza del vetro con la struttura sofisticata dei tubi dritti. Ogni elemento, meticolosamente lavorato, richiama la delicatezza dei fili intrecciati, creando un gioco di luci e ombre che danza nello spazio.

STUDIO IN PROJECT

Inspired by the intricate weaving of textiles, Trama combines the transparency and purity of glass with the sophisticated structure of straight tubes. Each meticulously crafted element recalls the delicacy of woven threads, creating a play of light and shadow that dances through space.

STUDIO IN PROJECT



Trama S8 Grid

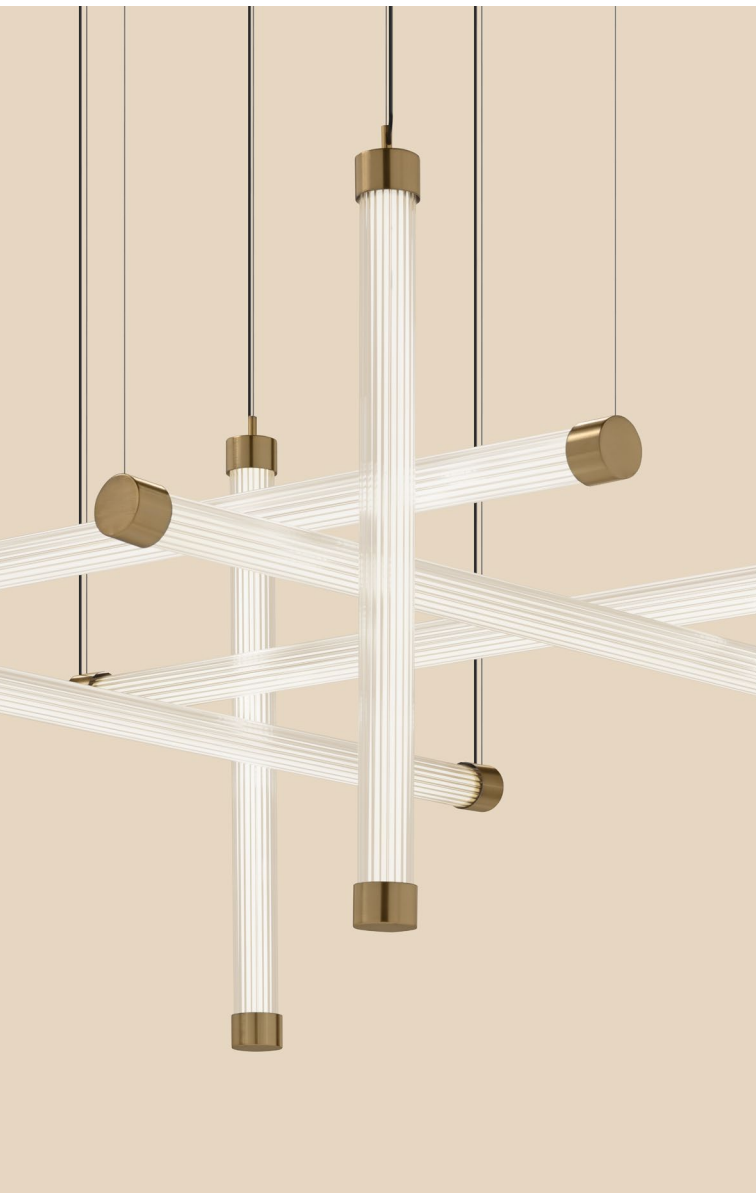

Trama project n°2 S8 Grid



Trama project





Trama S9

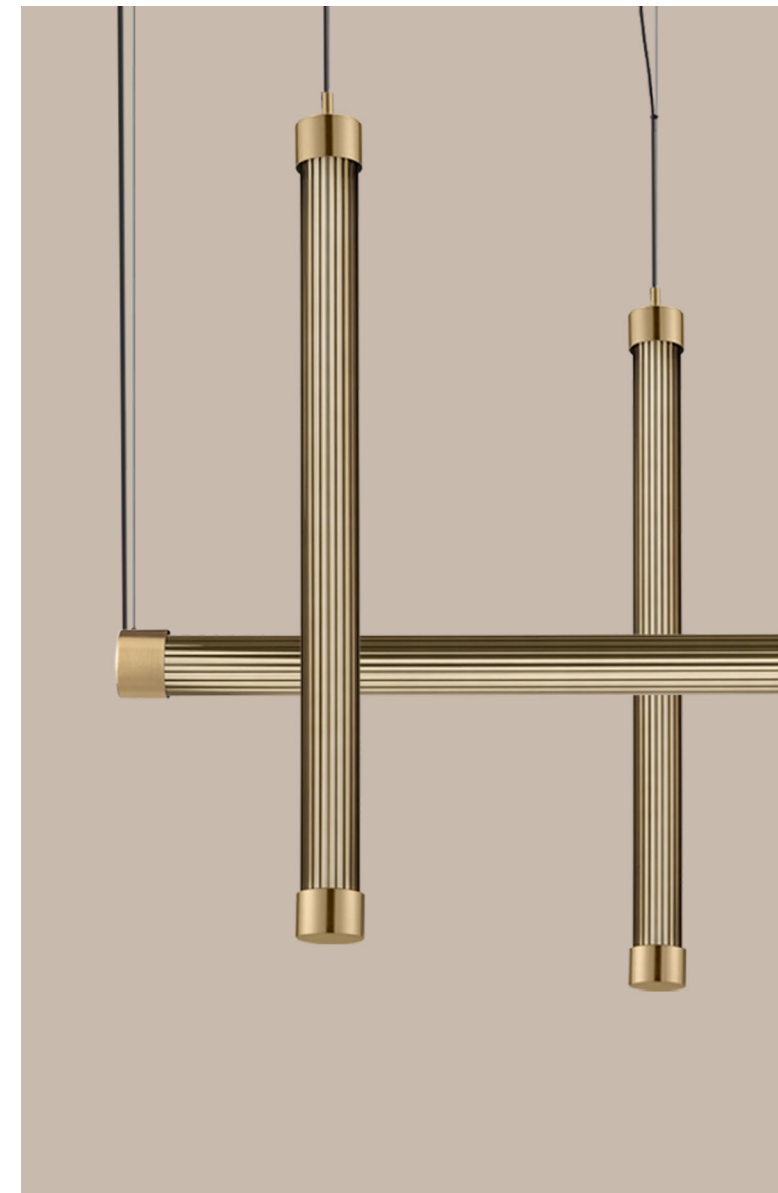





Trama wall lamp 120



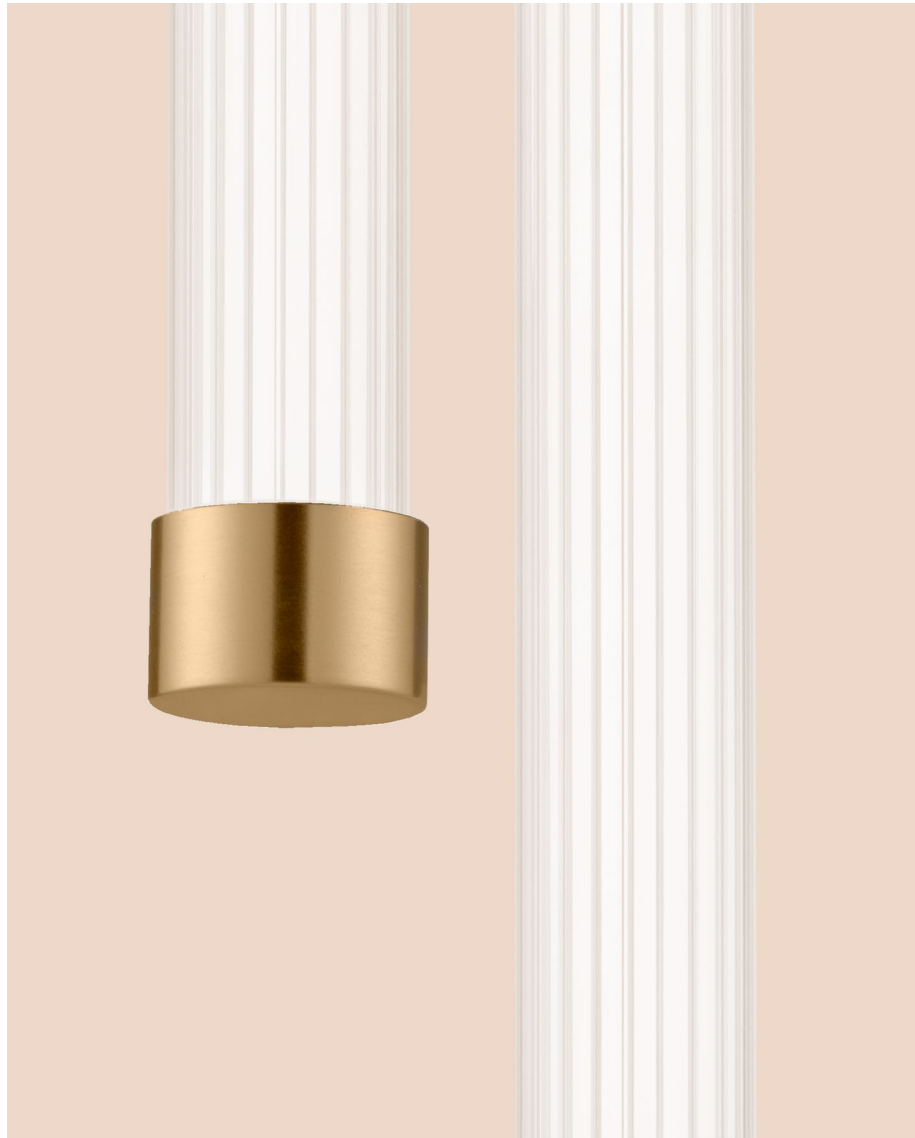

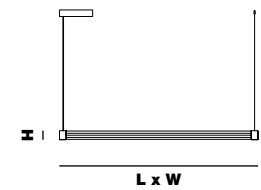

TRAMA S1 A

L x W 126 cm x 6 cm | 49,61" x 2,36"
H 6 cm | 2,36"

360° neon flex 21,6W - 3000°K - 24 Vdc - SMD 2835T
2536,8 lm - life time 50.000 hrs - Dimmable: yes

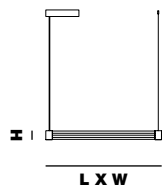

TRAMA S1 B

L x W 75 cm x 6 cm | 29,53" x 2,36"
H 6 cm | 2,36"

360° neon flex 12,6W - 3000°K - 24 Vdc - SMD 2835T
1480 lm - life time 50.000 hrs - Dimmable: yes

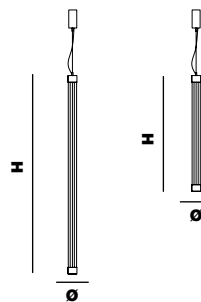

TRAMA S1 C - S1 D

Ø 6 cm | 2,36"
H 127 cm | 50" / 76 cm | 29,92"

360° neon flex 21,6W/12,6W - 3000°K - 24 Vdc - SMD 2835T - 2536,8 lm/1480 lm - life time 50.000 hrs - Dimmable: yes

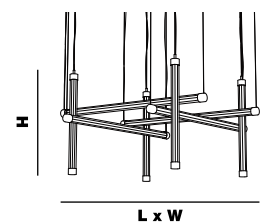

TRAMA S8 GRID

L x W 126 cm x 126 cm | 49,61" x 49,61"
H 76 cm | 29,92"

8 - 360° neon flex 137W - 3000°K - 24 Vdc - SMD 2835T
16068 lm - life time 50.000 hrs - Dimmable: yes

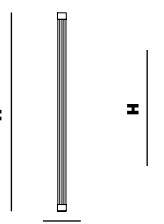

TRAMA WALL LAMP 120 - 70

L x W 6 cm x 8 cm | 2,36" x 3,15"
H 126 cm | 49,61" / 75 cm | 29,53"

360° neon flex 21,6W/12,6W - 3000°K - 24 Vdc - SMD 2835T - 2536,8 lm/1480 lm - life time 50.000 hrs - Dimmable: yes

*standard version comes with remote LED driver.
You can request a version with integrated LED driver.

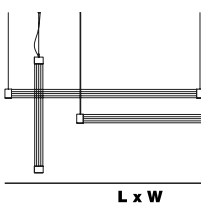

TRAMA S3

L x W 160 cm x 33 cm | 62,99" x 12,99"
H 76 cm | 29,92"

3 - 360° neon flex 55,8W - 3000°K - 24 Vdc - SMD 2835T
6353,6 lm - life time 50.000 hrs - Dimmable: yes

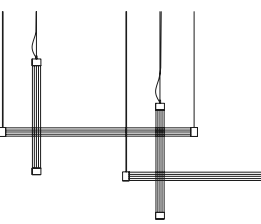

TRAMA S5

L x W 210 cm x 50 cm | 82,67" x 19,68"
H 86 cm | 33,85"

5 - 360° neon flex 81W - 3000°K - 24 Vdc - SMD 2835T
9513,6 lm - life time 50.000 hrs - Dimmable: yes

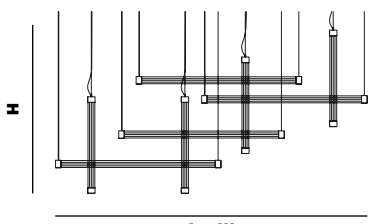

TRAMA S8

L x W 230 cm x 83 cm | 90,55" x 32,67"
H 114 cm | 44,88"

8 - 360° neon flex 137W - 3000°K - 24 Vdc - SMD 2835T
16068 lm - life time 50.000 hrs - Dimmable: yes

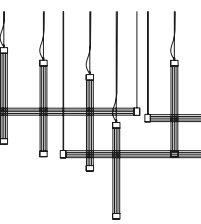

TRAMA S9

L x W 240 cm x 94 cm | 94,48" x 37"
H 114 cm | 44,88"

9 - 360° neon flex 140,5W - 3000°K - 24 Vdc - SMD 2835T
16490,4 lm - life time 50.000 hrs - Dimmable: yes

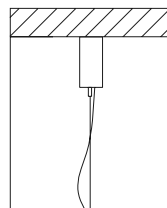

Altezza - Height
MIN 30 cm - 11,8"
Aggancio con rosone o scatola in metallo e tirante in metallo; altezza regolabile (A)
- Hook with ceiling cup or metal box and metal cable; adjustable height (A)
* rosone cilindrico Ø7 H16 cm
- cylindrical metal box Ø7 H16 cm

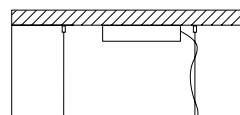

Altezza - Height
MIN 24 cm - 9,44"
Aggancio con rosone, tiranti e tasselli a soffitto; altezza regolabile (F) - Hook with ceiling cup, metal cables and ceiling cable gripper; adjustable height (F)
* rosone scatola rettangolare L15 W7 H3,5 cm - rectangular metal box L15 W7 H3,5 cm



Aggancio da definire (L)
Hooks to be defined (L)

trama

Studio in Project

Particolari - Details

Trama è una collezione composta da elementi singoli in differenti lunghezze ma che affiancati possono strutturare progetti ad-hoc anche di estese dimensioni. Ricreano nell'aria una trama luminosa personalizzabile.

Gli elementi di Trama sono in borosilicato trasparente o decorato e all'estremità sono inserite le bocche in alluminio tornito e le cover in metallo stampato.

L'elemento luminoso è un Neonflex 360° ed illumina il tubo in borosilicato per tutta la sua lunghezza.

Trama è già disponibile nelle misure indicate nei disegni. Per qualsiasi richiesta o differente versione non esitate a contattarci.

Trama is a collection made up of single elements in different lengths but which, when placed side by side, can create ad hoc projects even of large sizes. They recreate a customizable light pattern in the air.

Trama's elements are made of transparent or colored borosilicate glass with turned aluminum bushings and molded metal covers at the ends.

The light source is a 360° Neonflex, that lights up the borosilicate tube along its whole length.

Trama is already available in the sizes shown in the drawings. Do not hesitate to contact us for any request or different version.

Metalli - Metals



Oro satinato
- Satin gold



Oro lucido
- Shiny gold

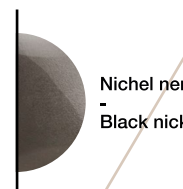

Nichel nero
- Black nickel



RAL 9005 nero opaco
- opaque black



altri RAL su richiesta
- other RAL on request

Vetro - Glass



Trasparente
- Transparent



Rosaline



Acquamarine
- Aquamarine



Fumè grigio
- Fumè grey



Tabacco
- Tobacco

* Altre finiture e colori su richiesta - Other finishes and colors on request



sama

*Una perfetta fusione tra arte e tradizione.
Ispirata alla danza Sufi riproduce la forma sinuosa del
derviscio rotante, creando una sensazione di movimento.*

DANIEL BECKER

*A perfect fusion of art and tradition.
Inspired by Sufi dance, it reproduces the sinuous shape of
the rotating dervish, creating a feeling of movement*

DANIEL BECKER





Sama medium



Sama small





Sama large



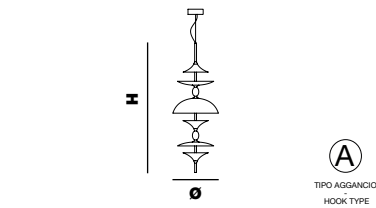

SAMA large

Ø 50 cm | 19,69"
H 140 cm | 55,12"

3 spotted 30W - 4000°K - 220 Vdc - 3000 lm
life time 40.000 hrs - Dimmable: yes

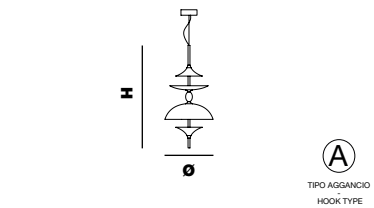

SAMA medium

Ø 50 cm | 19,69"
H 100 cm | 39,37"

2 spotted 20W - 4000°K - 220 Vdc - 2000 lm
life time 40.000 hrs - Dimmable: yes

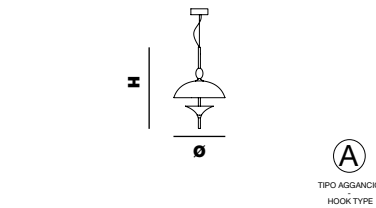

SAMA small

Ø 50 cm | 19,69"
H 80 cm | 31,50"

1 spotted 10W - 4000°K - 220 Vdc - 1000 lm
life time 40.000 hrs - Dimmable: yes

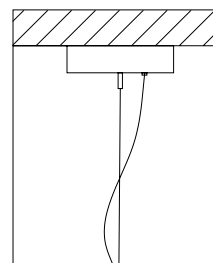

Altezza - Height
MIN 18 cm - 7.08"

Aggancio con rosone o scatola in metallo
e tirante in metallo; altezza regolabile (A)
- Hook with ceiling cup or metal box and
metal cable; adjustable height (A)

sama

Daniel Becker

Particolari - Details

Componenti in metallo e alluminio torniti su disegno personalizzato. Cupole in vetro tecnico curvato e sabbiato. Diffusori in plexiglass opalino. Per qualsiasi richiesta o differente versione non esitate a contattarci.

Metal and aluminum components turned on custom drawing. Domes in curved and sandblasted technical glass. Opal plexiglass diffusers. Do not hesitate to contact us for any request or different version.

Metalli - Metals

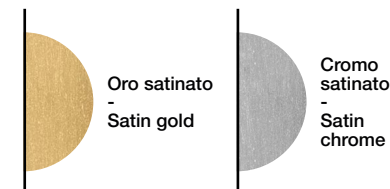

Vetro - Glass



Plexiglass



* Specifiche agganci - Info on hooks pag. 345 *

* Altre finiture e colori su richiesta - Other finishes and colors on request - see pag. 347-348 *

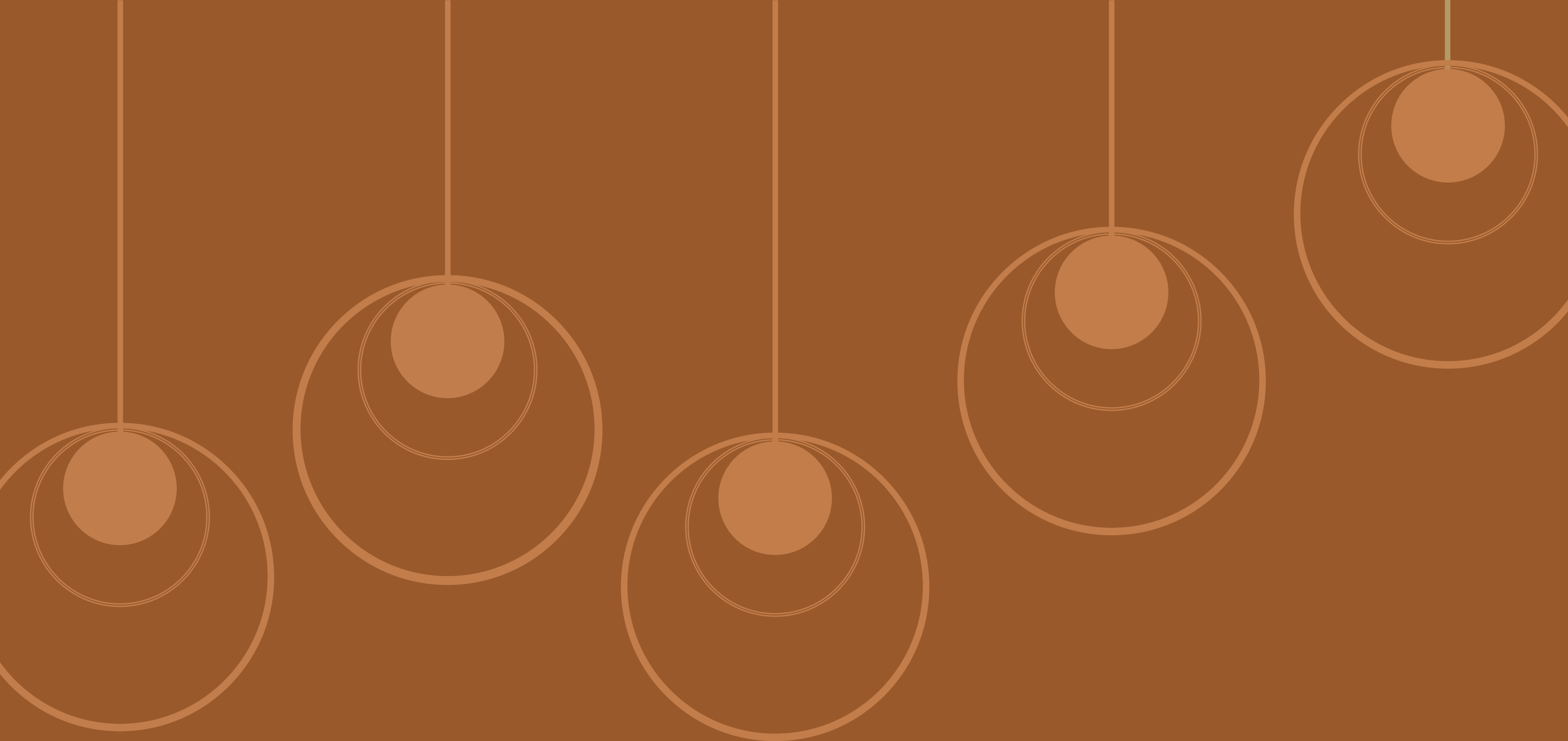

eclissi

*Ispirata alla bellezza e luminosità della luna.
La sua forma circolare è composta da diversi cerchi, ricorda
l'aspetto dell'eclissi lunare*

STUDIO IN PROJECT

*Inspired by the beauty and brightness of the moon.
Its circular shape is composed of several circles, reminiscent
of the appearance of the lunar eclipse.*

STUDIO IN PROJECT

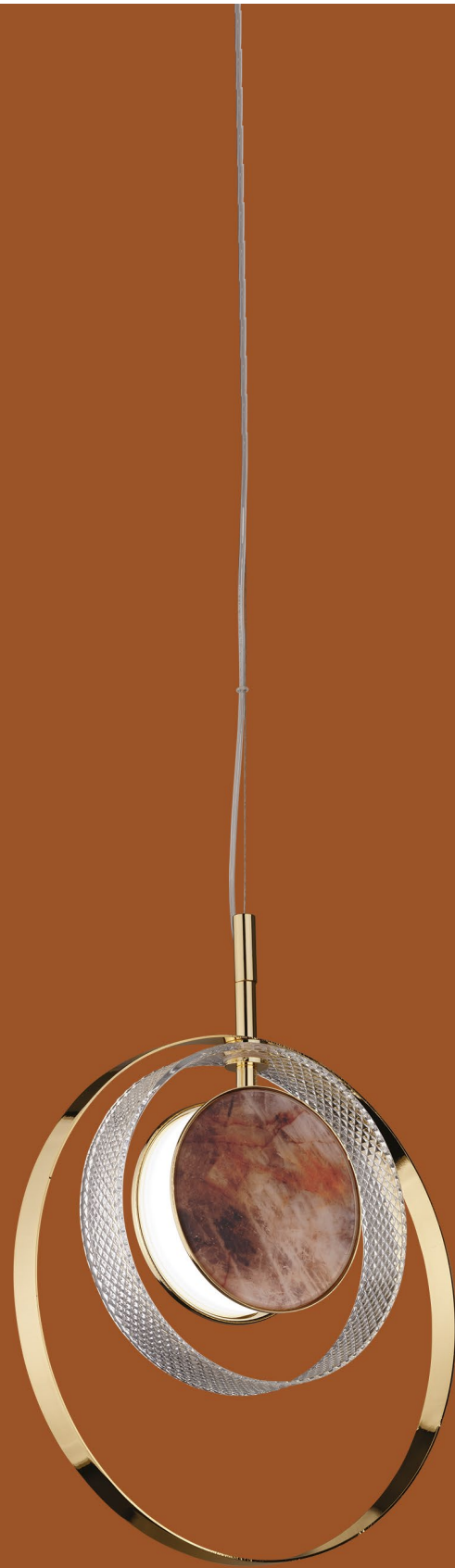

quartzite brown



calacatta natural



calacatta electric silver



Eclissi S1





Eclissi S1

Eclissi wall lamp



Eclissi S1



tan grey

Eclissi lamp



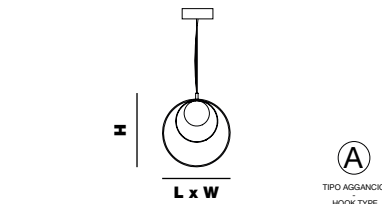

ECLISSI S1

L x W 30 X 7 cm | 11,81" x 2,76"
H 37 cm | 14,57"

Stripled 16W - 3000°K - 24 Vdc - 2400 lm
 life time 50.000 hrs - SMD Type 2835
 Dimmable: yes

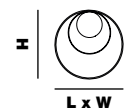

ECLISSI wall lamp

L x W 30 X 7 cm | 11,81" x 2,76"
H 30 cm | 11,81"

Stripled 16W - 3000°K - 24 Vdc - 2400 lm
 life time 50.000 hrs - SMD Type 2835
 Dimmable: yes

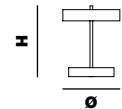

ECLISSI lamp

Ø 22 cm | 8,66"
H 25 cm | 9,84"

Stripled 16W - 3000°K - 24 Vdc - 2400 lm
 life time 50.000 hrs - SMD Type 2835
 Dimmable: yes

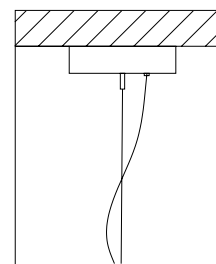

Altezza - Height
 MIN 18 cm - 7.08"



Aggancio con rosone o scatola in metallo e tirante in metallo; altezza regolabile (A)
 - Hook with ceiling cup or metal box and metal cable; adjustable height (A)

eclissi

Studio in Project

Particolari - Details

Realizzato in alluminio e metallo. Anelli in vetro con effetto diamantato molati a mano. Riproduzione di preziosi marmi su dischi in vetro grazie a trasferimento digitale.

Made of aluminum and metal. Glass rings with hand-cut diamond effect. Reproduction of precious marbles on glass disks thanks to digital transfer.

Metalli - Metals

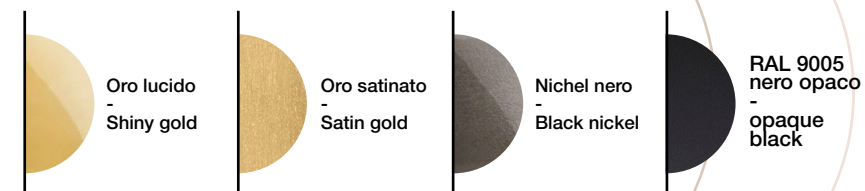

Vetro - Glass

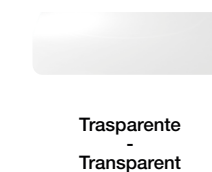

Trasparente
 -
 Transparent

Vetro marmorizzato - Marbled glass



Tan grey

Calacatta electric silver

Calacatta natural

Quarzite brown

* Specifiche agganci - Info on hooks pag. 345 *

* Altre finiture e colori su richiesta - Other finishes and colors on request - see pag. 347-348 *



le perle

Un apparato dalla natura complessa ma dall'aspetto semplice. Proprio come una sequenza di perle indossate in una preziosa collana.

ALBERTO GHIRARDELLO

*A complex but simple-looking apparatus.
Just like a sequence of pearls worn in a precious necklace.*

ALBERTO GHIRARDELLO



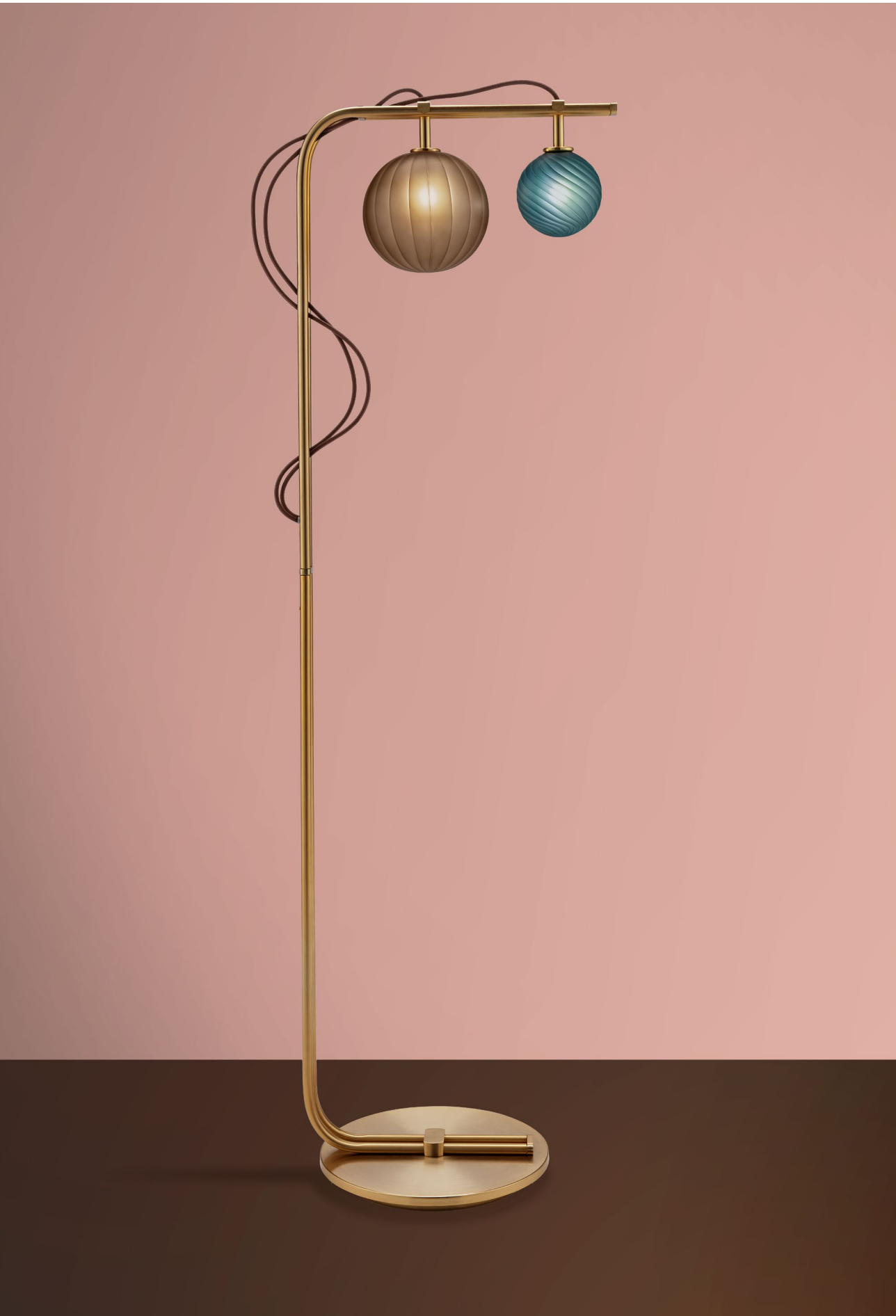

Le Perle floor lamp



Le Perle wall lamp



Le Perle project





Le Perle big + small



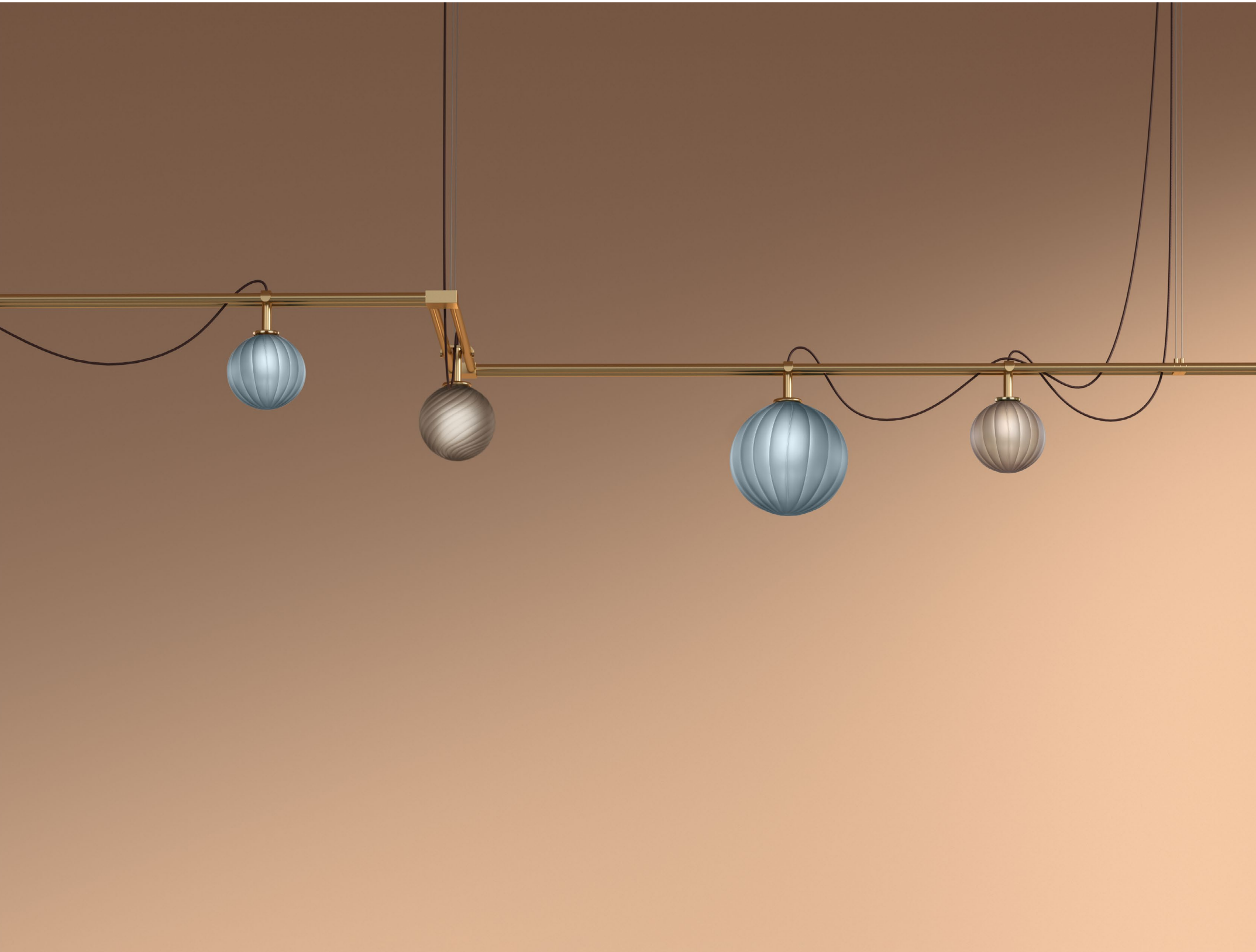

Le Perle project

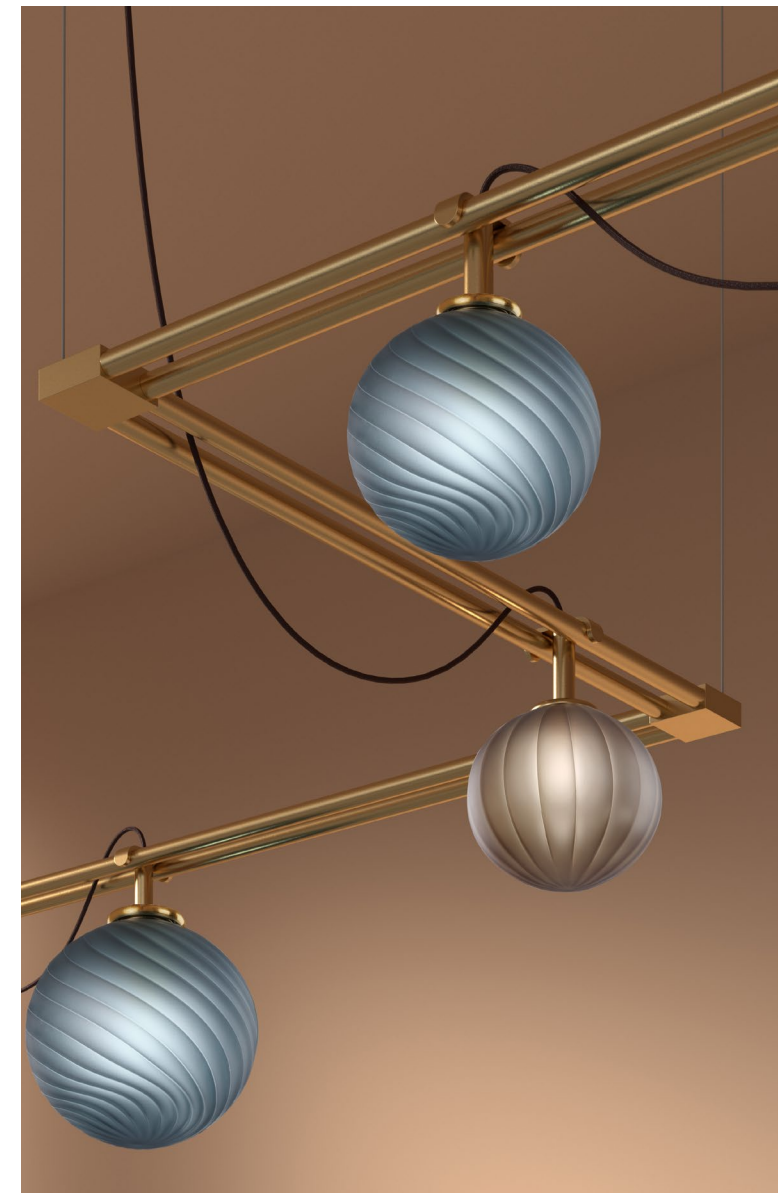

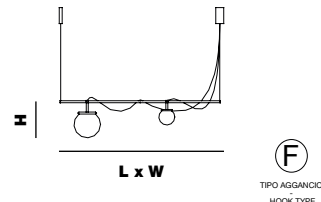

LE PERLE big

L x W 120 X 18 cm | 47,24" x 7,09"

H 28 cm | 11,02"

2 bulb G9 x max 7W - 220 Vdc

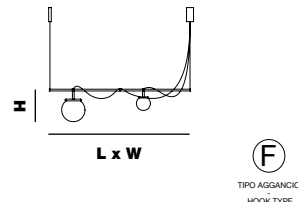

LE PERLE medium

L x W 100 X 18 cm | 39,37" x 7,09"

H 28 cm | 11,02"

2 bulb G9 x max 7W - 220 Vdc

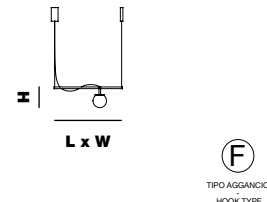

LE PERLE small

L x W 60 X 12 cm | 23,62" x 4,72"

H 18 cm | 7,09"

1 bulb G9 x max 7W - 220 Vdc

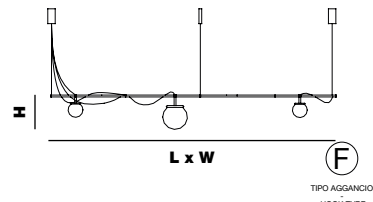

LE PERLE big + small

L x W 180 x 18 cm | 70,87" x 7,09"

H 28 cm | 11,02"

3 bulb G9 x max 7W - 220 Vdc

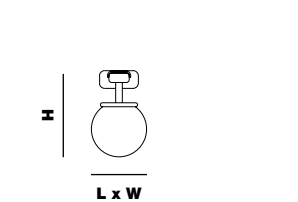

LE PERLE wall lamp

L x W 13 x 25 cm | 5,12" x 9,84"

H 23 cm | 9,06"

1 bulb G9 x max 7W - 220 Vdc

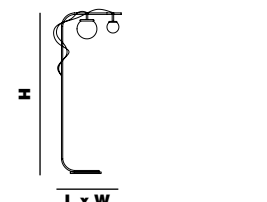

LE PERLE floor lamp

L x W 46 x 40 cm | 18,11" x 15,75"

H 160 cm | 62,99"

2 bulb G9 x max 7W - 220 Vdc

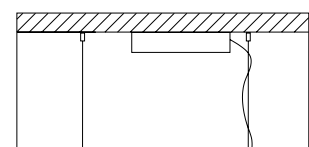

Altezza - Height
MIN 24 cm - 9.44"



Aggancio con rosone, tiranti e tasselli a soffitto; altezza regolabile (F) - Hook with ceiling cup, metal cables and ceiling cable gripper; adjustable height (F)

le perle

Alberto Ghirardello

Particolari - Details

Strutture realizzate su disegno. Sistema modulare che consente configurazioni più estese. Richiedere progetto ad hoc che si adatti al meglio ai vostri spazi. Sfere in borosilicato con diverse texture possibili: rigato dritto, rigato ritorto. Per qualsiasi richiesta o differente versione non esitate a contattarci.

Structures made on drawing. Modular system that allows larger configurations. Request ad hoc project that best suits your spaces. Borosilicate spheres with different possible textures: straight ribbed, twisted ribbed. For any request or different version please contact us.

Metalli - Metals

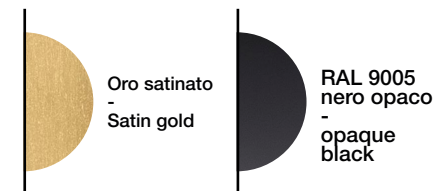

Vetro - Glass



* Specifiche agganci - Info on hooks pag. 345 *

* Altre finiture e colori su richiesta - Other finishes and colors on request - see pag. 347-348 *

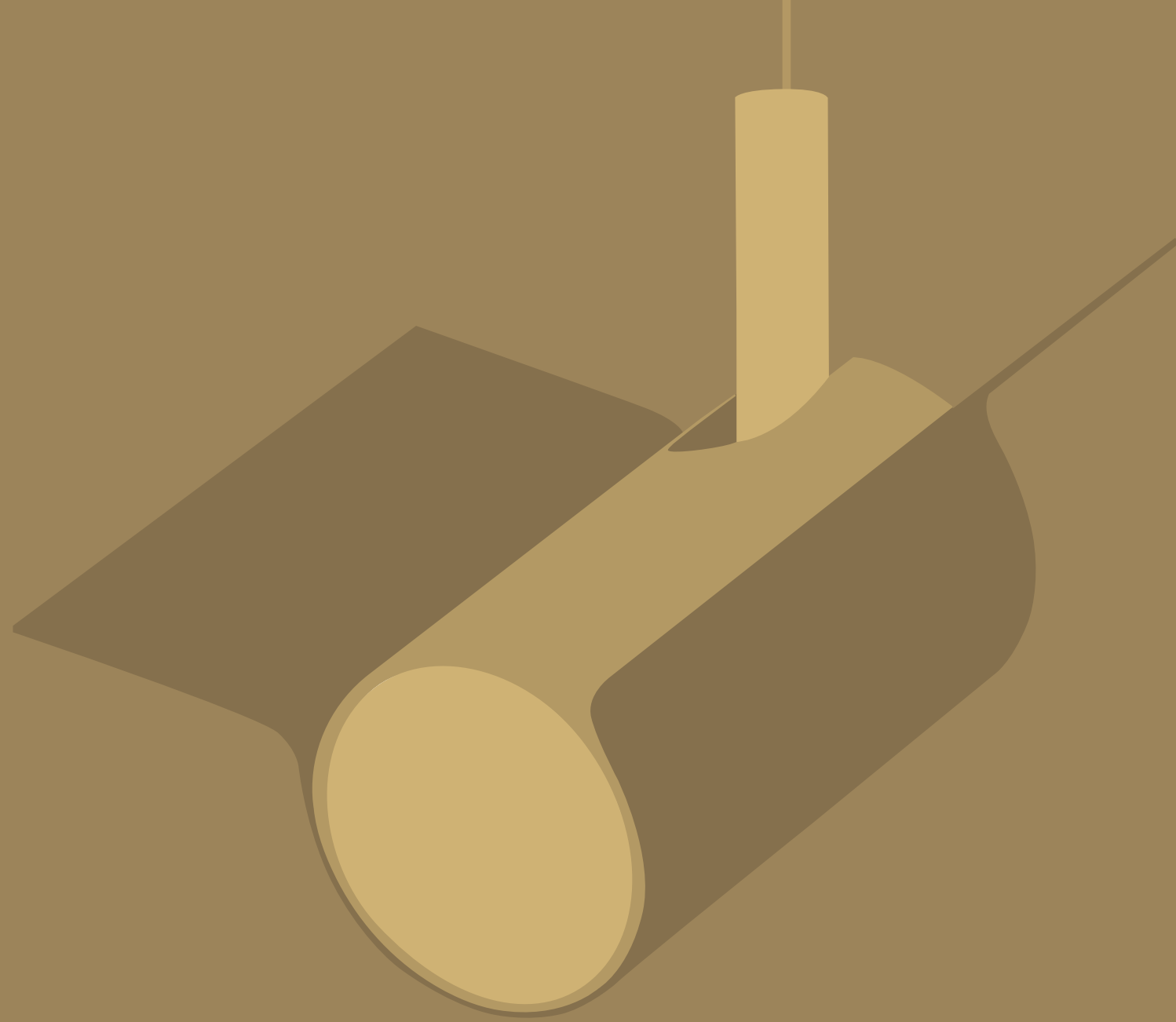

rondine

*Nato dall'idea di leggerezza e sostenibilità
rondine comunica un messaggio molto preciso:
semplicità e attenzione al dettaglio nel rispetto dell'uomo
moderno, consapevole dell'ambiente.*

SIMONE DI LIDDO

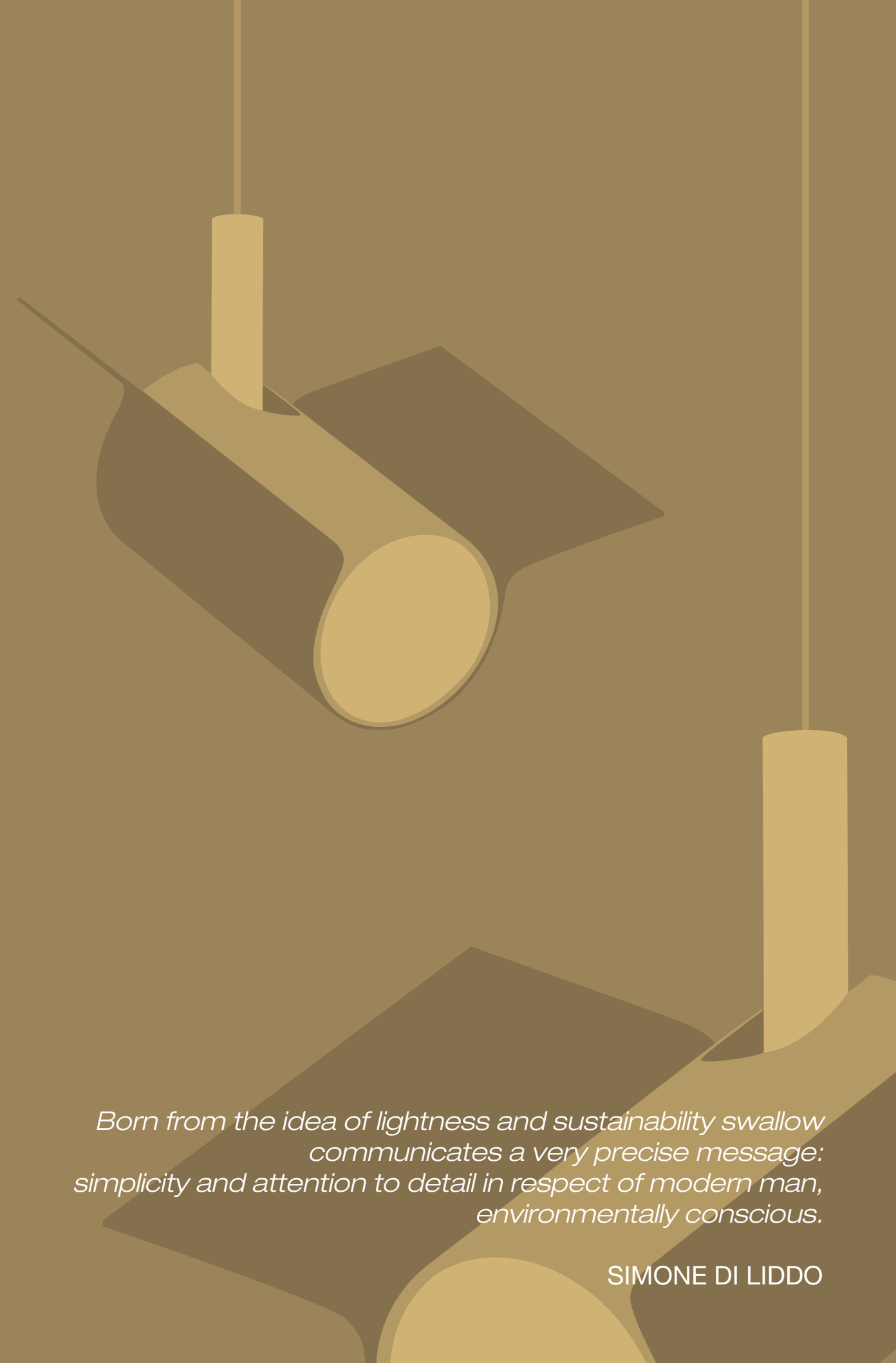

*Born from the idea of lightness and sustainability swallow
communicates a very precise message:
simplicity and attention to detail in respect of modern man,
environmentally conscious.*

SIMONE DI LIDDO



Rondine big - Rondine small





Rondine big - Rondine small

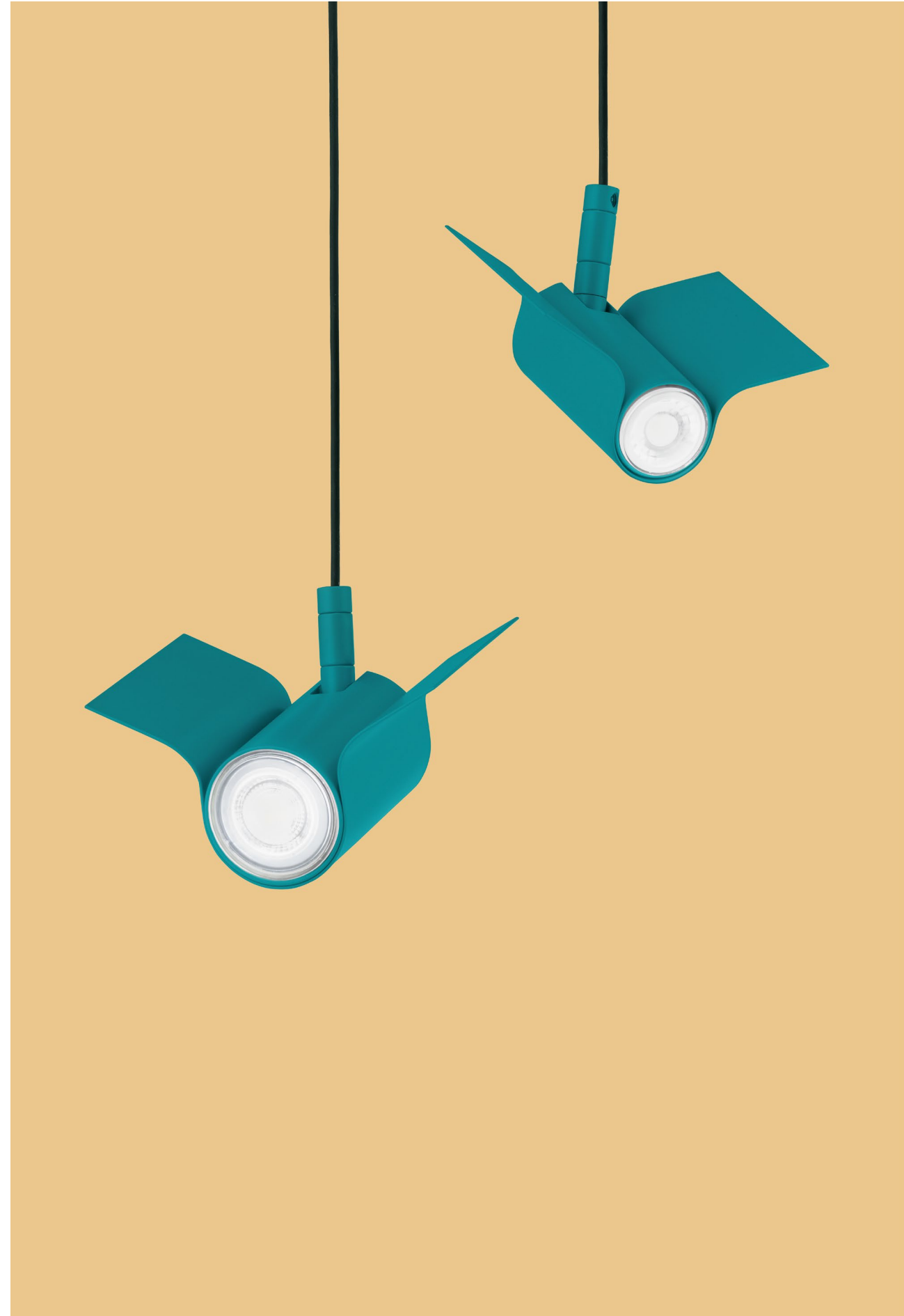



Rondine project

Rondine big - Rondine small



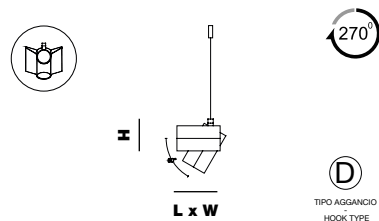

RONDINE big

L x W 11 X 15 cm | 4,33" x 5,91"

H 9 cm | 3,54"

1 GU10 MR16 bulb 4W - 4000°K - 220 Vdc
450 lm - life time 15.000 hrs - Dimmable: no

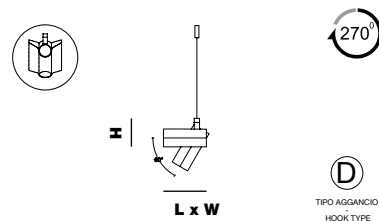

RONDINE small

L x W 11 X 12 cm | 4,33" x 4,72"

H 8 cm | 3,15"

1 GU10 MR11 bulb 4W - 4000°K - 220 Vdc
220 lm - life time 30.000 hrs - Dimmable: no

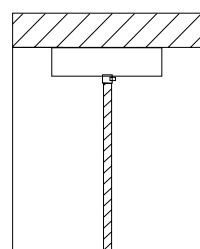

Altezza - Height
MIN 18 cm - 7.08"

D Aggancio con rosone o scatola a soffitto e cavo di alimentazione; altezza regolabile (D) - Hook with ceiling cup and power cord; adjustable height (D)



Faretto regolabile fino a 270 gradi - Adjustable spotlight up to 270 degrees

* Specifiche agganci - Info on hooks pag. 345 *

rondine

Simone Di Liddo

Particolari - Details

Rondine ha un corpo in alluminio tornito su disegno e ali in metallo. Lo snodo consente il movimento in verticale e orizzontale. Sono proposte due dimensioni differenti di Rondine. È possibile creare conformazioni più articolate e richiedere un progetto ad hoc che si adatti al meglio ai vostri spazi.

Rondine has a turned aluminium body and metal wings. The joint allows the movement in vertical and horizontal. There are two different sizes of Rondine. It's possible to create more articulated conformations and request an ad hoc project that best suits your spaces.

Metalli - Metals

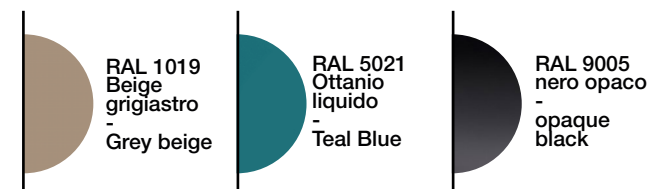

* Altre finiture e colori su richiesta - Other finishes and colors on request - see pag. 347-348 *

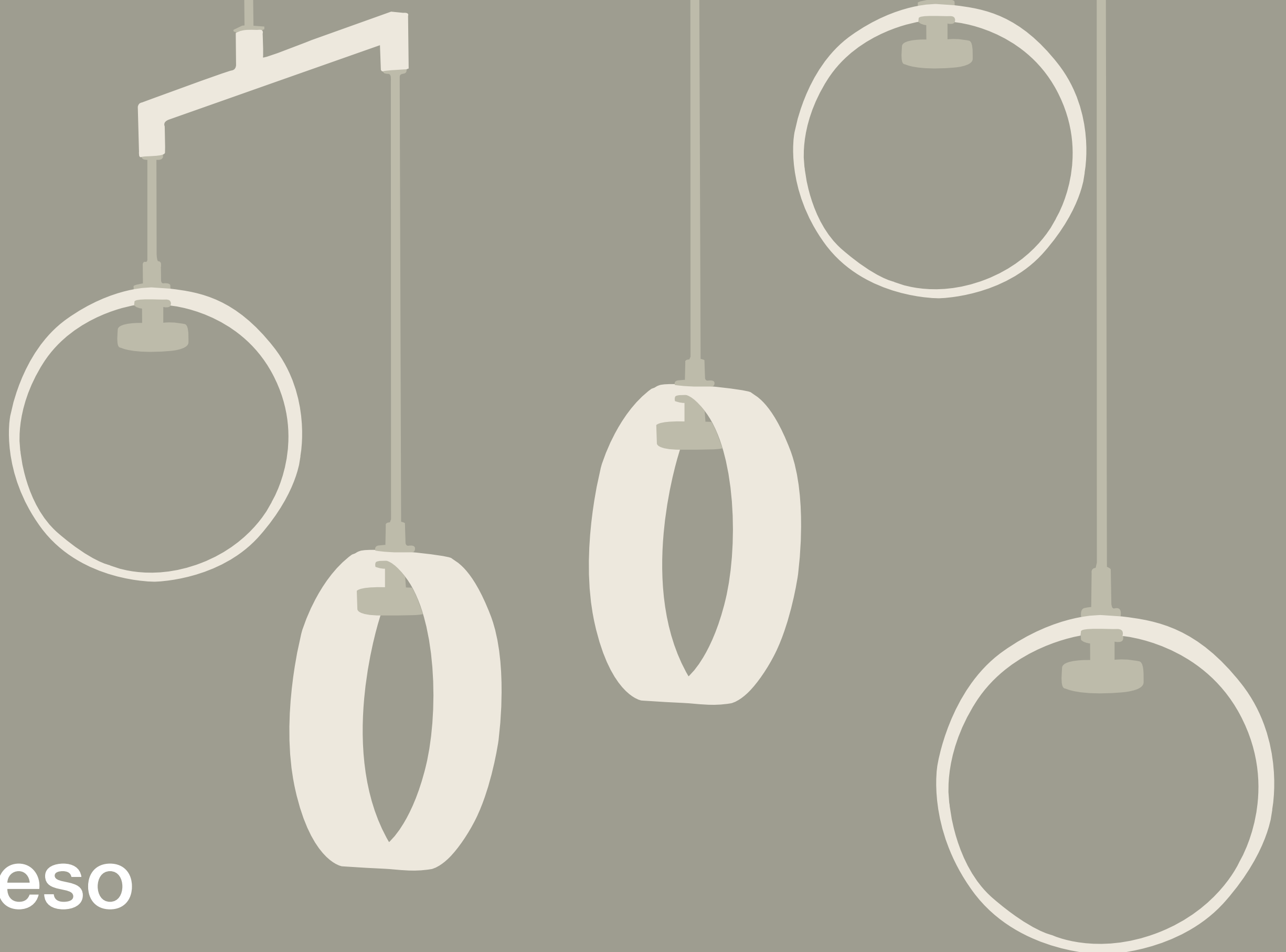

sospeso

Un'opera d'arte illuminante che sembra fluttuare nell'aria, regala una sensazione di leggiadria e armonia.

STUDIO IN PROJECT

An illuminating work of art that seems to float in the air, gives a feeling of gracefulness and harmony.

STUDIO IN PROJECT

Sospeso S3



Sospeso S5



Sospeso wall lamp



Sospeso lamp





Sospeso S1 - colored version



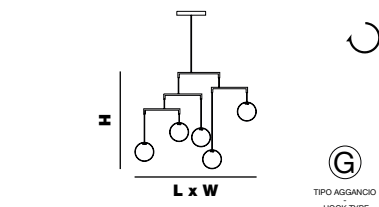

SOSPESO S5

L x W 120 x 5 cm | 47,24" x 1,97"
H 110 cm | 43,31"

5 spotted 16W - 4000°K - 12 Vdc - SMD 5630
 1400 lm - life time 30.000 hrs - Dimmable: yes

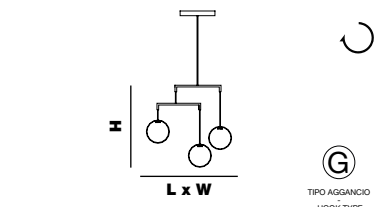

SOSPESO S3

L x W 72 x 5 cm | 28,35" x 1,97"
H 74 cm | 29,13"

3 spotted 9W - 4000°K - 12 Vdc - SMD 5630
 840 lm - life time 30.000 hrs - Dimmable: yes

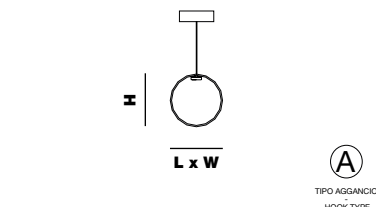

SOSPESO S1

L x W 20 x 5 cm | 7,87" x 1,97"
H 34 cm | 13,19"

1 spotted 3W - 4000°K - 12 Vdc - SMD 5630
 280 lm - life time 30.000 hrs - Dimmable: yes

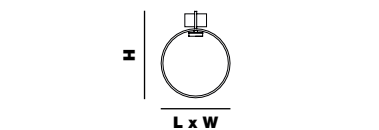

SOSPESO wall lamp

L x W 20 x 11 cm | 7,87" x 4,33"
H 28 cm | 11,02"

1 spotted 3W - 4000°K - 12 Vdc - SMD 5630
 280 lm - life time 30.000 hrs - Dimmable: yes

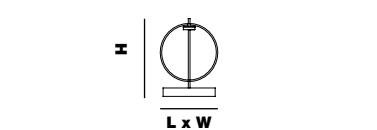

SOSPESO lamp

L x W 20 x 10 cm | 7,87" x 3,94"
H 35 cm | 13,78"

1 spotted 3W - 4000°K - 12 Vdc - SMD 5630
 280 lm - life time 30.000 hrs - Dimmable: yes

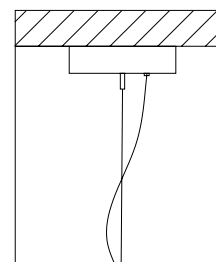

Altezza - Height
 MIN 18 cm - 7,08"

Aggancio con rosone o scatola in metallo e tirante in metallo; altezza regolabile (A)
 - Hook with ceiling cup or metal box and metal cable; adjustable height (A)

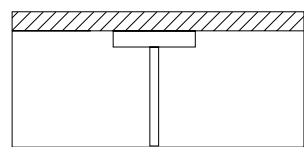

Altezza - Height
 MIN 15 cm - 5,91"

Aggancio con altezza fissa. Specificare altezza desiderata. Altezza non regolabile
 - Hook with fixed height. Specify desired height. Non-adjustable height (G)



Possibilità rotazione seguendo istruzioni montaggio - Rotation possible following assembly instructions

* Specifiche agganci - Info on hooks pag. 345 *

sospeso

Studio in Project

Particolari - Details

Strutture realizzate artigianalmente. Faretti in alluminio tornito. È possibile ruotare le componenti di Sospeso S5 e S3 seguendo le istruzioni, in modo da cambiarne la configurazione nello spazio. Le dimensioni indicate in scheda si riferiscono a Sospeso con configurazione piana. Anelli in vetro con effetto diamantato molato a mano.

Structures made by hand. Spotlights in turned aluminium. You can rotate the components of Sospeso S5 and S3, following instructions, so as to change the configuration in space. The dimensions indicated on the card refer to Sospeso with flat configuration. Glass rings with hand-cut diamond effect.

Metalli - Metals

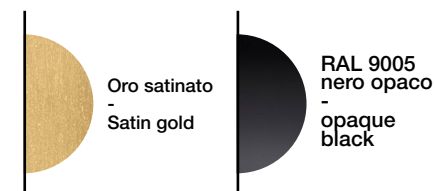

Vetro - Glass



* Altre finiture e colori su richiesta - Other finishes and colors on request - see pag. 347-348 *

The background features a complex, abstract pattern of blue lines and shapes. It consists of several vertical columns of thin, parallel lines, some of which are connected by horizontal bars. There are also larger, solid blue rectangular blocks and a few thin horizontal lines scattered throughout the composition. The overall effect is a sense of depth and movement, with lines appearing to intersect and overlap.

linea

Una linea continua con direzioni ambivalenti, un punto in movimento senza alcun limite o confine di composizione. L'orizzonte inizia dove finisce la brillantezza del vetro.

MICHELE LOSITO

A continuous line with ambivalent directions, a moving point without any limit or boundary of composition. The horizon begins where the brilliance of the glass ends.

MICHELE LOSITO



Linea S6 project





Linea wall lamp

Linea S12





Linea S8 project

Linea colored version

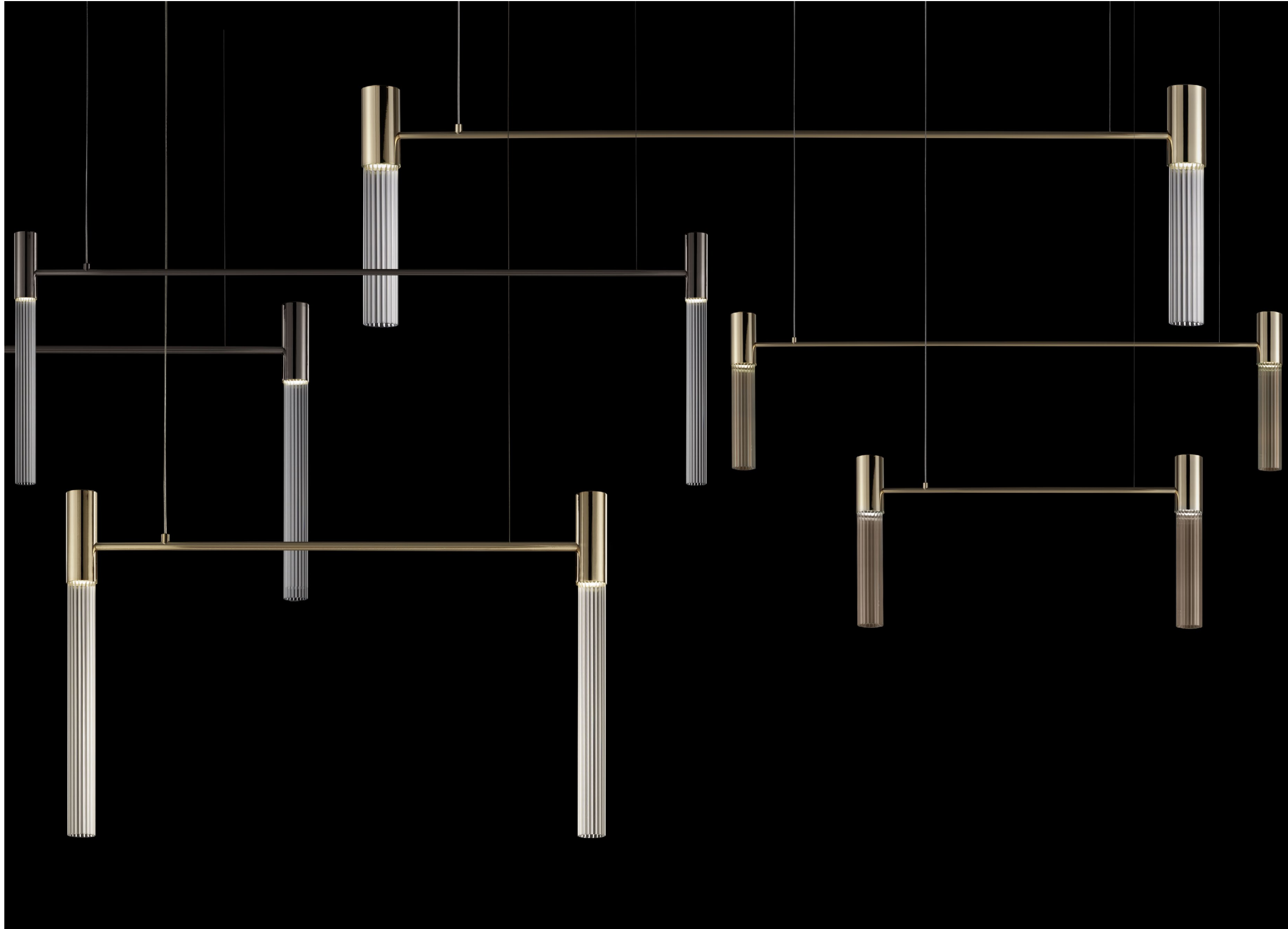

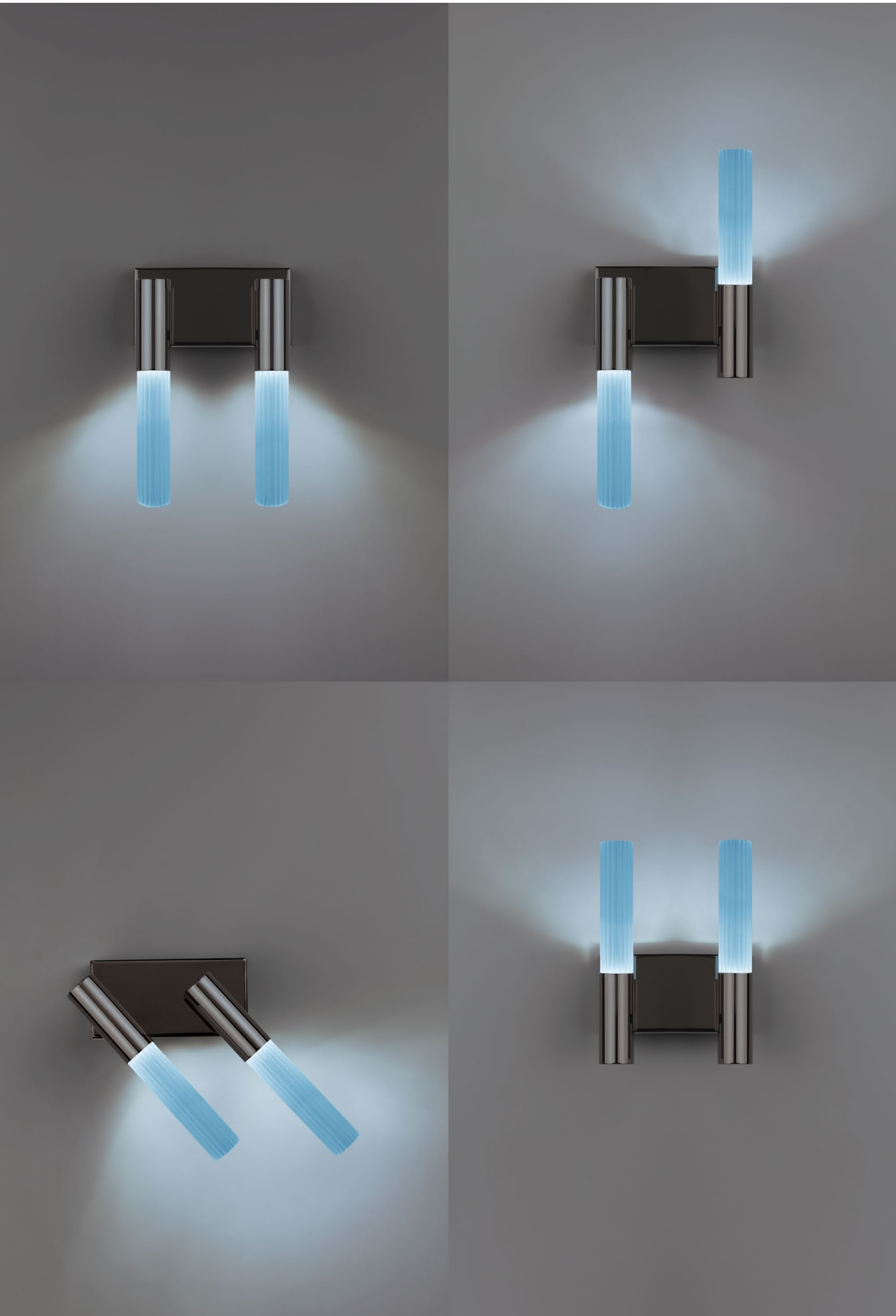

Linea wall lamp 2



Linea wall lamp special



114



Linea floor lamp

linea

TXXNTY BRAND DESIGN 24

115

linea

Michele Losito

Particolari - Details

Linea è un prodotto modulare che si può configurare in vari modi e in diverse forme.

Linea è già disponibile nelle misure indicate nei disegni. Struttura in ferro e boccole in alluminio realizzate su nostro disegno. Tubi in borosilicato in due differenti diametri: Ø 40 e Ø 60. Per qualsiasi richiesta o differente versione non esitate a contattarci.

Linea is a modular product that can be configured in various ways and in different shapes.

Linea is already available in the sizes shown in the drawings. Iron structure and aluminum bushings made on our drawing. Borosilicate tubes in two different diameters: Ø 40 and Ø 60. For any request or different version please contact us.

Metalli - Metals

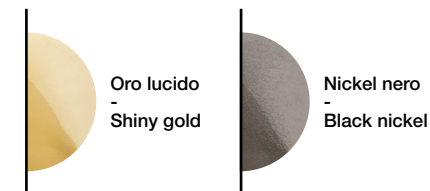

Vetro - Glass

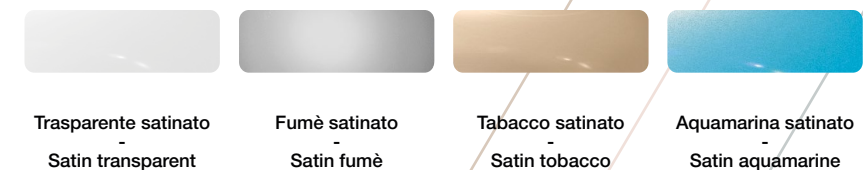

* Altre finiture e colori su richiesta - Other finishes and colors on request - see pag. 347-348 *

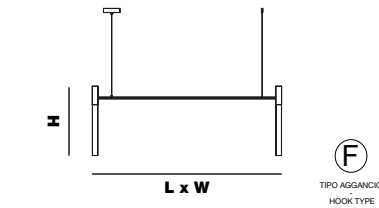

LINEA S2A tube 40

L x W 138 x 4,5 cm | 54,33" x 1,77"

H 51 cm | 19,88"

2 ledstar x 9W - 4000°K - 12 Vdc - SMD z5m2
880 lm - lifetime 30.000 h - Dimmable: yes

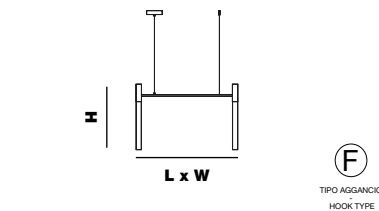

LINEA S2D tube 40

L x W 78,5 x 4,5 cm | 30,91" x 1,77"

H 51 cm | 19,88"

2 ledstar 9W - 4000°K - 12 Vdc - SMD z5m2
880 lm - lifetime 30.000 h - Dimmable: yes

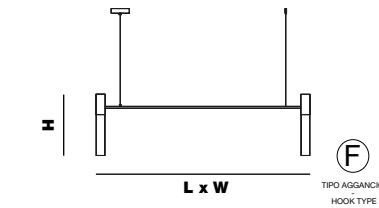

LINEA S2B tube 60

L x W 142 x 6,5 cm | 55,91" x 2,56"

H 41 cm | 15,94"

2 ledstar x 9W - 4000°K - 12 Vdc - SMD z5m2
880 lm - lifetime 30.000 h - Dimmable: yes

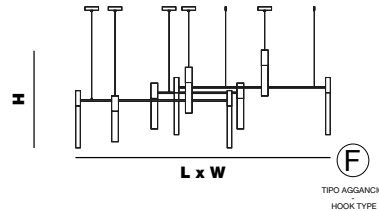

LINEA S12

L x W 225 x 125 cm | 88,58" x 49,21"

H 95 cm | 37,40"

12 ledstar 54W - 4000°K - 12 Vdc - SMD z5m2
5280 lm - lifetime 30.000 h - Dimmable: yes

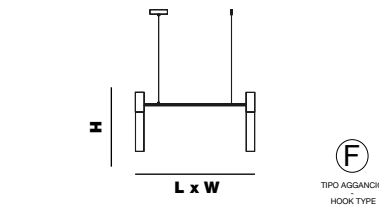

LINEA S2C tube 60

L x W 82 x 6,5 cm | 32,28" x 2,56"

H 41 cm | 15,94"

2 ledstar x 9W - 4000°K - 12 Vdc - SMD z5m2
880 lm - lifetime 30.000 h - Dimmable: yes

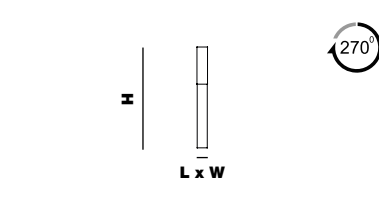

LINEA wall lamp

L x W 6 x 11 cm | 2,36" x 4,33"

H 36 cm | 14,17"

1 ledstar 4,5W - 4000°K - 12 Vdc - SMD z5m2
440 lm - lifetime 30.000 h - Dimmable: yes

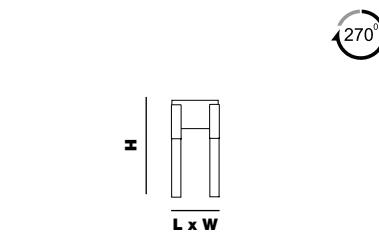

LINEA wall lamp 2

L x W 20,5 x 12 cm | 8,07" x 4,72"

H 45 cm | 17,72"

2 ledstar 9W - 4000°K - 12 Vdc - SMD z5m2
880 lm - lifetime 30.000 h - Dimmable: yes

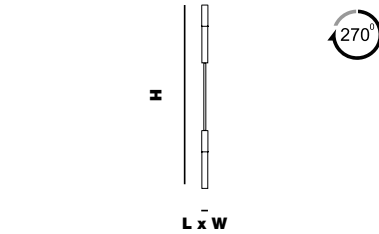

LINEA wall lamp special

L x W 4,5 x 10 cm | 39,04" x 1,77"

H 80 cm | 31,50"

2 ledstar 9W - 4000°K - 12 Vdc - SMD z5m2
880 lm - lifetime 30.000 h - Dimmable: yes

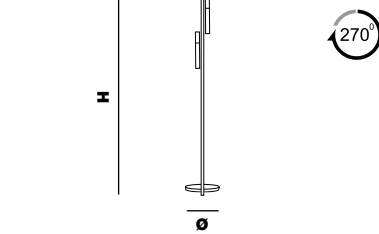

LINEA floor lamp

Ø 30 cm | 11,81"

H 150 cm | 59,05"

2 ledstar 9W - 4000°K - 12 Vdc - SMD z5m2
880 lm - lifetime 30.000 h - Dimmable: yes

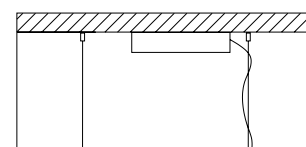

Altezza - Height
MIN 24 cm - 9.44"

F Aggancio con rosone, tiranti e tasselli a soffitto; altezza regolabile (F) - Hook with ceiling cup, metal cables and ceiling cable gripper; adjustable height (F)

270° Faretto regolabile fino a 270 gradi - Adjustable spotlight up to 270 degrees

* Specifiche agganci - Info on hooks pag. 345 *

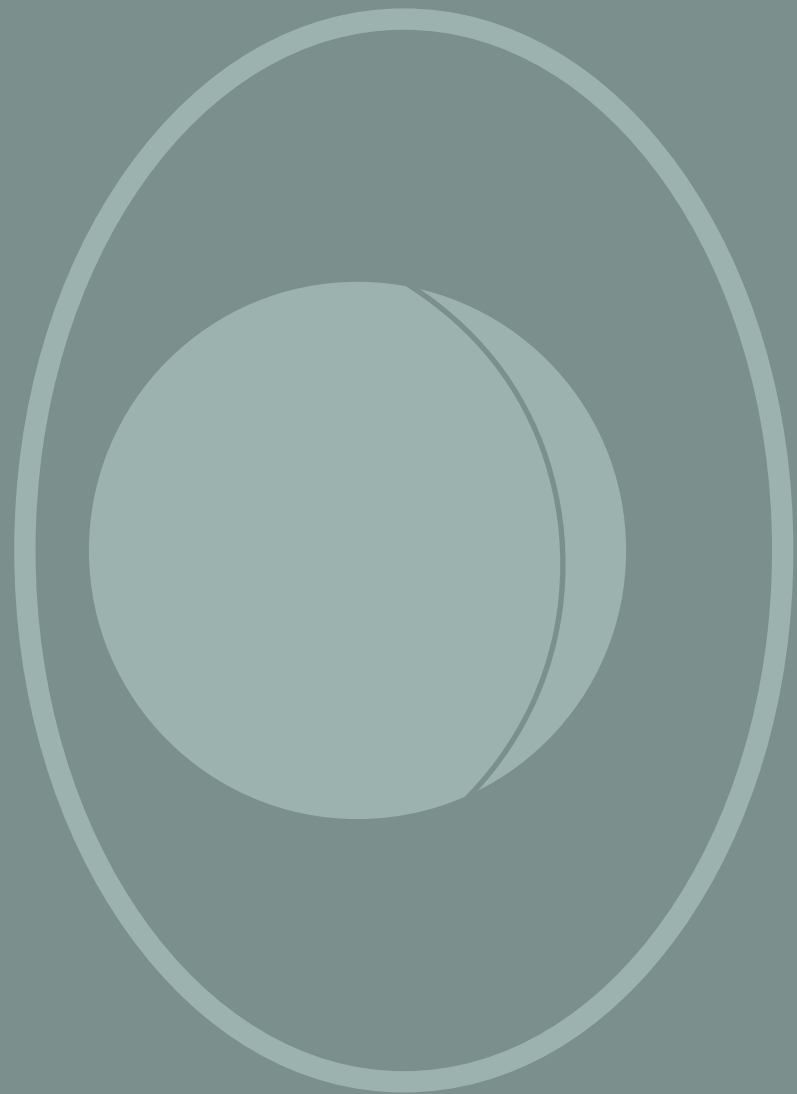

illusione

È una lampada da parete eterea dalla natura misteriosa e sfuggente, un portale magico che porta in un altro mondo, proprio come quando Alice ha attraversato lo specchio.

ALBERTO GHIRARDELLO



It is an ethereal wall lamp with a mysterious and elusive nature, a magical portal that leads to another world, just like when Alice crossed the mirror.

ALBERTO GHIRARDELLO



Illusione wall lamp small





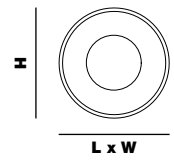

ILLUSIONE wall lamp big

L x W 45 cm x 13 cm | 17,72" x 5,12"
H 45 cm | 17,72"

1 GX53 bulb 6W - 3000°K - 220 Vdc
560 lm - life time 15.000 hrs - Dimmable: no

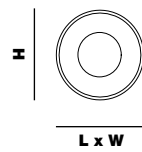

ILLUSIONE wall lamp small

L x W 35 cm x 10 cm | 13,78" x 3,94"
H 35 cm | 13,78"

1 GX53 bulb 6W - 3000°K - 220 Vdc
560 lm - life time 15.000 hrs - Dimmable: no

illusione

Alberto Ghirardello

Particolari - Details

Struttura in metallo realizzata su disegno.

Mezza sfera in vetro soffiato con effetto bolle sabbiate internamente, made in Veneto. La base dell'applicque è in cromo specchiato, per creare illusione ottica: la mezza sfera in vetro riflettendosi crea immagine di sfera intera.

Per qualsiasi richiesta o differente versione non esitate a contattarci

Metal structure made on drawing.

Half blown glass sphere with bubble effect internally sandblasted, made in Veneto. The base of the wall lamp is in mirrored chrome, in order to create an optical illusion: the glass half sphere reflects itself and creates the image of a whole sphere.

Do not hesitate to contact us for any request or different version

Metalli - Metals

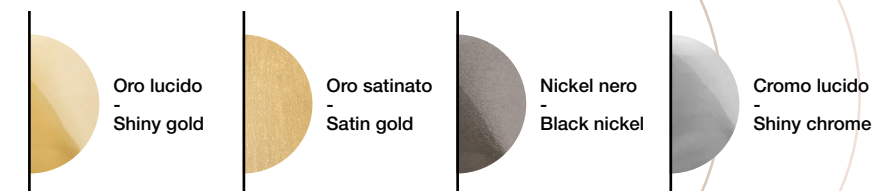

Vetro - Glass



* Altre finiture e colori su richiesta - Other finishes and colors on request - see pag. 347-348 *



parachute

Un'icona di design contemporaneo che cattura la poesia e la funzionalità del paracadute, trasformandolo in un oggetto d'arte illuminato che arreda gli spazi con stile e raffinatezza.

DANIEL BECKER

An icon of contemporary design that captures the poetry and functionality of the parachute, transforming it into an illuminated work of art that decorates spaces with style and sophistication.

DANIEL BECKER



Parachute L8





Parachute L8



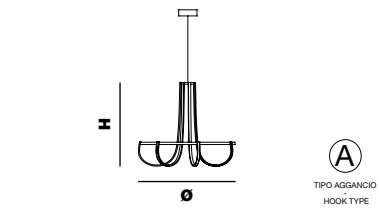

PARACHUTE L8

Ø 90 cm | 35,43"
H 73 cm | 28,74"

8 striped 138W - 4000°K - 24 Vdc - SMD 2835
12.960 lm - life time 50.000 hrs - Dimmable: yes

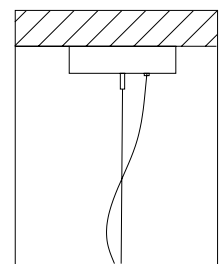

Altezza - Height
MIN 18 cm - 7.08"

Aggancio con rosone o scatola in metallo
e tirante in metallo; altezza regolabile (A)
- Hook with ceiling cup or metal box and
metal cable; adjustable height (A)

* Specifiche agganci - Info on hooks pag. 345 *

parachute

Daniel Becker

Particolari - Details

Componenti in alluminio torniti, fresati e curvati su disegno. Per qualsiasi richiesta o differente versione non esitate a contattarci.

-

Aluminum components turned, milled and bent on drawing. Do not hesitate to contact us for any request or different version.

Metalli - Metals



Silicone

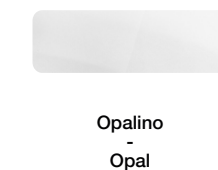

* Altre finiture e colori su richiesta - Other finishes and colors on request - see pag. 347-348 *



itala

Illuminare non è solo una necessità, ma un'arte. Queste sospensioni luminose sono progettate per adattarsi a una vasta gamma di spazi e design d'interni. Con l'abilità di combinare più elementi, potrete creare atmosfere straordinarie per spazi grandi o piccoli.

MICHELE LOSITO

Illuminating is not just a necessity, but an art. These pendant lights are designed to adapt to a wide range of spaces and interior designs. With the ability to combine multiple elements, you can create extraordinary atmospheres for both large and small spaces.

MICHELE LOSITO

Itala S9



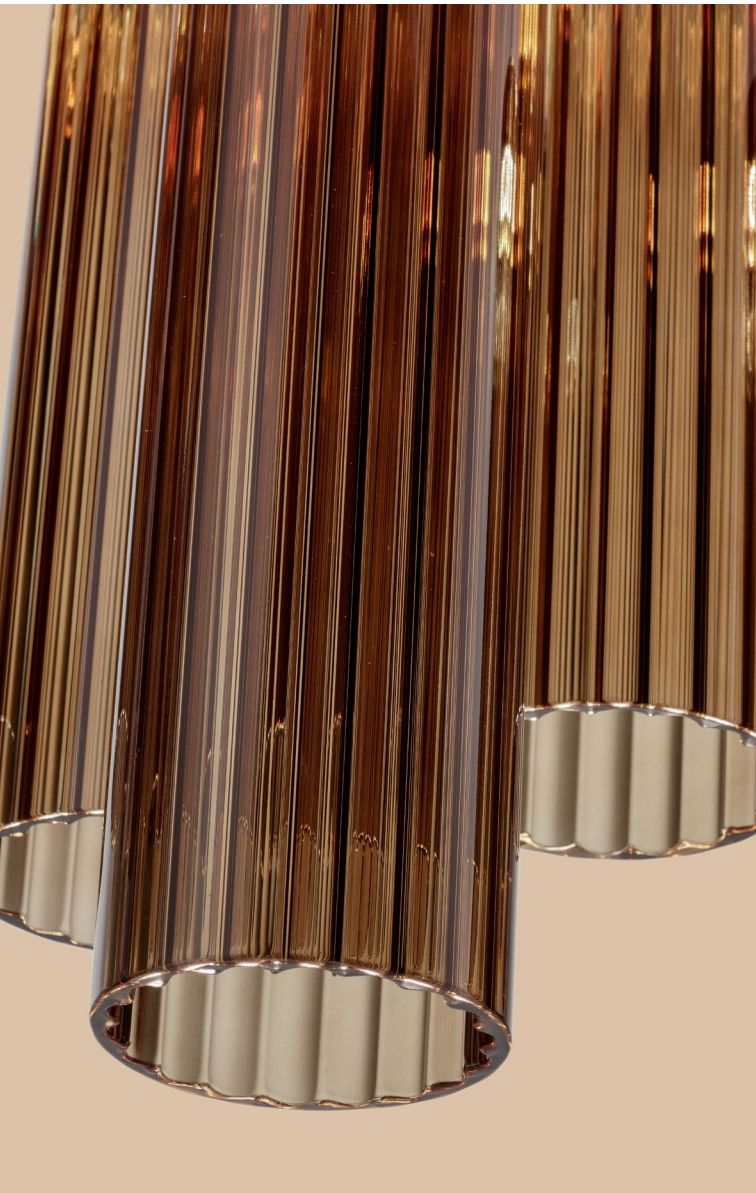

Itala S3





Itala S1

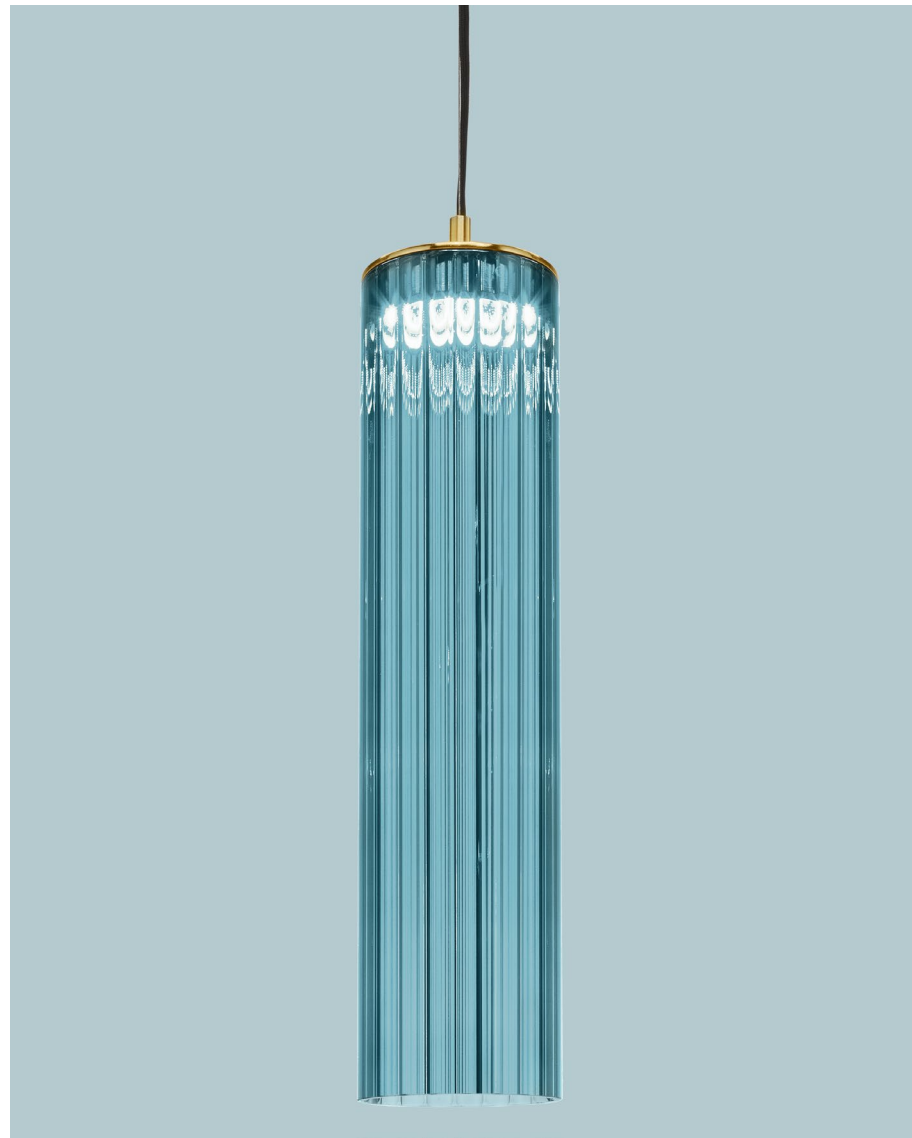



Itala lamp medium | big | small

Itala medium lamp fumè



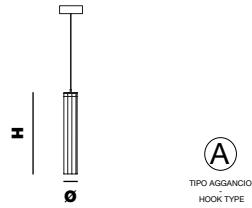

ITALA S1 big

Ø 12 cm | 4,72"
H 70 cm | 27,56"

1 Spotted 10W - 3000°K - 220 Vdc - SMD MA3
1000 lm - life time 50.000 hrs - Dimmable: yes

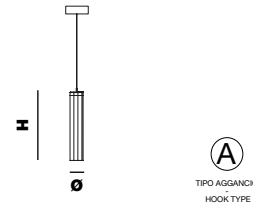

ITALA S1 medium

Ø 12 cm | 4,72"
H 60 cm | 23,62"

1 Spotted 10W - 3000°K - 220 Vdc - SMD MA3
1000 lm - life time 50.000 hrs - Dimmable: yes

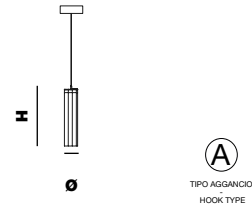

ITALA S1 small

Ø 12 cm | 4,72"
H 50 cm | 19,69"

1 Spotted 10W - 3000°K - 220 Vdc - SMD MA3
1000 lm - life time 50.000 hrs - Dimmable: yes

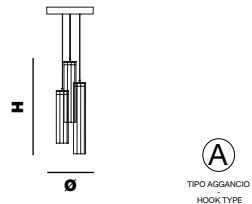

ITALA S3

Ø 30 cm | 11,81"
H 100 cm | 39,37"

3 Spotted 30W - 3000°K - 220 Vdc - SMD MA3
3000 lm - life time 50.000 hrs - Dimmable: yes

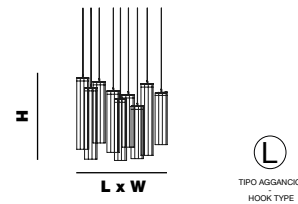

ITALA S9

L x W 78 x 30 cm | 30,71" x 11,81"
H 98 cm | 38,58"

9 Spotted 90W - 3000°K - 220 Vdc - SMD MA3
9000 lm - life time 50.000 hrs - Dimmable: yes

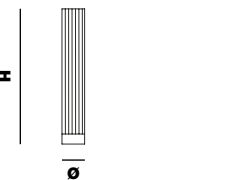

ITALA big lamp

Ø 12 cm | 4,72"
H 70 cm | 27,56"

1 GX53 6W - 3000°K - 220 Vdc - 560 lm
life time 50.000 hrs - Dimmable: no

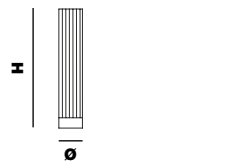

ITALA medium lamp

Ø 12 cm | 4,72"
H 60 cm | 23,62"

1 GX53 6W - 3000°K - 220 Vdc - 560 lm
life time 50.000 hrs - Dimmable: no

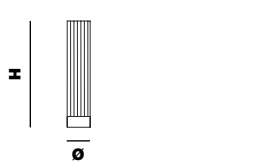

ITALA small lamp

Ø 12 cm | 4,72"
H 50 cm | 19,69"

1 GX53 6W - 3000°K - 220 Vdc - 560 lm
life time 50.000 hrs - Dimmable: no

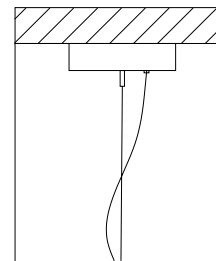

Altezza - Height
MIN 18 cm - 7.08"

Aggancio con rosone o scatola in metallo e tirante in metallo; altezza regolabile (A)
- Hook with ceiling cup or metal box and metal cable; adjustable height (A)



Aggancio da definire (L)
Hooks to be defined (L)

itala

Michele Losito

Particolari - Details

Boccola realizzata in alluminio su nostro disegno. Tubi in borosilicato e successivamente decorati. Itala è già disponibile nelle misure indicate nei disegni. È possibile richiedere un progetto esclusivo che si adatti al meglio ai vostri spazi e soddisfi le vostre esigenze. Per qualsiasi richiesta o differente versione non esitate a contattarci.

Bushings made from aluminum based on our design. Borosilicate glass tubes and then decorated. Itala is already available in the dimensions specified in the drawings. It is possible to request an exclusive project that best suits your spaces and meets your needs. For any inquiries or different versions, please do not hesitate to contact us.

Metalli - Metals



Vetro - Glass



Guarda il video

Watch video

* Specifiche agganci - Info on hooks pag. 345 *

* Altre finiture e colori su richiesta - Other finishes and colors on request - see pag. 347-348 *



atlas

Atlas è una versatile collezione dalle dimensioni contenute e dall'aspetto fine e garbato, discreto ma al contempo dotato di un carattere incisivo e riconoscibile.

ALBERTO GHIRARDELLO

Atlas is a versatile collection with small dimensions and a fine and graceful appearance, discreet but at the same time with an incisive and recognizable character.

ALBERTO GHIRARDELLO



Atlas lamp





Atlas lamp





Atlas lamp





Atlas S6



Atlas S4



Atlas lamp



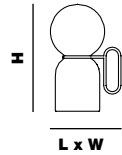

ATLAS lamp

L x W 16 x 12 cm | 6,30" x 4,72"
H 24 cm | 9,45"

1 G9 bulb x max 7W - 220 Vdc

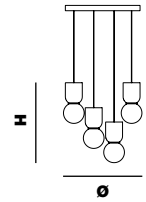

ATLAS S4

Ø 60 cm | 23,62"
H 60 cm | 23,62"

4 G9 bulb x max 7W - 220 Vdc
dimmmable: yes

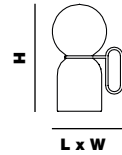

ATLAS battery lamp

L x W 16 x 12 cm | 6,30" x 4,72"
H 24 cm | 9,45"

1 cabled 2 W - 4000°K - 3,7 Vdc - 440 Lm
dimmmable: yes

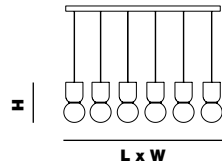

ATLAS S6

L x W 100 x 15 cm | 39,37" x 5,91"
H 27 cm | 10,63"

6 G9 bulb x max 7W - 220 Vdc
dimmmable: yes

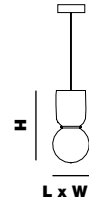

ATLAS S1

Ø 12 cm | 4,72"
H 24 cm | 9,45"

1 G9 bulb x max 7W - 220 Vdc
dimmmable: yes



TIPO AGGANCIO
HOOK TYPE



TIPO AGGANCIO
HOOK TYPE



TIPO AGGANCIO
HOOK TYPE

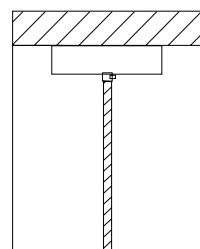

Altezza - Height
MIN 18 cm - 7.08"



Aggancio con rosone o scatola a soffitto e cavo di alimentazione; altezza regolabile (D) - Hook with ceiling cup and power cord; adjustable height (D)

atlas

Alberto Ghirardello

Particolari - Details

Componenti in metallo, alluminio e ottone. Sfere in borosilicato con texture rigato verticale e rigato ritorto. Possibilità di richiedere Atlas lamp con cavo e lampadina G9 - 220 Vdc o Atlas battery lamp con led e sistema batteria ricaricabile, LI- Po (litio e polimeri di litio) 8000 mAh. Accensione e dimmerazione con pulsante touch. Durata nominale 8 H. Per qualsiasi richiesta o differente versione non esitate a contattarci.

Metal, aluminum and brass components. Borosilicate spheres with vertical striped texture and twisted striped. Possibility to request Atlas lamp with cable and bulb G9 - 220 Vdc and Atlas battery lamp with led and rechargeable battery system LI- Po (lithium and lithium polymers) 8000 mAh. Nominal duration 8 H. Ignition and dimming with touch button. Do not hesitate to contact us for any request or different version.

Metalli - Metals

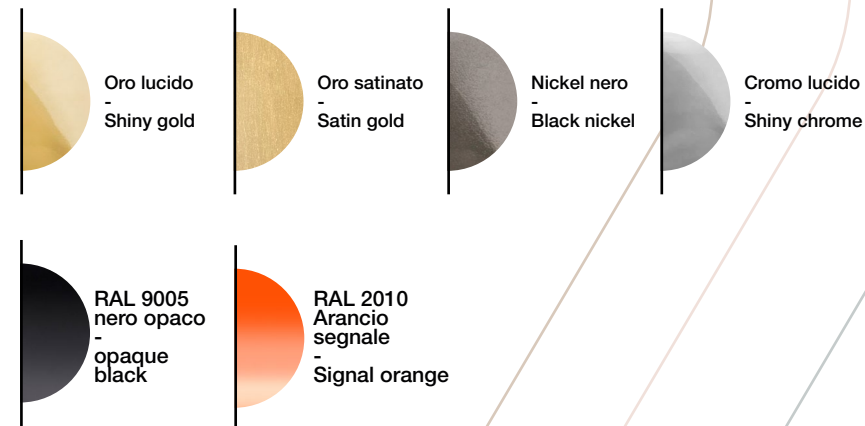

Vetro - Glass

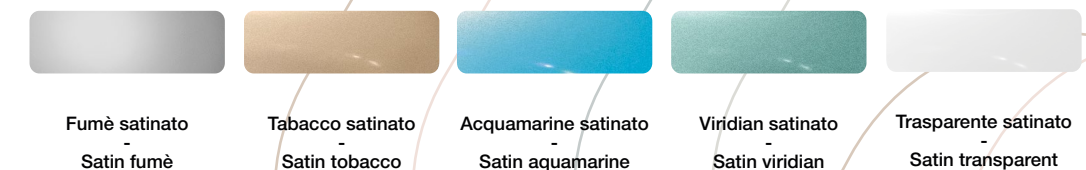

* Specifiche agganci - Info on hooks pag. 345 *

* Altre finiture e colori su richiesta - Other finishes and colors on request - see pag. 347-348 *



corallo

*Nella forma ricorda le isole coralline.
La lucentezza delle molature realizzate a mano
richiama lo scintillio delle acque scaldate dalla luce del sole.*

STUDIO IN PROJECT

*The shape is reminiscent of coral islands.
The sheen of hand grinding recalls the sparkle
of the water warmed by sunlight.*

STUDIO IN PROJECT

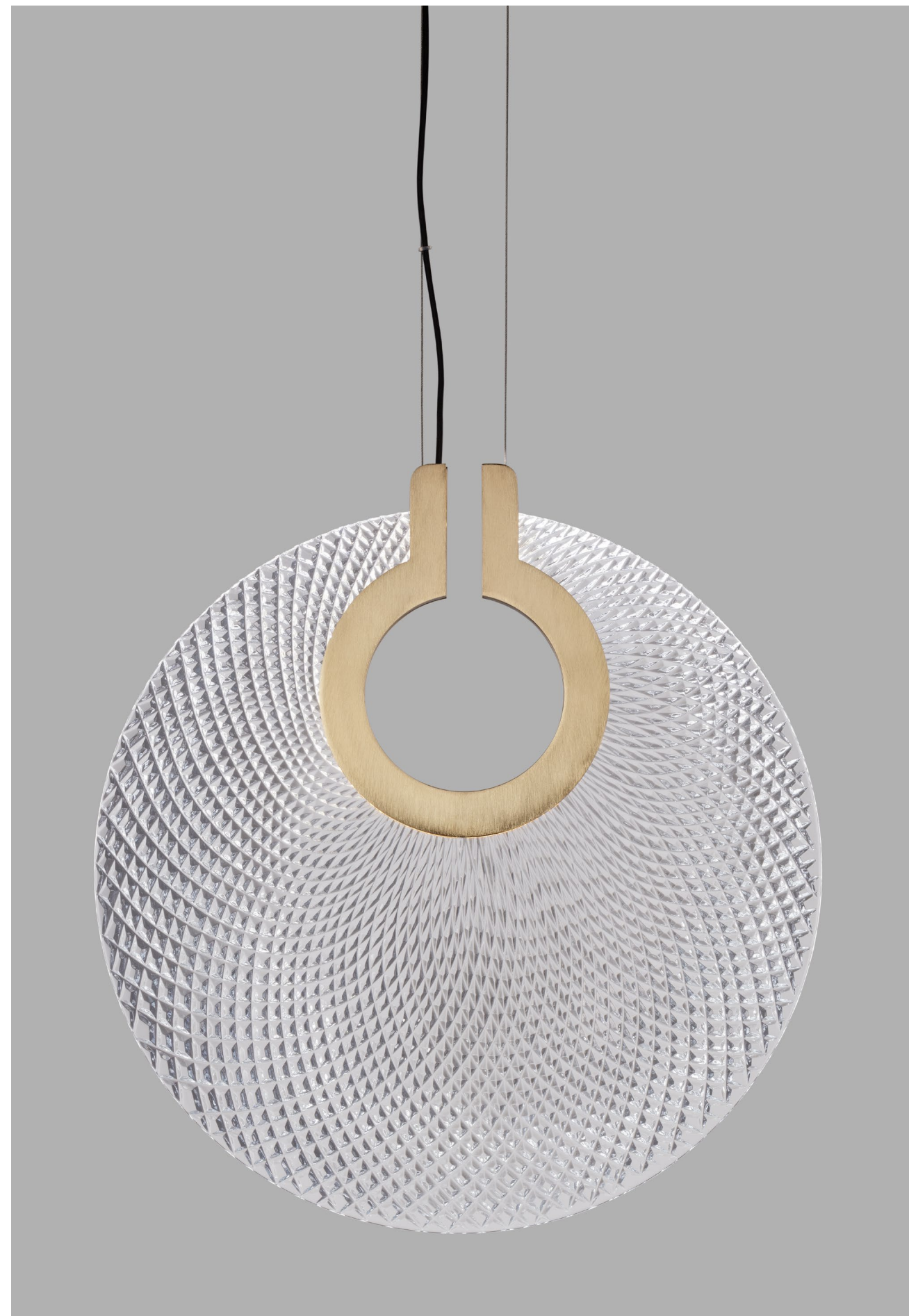



Corallo wall lamp

Corallo lamp big | small

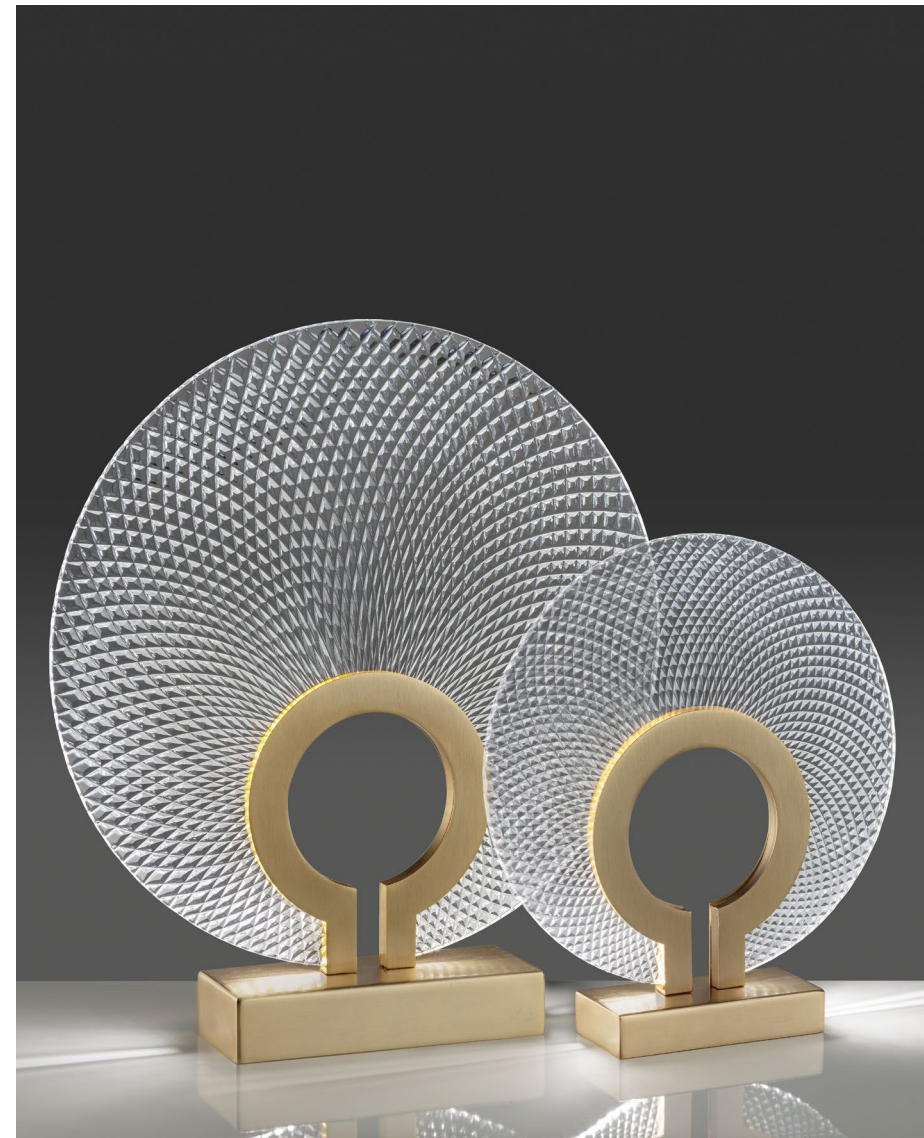



Corallo S3





Corallo S6

Corallo 50

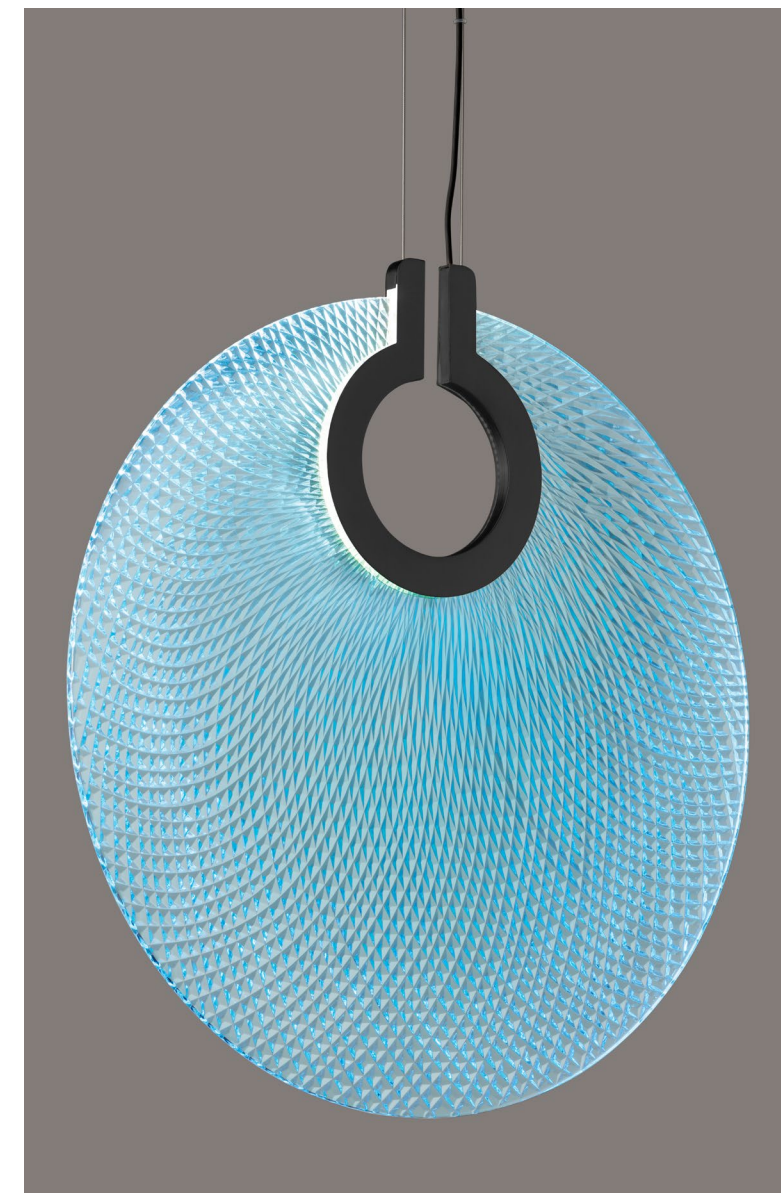



Corallo 40





Corallo floor lamp

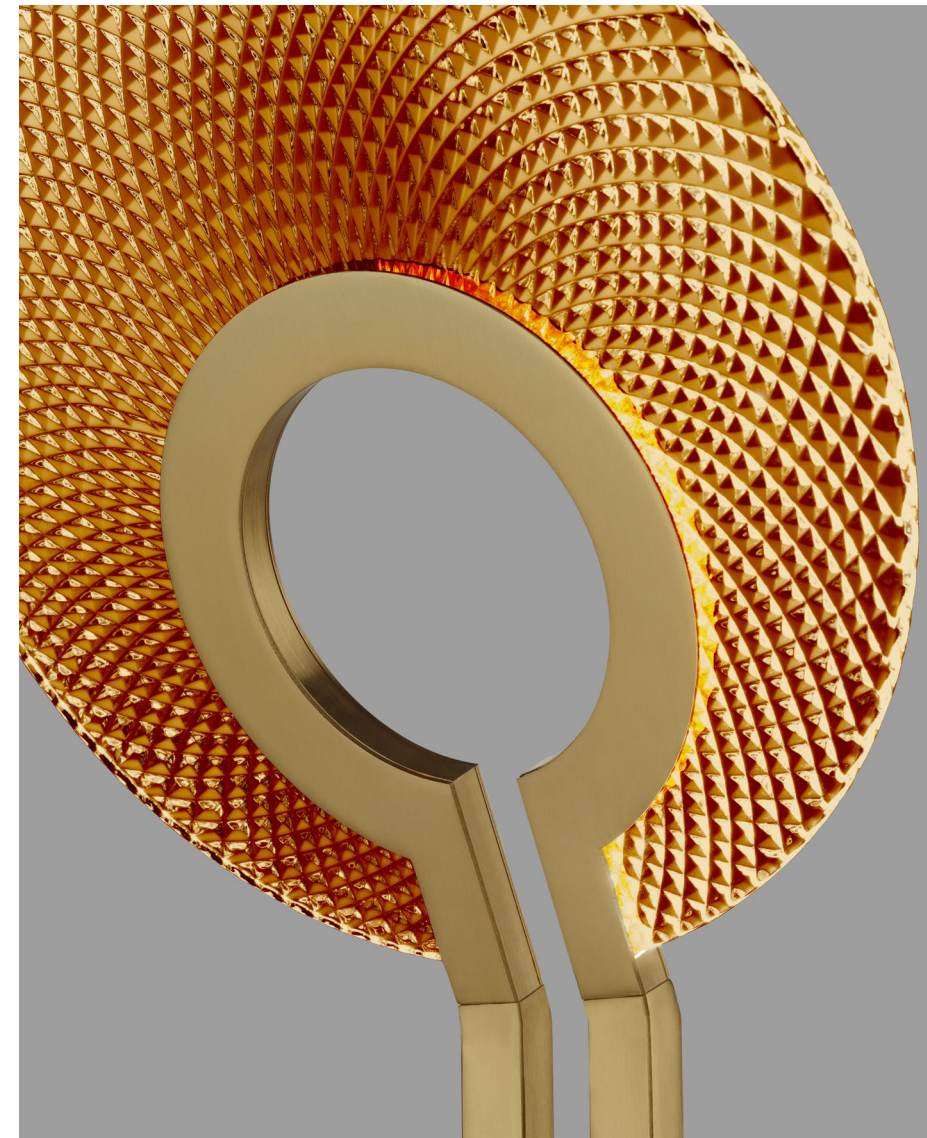

Corallo 30

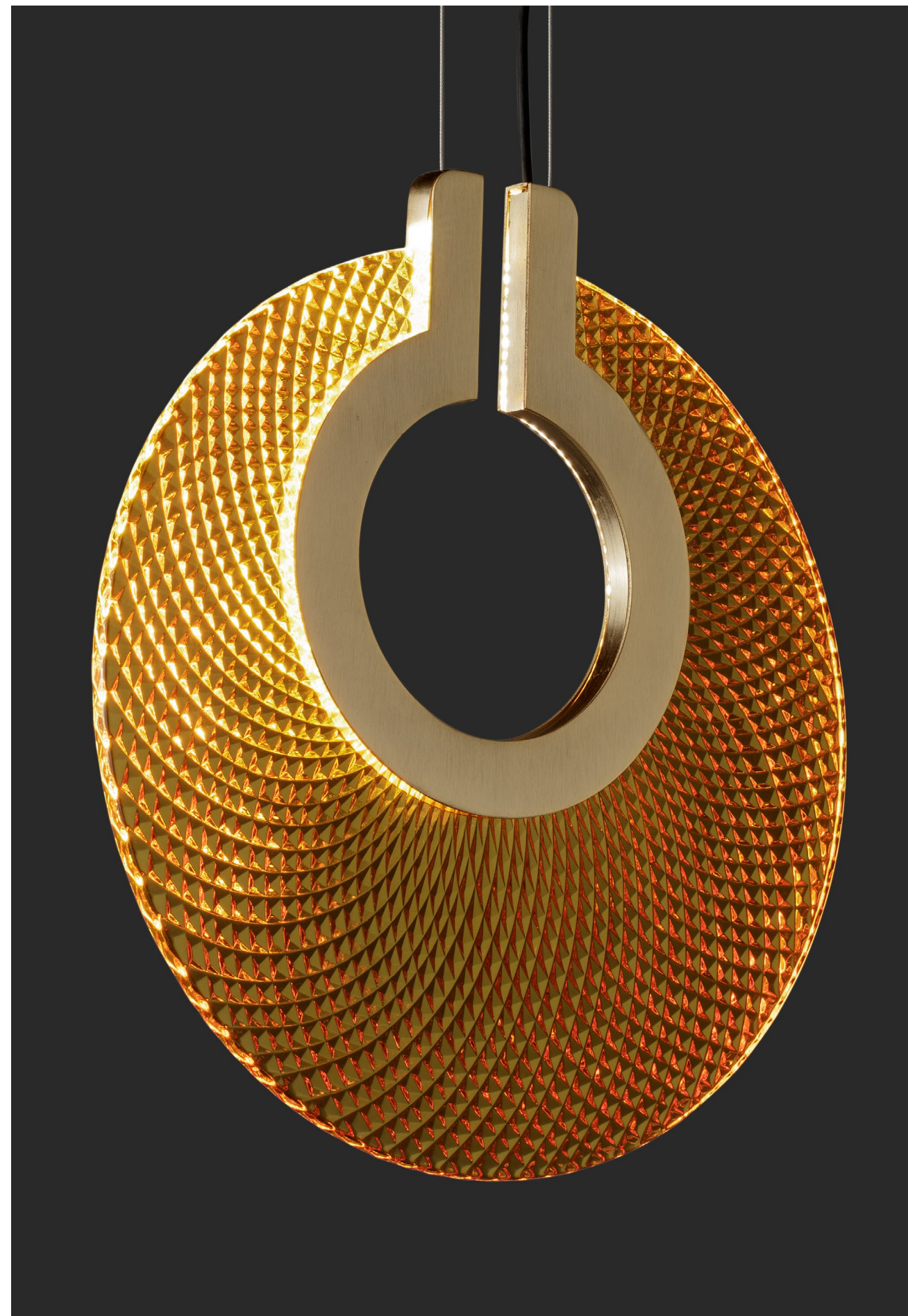

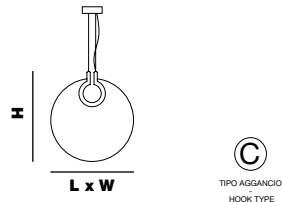

CORALLO 50

L x W 50 x 2 cm | 19,69" x 0,79"
H 56 cm | 22,05"

striped 7,1W - 3000°K - 24 Vdc - SMD 2835
660 lm - life time 50.000 hrs - Dimmable: yes

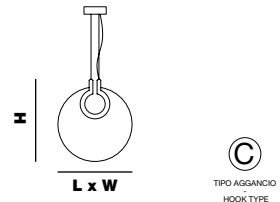

CORALLO 40

L x W 40 x 2 cm | 15,75" x 0,79"
H 46 cm | 18,11"

striped 7,1W - 3000°K - 24 Vdc - SMD 2835
660 lm - life time 50.000 hrs - Dimmable: yes

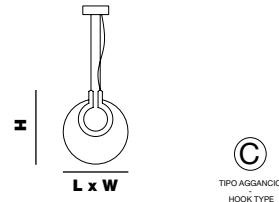

CORALLO 30

L x W 30 x 2 cm | 11,81" x 0,79"
H 36 cm | 14,17"

striped 7,1W - 3000°K - 24 Vdc - SMD 2835
660 lm - life time 50.000 hrs - Dimmable: yes

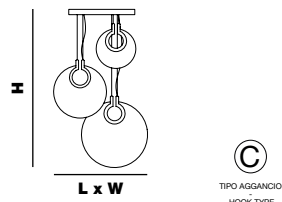

CORALLO S3

L x W 80 x 20 cm | 31,50" x 7,87"
H 100 cm | 39,37"

striped 21,3W - 3000°K - 24 Vdc - SMD 2835
1980 lm - life time 50.000 hrs - Dimmable: yes

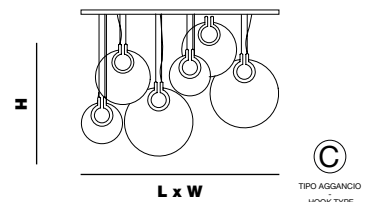

CORALLO S6

L x W 120 x 25 cm | 47,24" x 9,84"
H 95 cm | 37,40"

striped 42,6W - 3000°K - 24 Vdc - SMD 2835
30960 lm - life time 50.000 hrs - Dimmable: yes

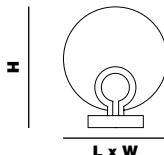

CORALLO big lamp

L x W 40 x 8 cm | 15,75" x 3,15"
H 45 cm | 17,52"

strip-led 7,1W - 3000°K - 24 Vdc - SMD 2835
660 lm - life time 50.000 hrs - Dimmable: yes

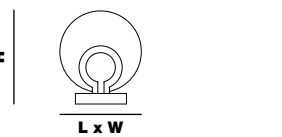

CORALLO small lamp

L x W 30 x 7 cm | 11,81" x 2,76"
H 34 cm | 13,19"

striped 7,1W - 3000°K - 24 Vdc - SMD 2835
660 lm - life time 50.000 hrs - Dimmable: yes

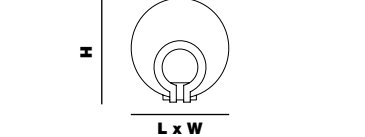

CORALLO wall lamp

L x W 30 x 16 cm | 11,81" x 6,30"
H 30 cm | 11,81"

striped 7,1W - 3000°K - 24 Vdc - SMD 2835
660 lm - life time 50.000 hrs - Dimmable: yes

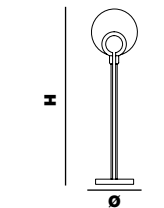

CORALLO floor lamp

Ø 30 cm | 11,81"
H 150 cm | 59,05"

strip-led 7,1W - 3000°K - 24 Vdc - SMD 2835
660 lm - life time 50.000 hrs - Dimmable: yes

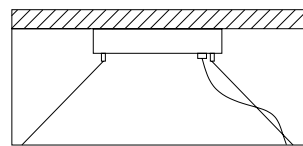

Altezza - Height
MIN 24 cm - 9,44"

C Aggancio con rosone o scatola e tiranti per sospensioni. Altezza regolabile (C)
Hook with ceiling cup or metal box and metal cables for suspension. Adjustable height (C)

corallo

Studio in Project

Particolari - Details

Strutture realizzate artigianalmente. Dischi in vetro con effetto diamantato molati a mano. Per qualsiasi richiesta o differente versione non esitate a contattarci.

Handcrafted structures. Glass disks with hand ground diamond effect. For any request or different version please contact us.

Metalli - Metals

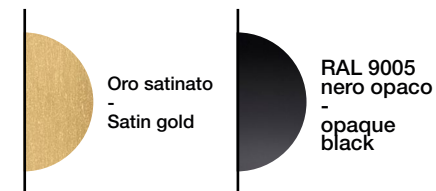

Vetro - Glass

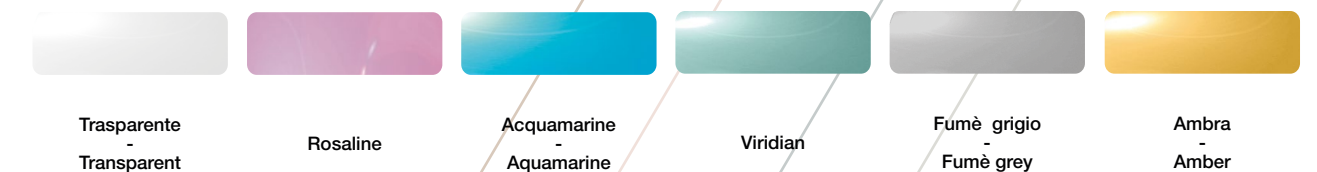

Guarda il video

Watch video

* Specifiche agganci - Info on hooks pag. 345 *

* Altre finiture e colori su richiesta - Other finishes and colors on request - see pag. 347-348 *

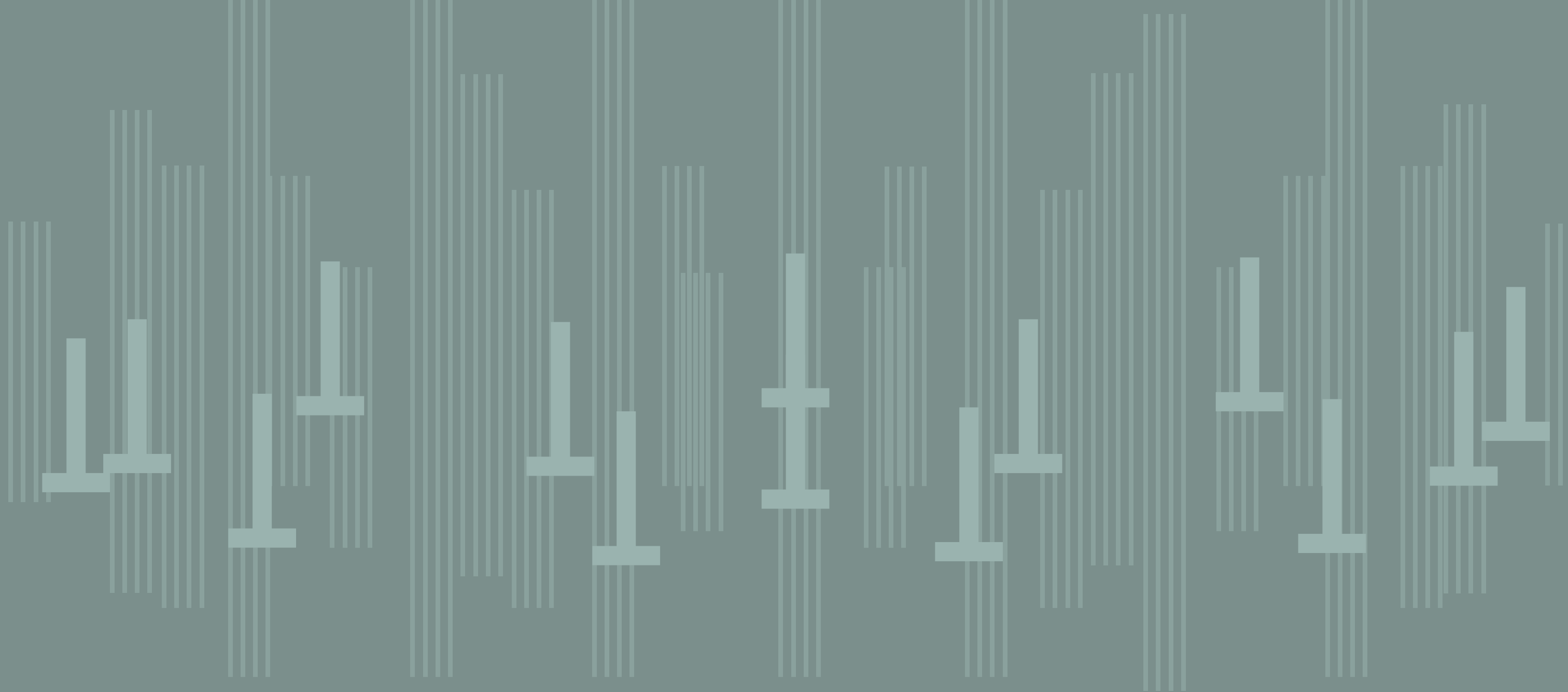

abstract

Astract nasce con la fusione di due elementi, con uno straordinario aspetto enigmatico: l'alluminio solido e materico si contrappone alla delicatezza del vetro borosilicato per creare scenografie altamente decorative e personalizzabili.

STUDIO IN PROJECT

Astract was born from the fusion of two elements, with a special enigmatic aspect: solid and textured aluminum contrasts with the delicacy of borosilicate glass to create highly decorative and customizable settings.

STUDIO IN PROJECT





Astract oval





Astract ellipse





Astract diamante





Astract wave



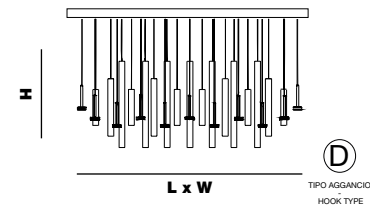

ASTRACT ellipse

L x W 150 x 55 cm | 59,06" x 21,65"
H 60 cm | 23,62"

45 led 173 W - 12 Vdc 4000 °K - 16600 lm
 life time 30.000 hrs - Dimmable: yes

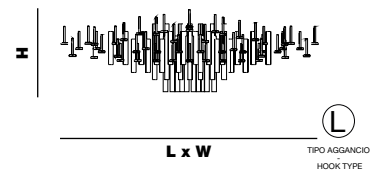

ASTRACT oval

L x W 250 x 180 cm | 98,43" x 70,87"
H 120 cm | 47,24"

158 led 664W - 12 Vdc - 4000 °K - 53840 lm
 life time 30.000 hrs - Dimmable: yes

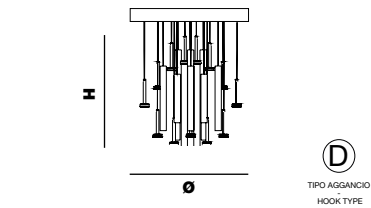

ASTRACT diamante

Ø 65 cm | 25,59"
H 70 cm | 27,56"

41 led 152W 12 Vdc - 4000 °K - 14520 lm
 life time 30.000 hrs - Dimmable: yes

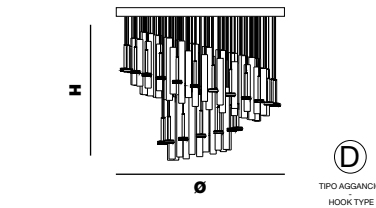

ASTRACT wave

Ø 100 cm | 39,37"
H 80 cm | 31,50"

41 led 152W - 12 Vdc - 4000 °K - 39520 lm
 life time 30.000 hrs - Dimmable: yes

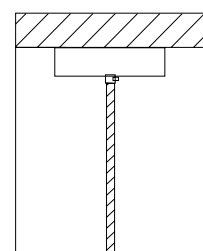

Altezza - Height
 MIN 18 cm - 7.08"



Aggancio con rosone o scatola a soffitto e cavo di alimentazione; altezza regolabile (D) - Hook with ceiling cup and power cord; adjustable height (D)



Aggancio da definire (L)
 Hooks to be defined (L)

astract

Studio in Project

Particolari - Details

Faretto e boccia realizzati in alluminio su nostro disegno. Tubi in borosilicato e successivamente decorati. Astract è già disponibile nelle misure indicate nei disegni. È possibile richiedere un progetto esclusivo che si adatti al meglio ai vostri spazi e soddisfi le vostre esigenze. Per qualsiasi richiesta o differente versione non esitate a contattarci.

Spotlights and bushings made from aluminum based on our design. Borosilicate glass tubes and then decorated. Astract is already available in the dimensions specified in the drawings. It is possible to request an exclusive project that best suits your spaces and meets your needs. For any inquiries or different versions, please do not hesitate to contact us.

Metalli - Metals

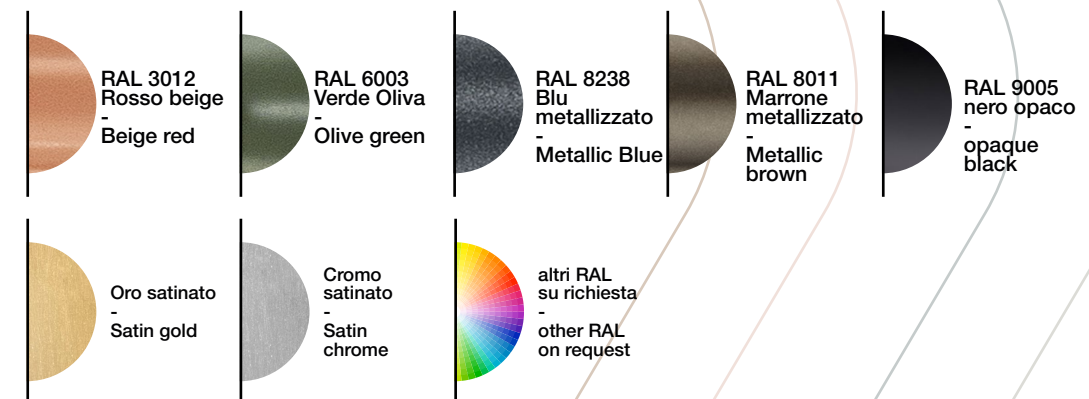

Vetro - Glass



Plexiglass



* Specifiche agganci - Info on hooks pag. 345 *

* Altre finiture e colori su richiesta - Other finishes and colors on request - see pag. 347-348 *

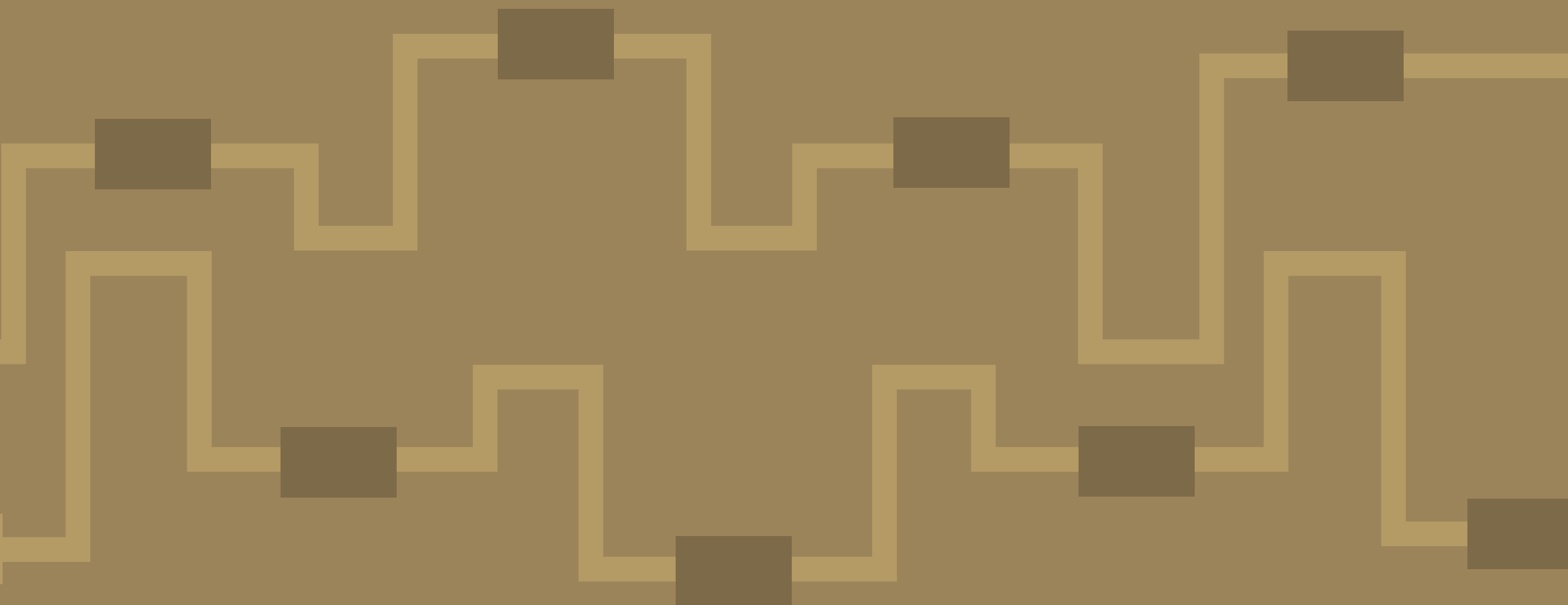

essential

*Un incrocio di luci e linee.
Lo stretto necessario, l'essenziale.*

STUDIO IN PROJECT

*An intersection of lights and lines.
The strictly necessary, the essential.*

STUDIO IN PROJECT





Essential L24

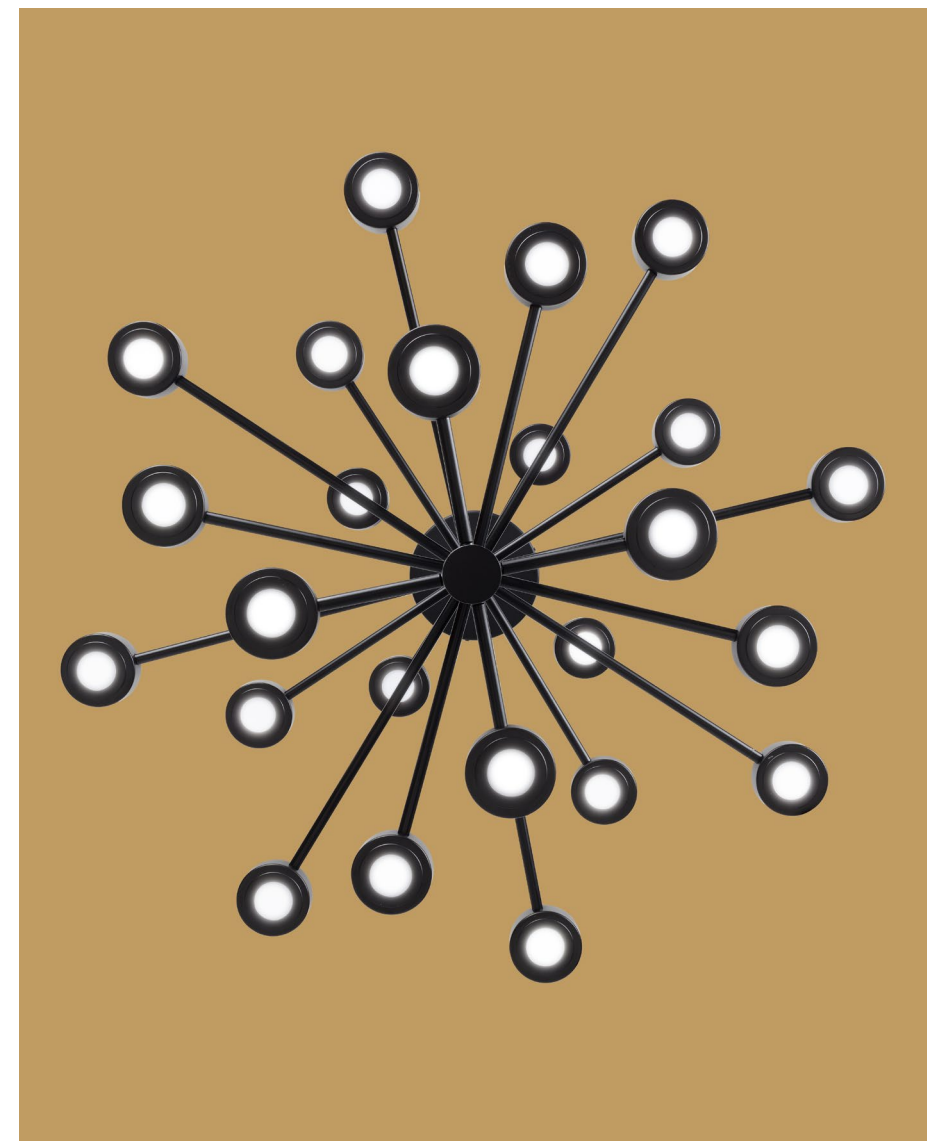

Essential linear



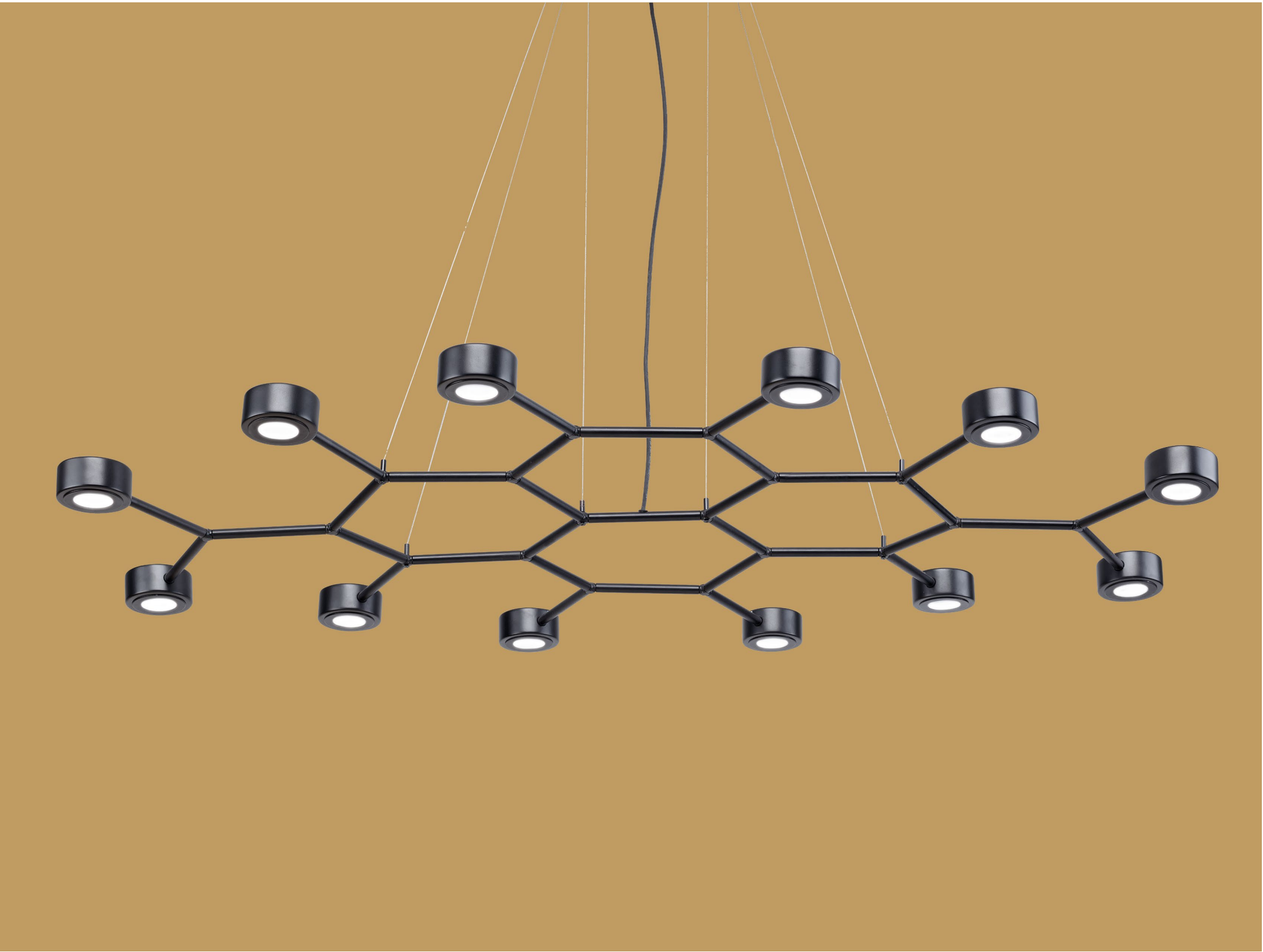

Essential grid



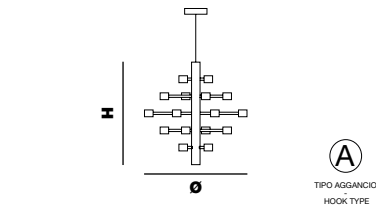

ESSENTIAL L24

Ø 90 cm | 35,43"
H 90 cm | 35,43"

24 spot led 72W - 4000°K - 12 Vdc - 6720 lm
life time 30.000 hrs - SMD type 5630 - Dimmable: yes

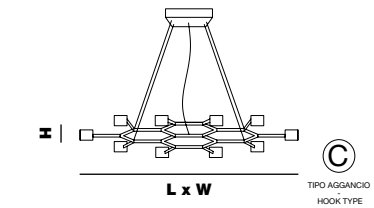

ESSENTIAL grid

L x W 128 x 90 cm | 50,39" x 35,43"
H 6 cm | 2,36"

12 spot led 36W - 4000°K - 12 Vdc - 3360 lm
life time 30.000 hrs - SMD type 5630 - Dimmable: yes

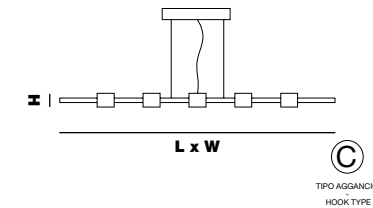

ESSENTIAL linear

L x W 122 x 8 cm | 48,03" x 3,15"
H 6 cm | 2,36"

5 spot led 15W - 4000°K - 12 Vdc - 1400 lm
life time 30.000 hrs - SMD type 5630 - Dimmable: yes

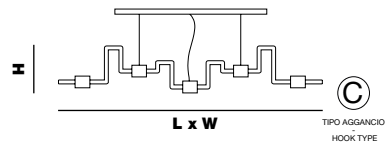

ESSENTIAL creativity

L x W 135 x 8 cm | 53,15" x 3,15"
H 22 cm | 8,66"

5 spot led 15W - 4000°K - 12 Vdc - 1400 lm
life time 30.000 hrs - SMD type 5630 - Dimmable: yes

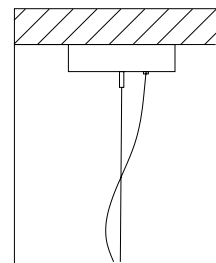

A

Altezza - Height
MIN 18 cm - 7.08"

Aggancio con rosone o scatola in metallo e tirante in metallo; altezza regolabile (A)
- Hook with ceiling cup or metal box and metal cable; adjustable height (A)

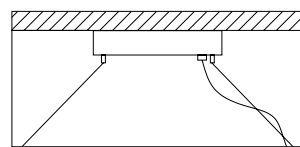

C

Altezza - Height
MIN 24 cm - 9.44"

Aggancio con rosone o scatola e tiranti per sospensioni. Altezza regolabile (C)
Hook with ceiling cup or metal box and metal cables for suspension. Adjustable height (C)

essential

Studio in Project

Particolari - Details

Sospensioni realizzate artigianalmente su disegno. Boccole portate in ferro tornite. Boccole raccordo in ottone. È possibile richiedere differenti misure, numero di led e configurazioni. Non esitate a contattarci per un progetto esclusivo che si adatti al meglio ai vostri spazi e soddisfi le vostre esigenze.

The suspensions are realized handmade on our drawing Turned iron led holder bushings. Brass connecting bushings. It is possible to request different sizes, number of LEDs and configurations. Do not hesitate to contact us for an exclusive project that best suits your spaces and meets your needs.

Metalli - Metals



Plexiglass



Opalino
-
Opal



Guarda il video

-

Watch video

* Specifiche agganci - Info on hooks pag. 345 *

* Altre finiture e colori su richiesta - Other finishes and colors on request - see pag. 347-348 *



astral

*Astral è lo spettacolo del cosmo rutilante
con le sue costellazioni: le stelle, come fori nel cielo, lasciano
filtrare la luce dell'infinito.*

STUDIO IN PROJECT

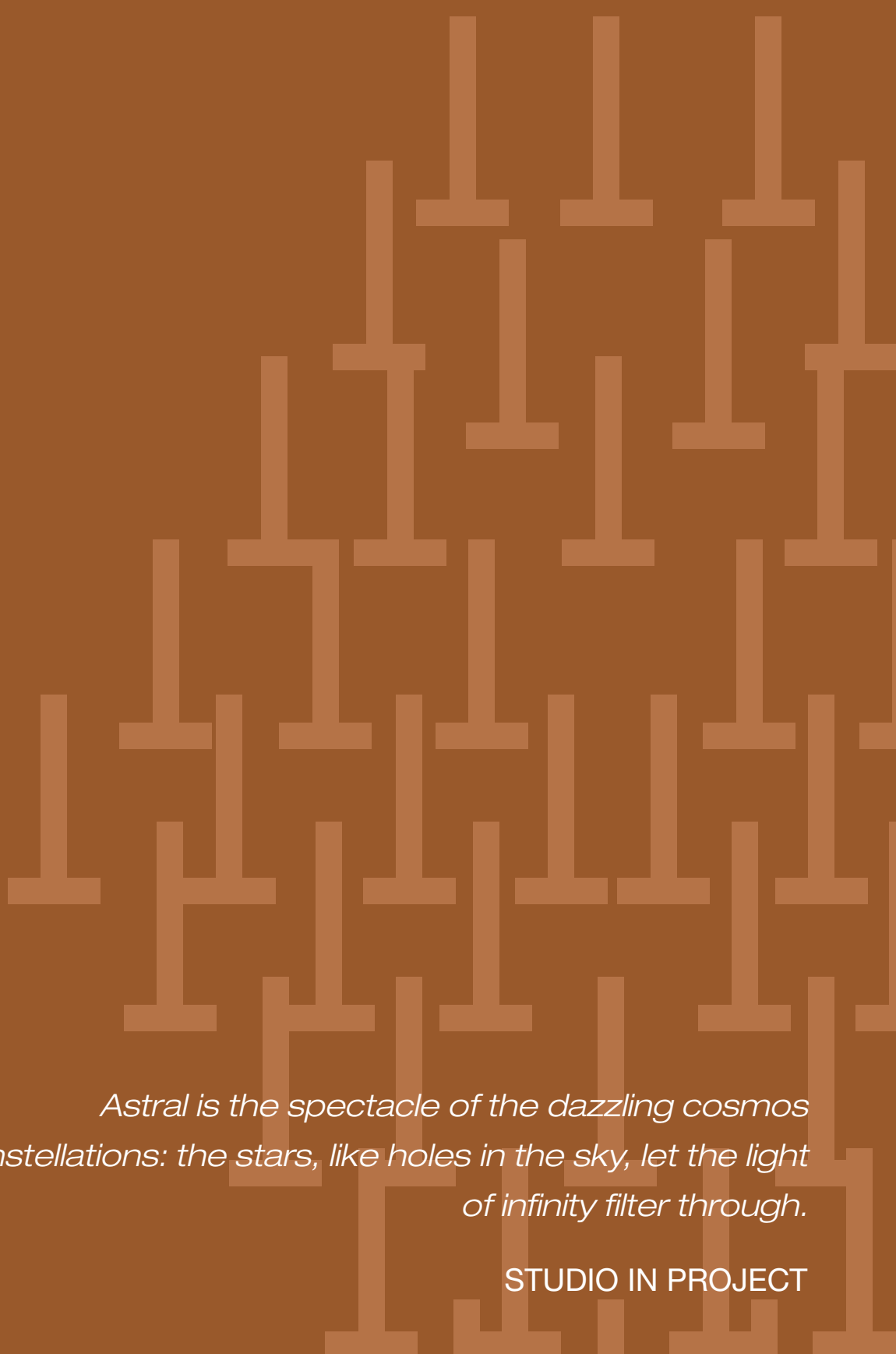

*Astral is the spectacle of the dazzling cosmos
with its constellations: the stars, like holes in the sky, let the light
of infinity filter through.*

STUDIO IN PROJECT

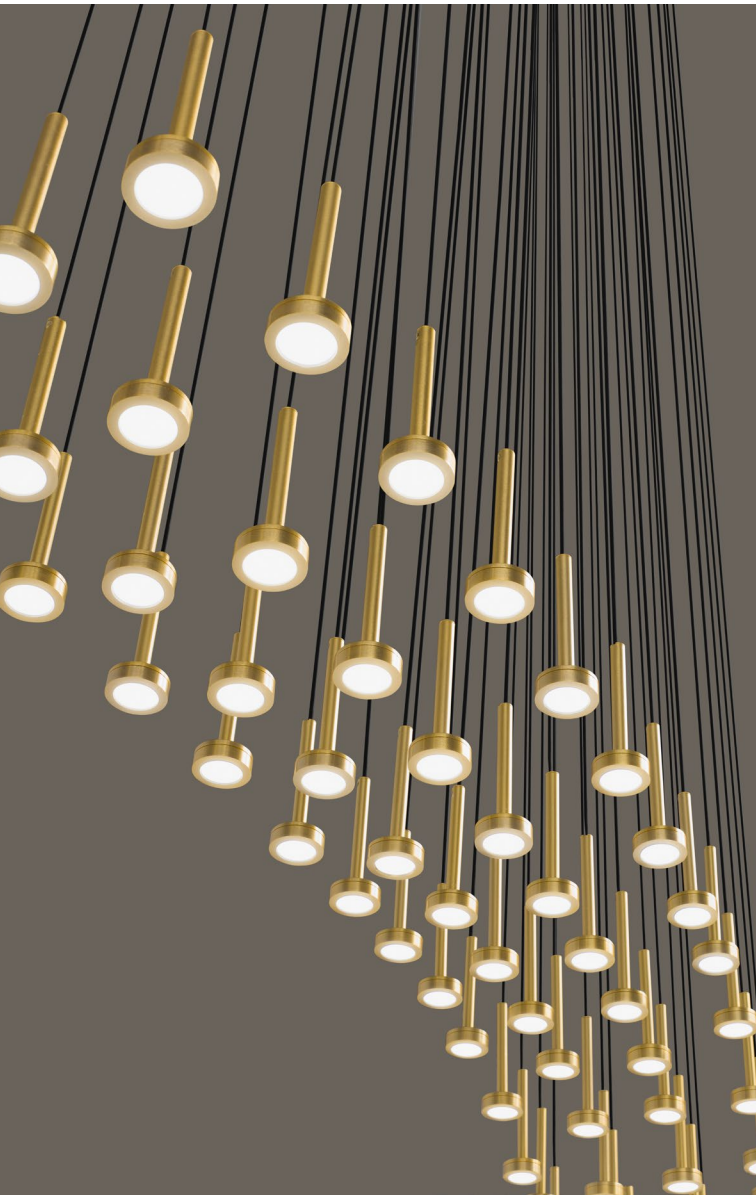

Astral project 84





Astral project - location: Relais S. Agostino - Italy

Astral chandelier 133

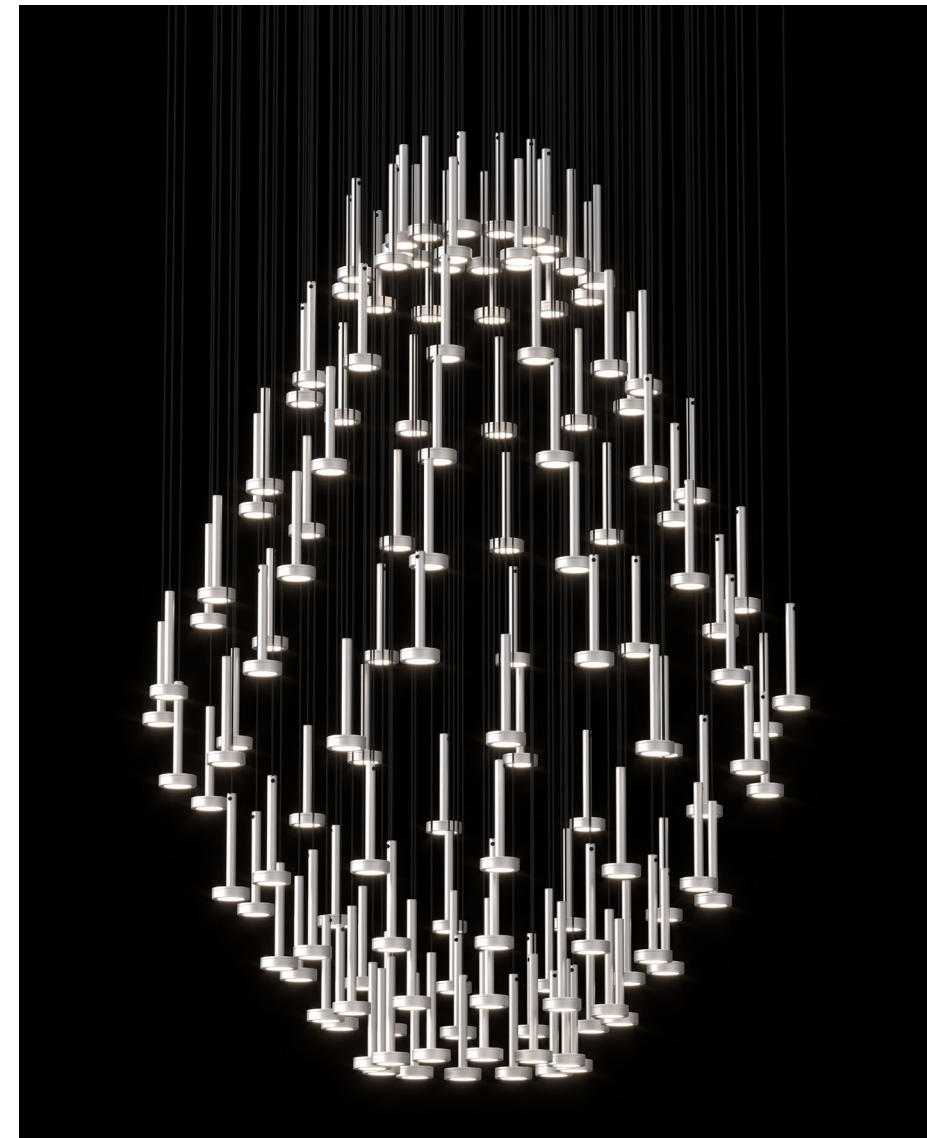

Astral chandelier project



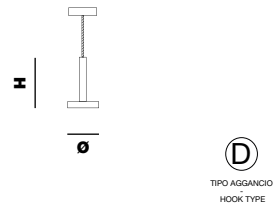

ASTRAL S1

Ø 6 cm | 2,36"
H 18 cm | 7,09"

1 spotted 3W - 4000°K - 12 Vdc - SMD 5630
280 lm - life time 30.000 hrs - Dimmable: yes

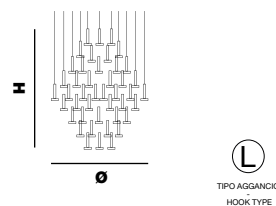

ASTRAL chandelier 133

Ø 110 cm | 43,31"
H 150 cm | 59,06"

133 spotted 399W - 4000°K - 12 Vdc - SMD 5630
37240 lm - life time 30.000 hrs - Dimmable: yes

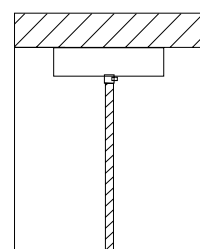

Altezza - Height
MIN 18 cm - 7.08"

(D) Aggancio con rosone o scatola a soffitto e cavo di alimentazione; altezza regolabile (D) - Hook with ceiling cup and power cord; adjustable height (D)

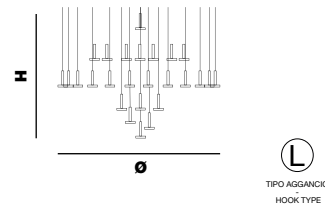

ASTRAL chandelier 52

Ø 100 cm | 39,37"
H 79 cm | 31,10"

52 spotted 156W - 4000°K - 12 Vdc - SMD 5630
14560 lm - life time 30.000 hrs - Dimmable: yes

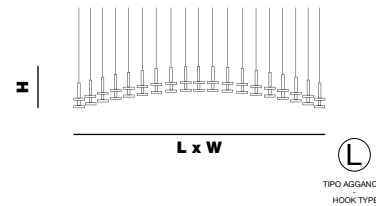

ASTRAL project 84

L x W 370 x 70 cm | 145,67" x 27,56"
H 40 cm | 15,75"

84 spotted 252W - 4000°K - 12 Vdc - SMD 5630
23520 lm - life time 30.000 hrs - Dimmable: yes

astral

Studio in Project

Particolari - Details

Faretto realizzato in alluminio su nostro disegno. Astral è già disponibile nelle misure indicate nei disegni. È possibile richiedere progetto esclusivo che si adatti al meglio ai vostri spazi e soddisfi le vostre esigenze. Per qualsiasi richiesta o differente versione non esitate a contattarci.

Spotlight made of aluminum according to our design. Astral is already available in the dimensions specified in the drawings. It is possible to request an exclusive project that best fits your spaces and meets your needs. For any inquiries or different versions, please do not hesitate to contact us.

Metalli - Metals

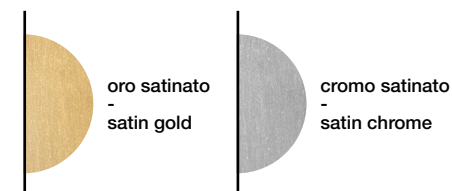

Plexiglass



* Specifiche agganci - Info on hooks pag. 345 *

* Altre finiture e colori su richiesta - Other finishes and colors on request - see pag. 347-348 *

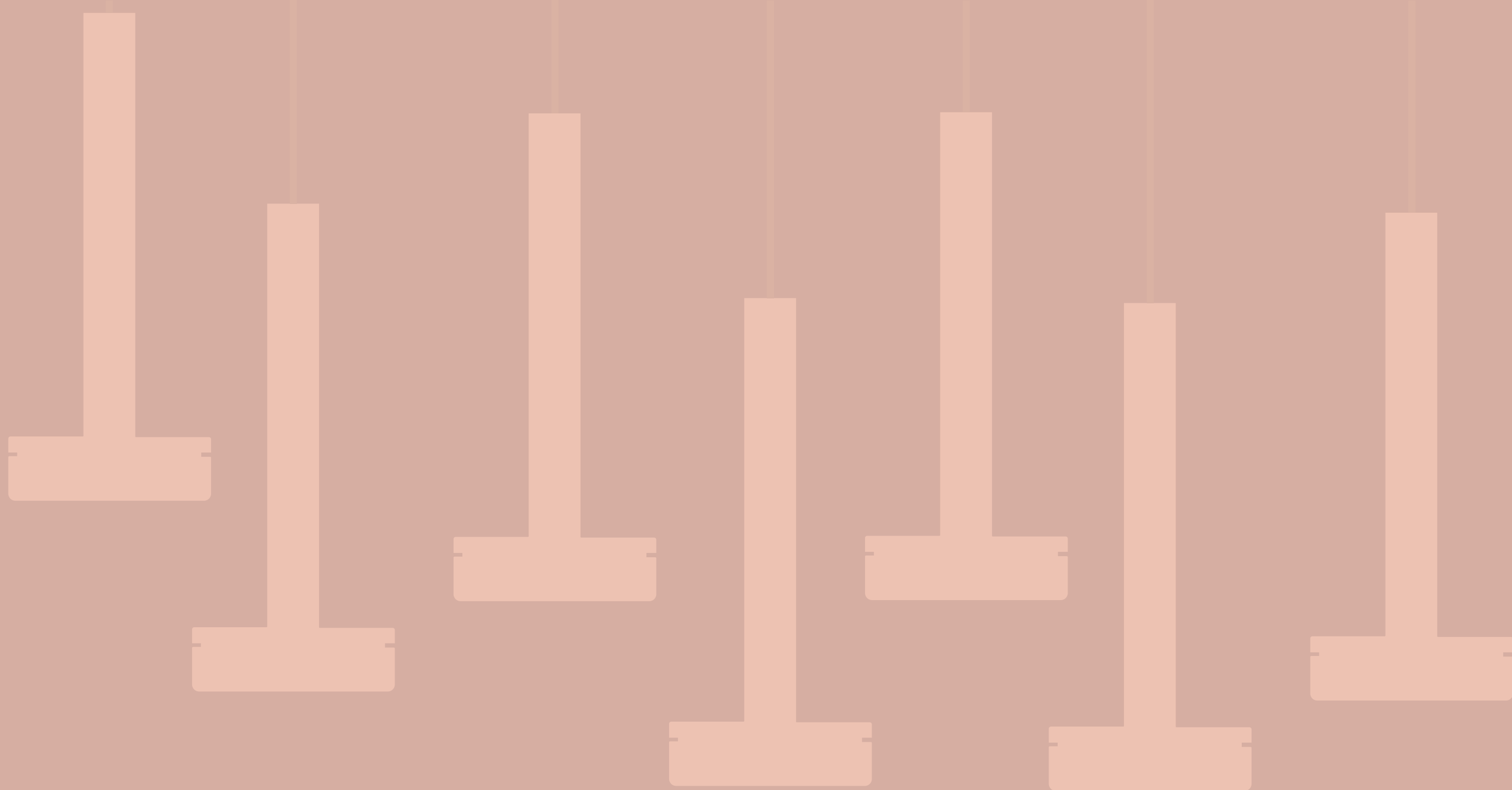

astral colors

Astral si adorna di tonalità cromatiche e dona un firmamento ricolmo di luminosi astri, come le serene notti estive.

STUDIO IN PROJECT

Astral is adorned with chromatic shades and gives a firmament full of bright stars, like the serene summer nights.

STUDIO IN PROJECT



RAL 5021

RAL 8011

RAL 8238

RAL 6003

RAL 3012





Astral colors S68





Astral colors S158



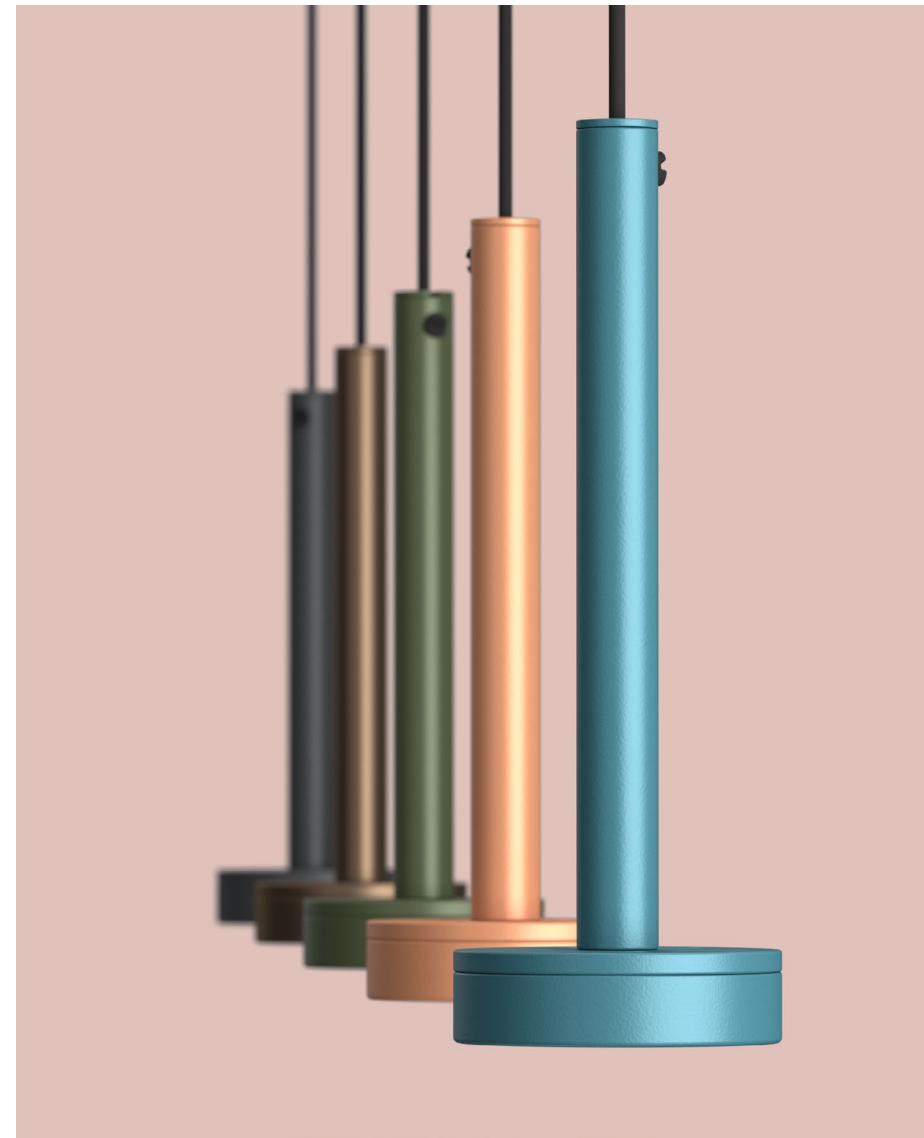

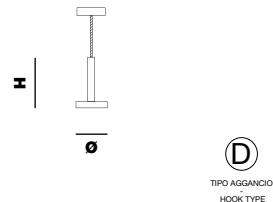

ASTRAL COOLORS S1

Ø 6 cm | 2,36"
H 18 cm | 7,09"

1 spotted 3W - 4000°K - 12 Vdc - SMD 5630
280 lm - life time 30.000 hrs - Dimmable: yes

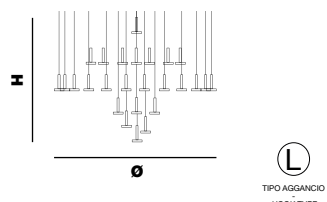

ASTRAL COOLORS chandelier 52

Ø 100 cm | 39,37"
H 79 cm | 31,10"

52 spotted 156W - 4000°K - 12 Vdc - SMD 5630
14560 lm - life time 30.000 hrs - Dimmable: yes

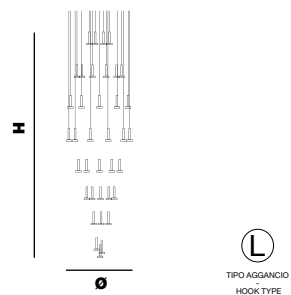

ASTRAL COOLORS S68

Ø 75 cm | 29,53"
H 265 cm | 104,33"

68 spotted 204W - 4000°K - 12 Vdc - SMD 5630
19040 lm - life time 30.000 hrs - Dimmable: yes

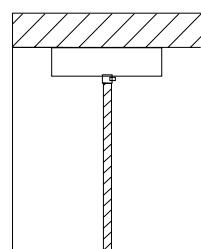

Altezza - Height
MIN 18 cm - 7.08"

(D) Aggancio con rosone o scatola a soffitto e cavo di alimentazione; altezza regolabile (D) - Hook with ceiling cup and power cord; adjustable height (D)

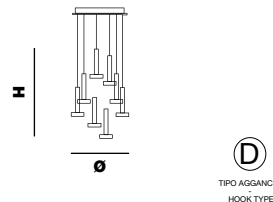

ASTRAL COOLORS S10

Ø 60 cm | 23,62"
H 45 cm | 17,72"

10 spotted 30W - 4000°K - 12 Vdc - SMD 5630
2800 lm - life time 30.000 hrs - Dimmable: yes

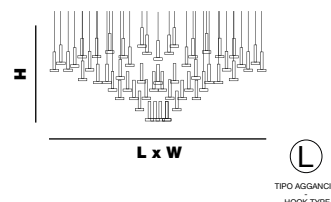

ASTRAL COOLORS S158

L x W 220 x 160 cm | 86,61" x 62,99"
H 90 cm | 35,43"

158 spotted 474W - 4000°K - 12 Vdc - SMD 5630
44220 lm - life time 30.000 hrs - Dimmable: yes

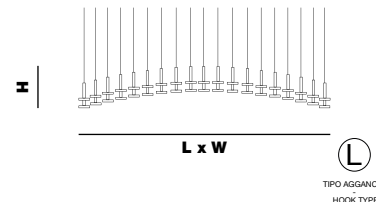

ASTRAL COOLORS project 84

L x W 370 x 70 cm | 145,67" x 27,56"
H 40 cm | 15,75"

84 spotted 252W - 4000°K - 12 Vdc - SMD 5630
23520 lm - life time 30.000 hrs - Dimmable: yes

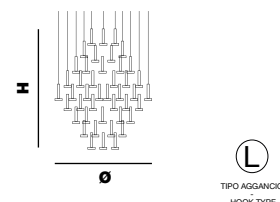

ASTRAL COOLORS chandelier 133

Ø 110 cm | 43,31"
H 150 cm | 59,06"

133 spotted 399W - 4000°K - 12 Vdc - SMD 5630
37240 lm - life time 30.000 hrs - Dimmable: yes

(L) Aggancio da definire (L)
Hooks to be defined (L)

* Specifiche agganci - Info on hooks pag. 345 *

astral colors

Studio in Project

Particolari - Details

Faretto realizzato in alluminio su nostro disegno. Astral colors è già disponibile nelle misure indicate nei disegni. È possibile richiedere progetto esclusivo che si adatti al meglio ai vostri spazi e soddisfi le vostre esigenze. Per qualsiasi richiesta o differente versione non esitate a contattarci.

Spotlight are produced in aluminum on our drawing. Astral colors is already available with sizes as technical drawings. It is possible to request an exclusive project that best fits your spaces and meets your needs. For any request or different version do not hesitate to contact us.

Metalli - Metals

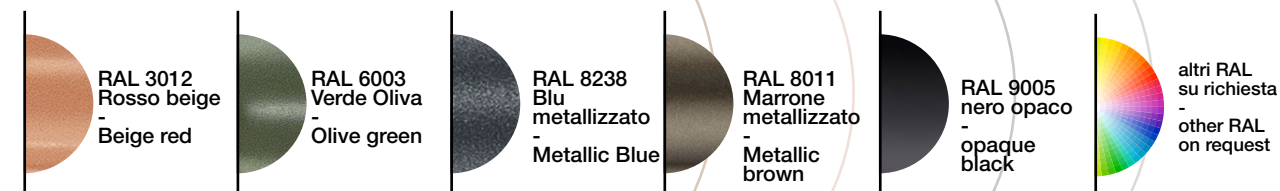

Plexiglass



Opalino
-
Opal

* Altre finiture e colori su richiesta - Other finishes and colors on request - see pag. 347-348 *



gocce

Come se la pioggia si fosse fermata nel tempo e nello spazio.

STUDIO IN PROJECT

As if the rain had stopped in time and space.

STUDIO IN PROJECT



Gocce linear

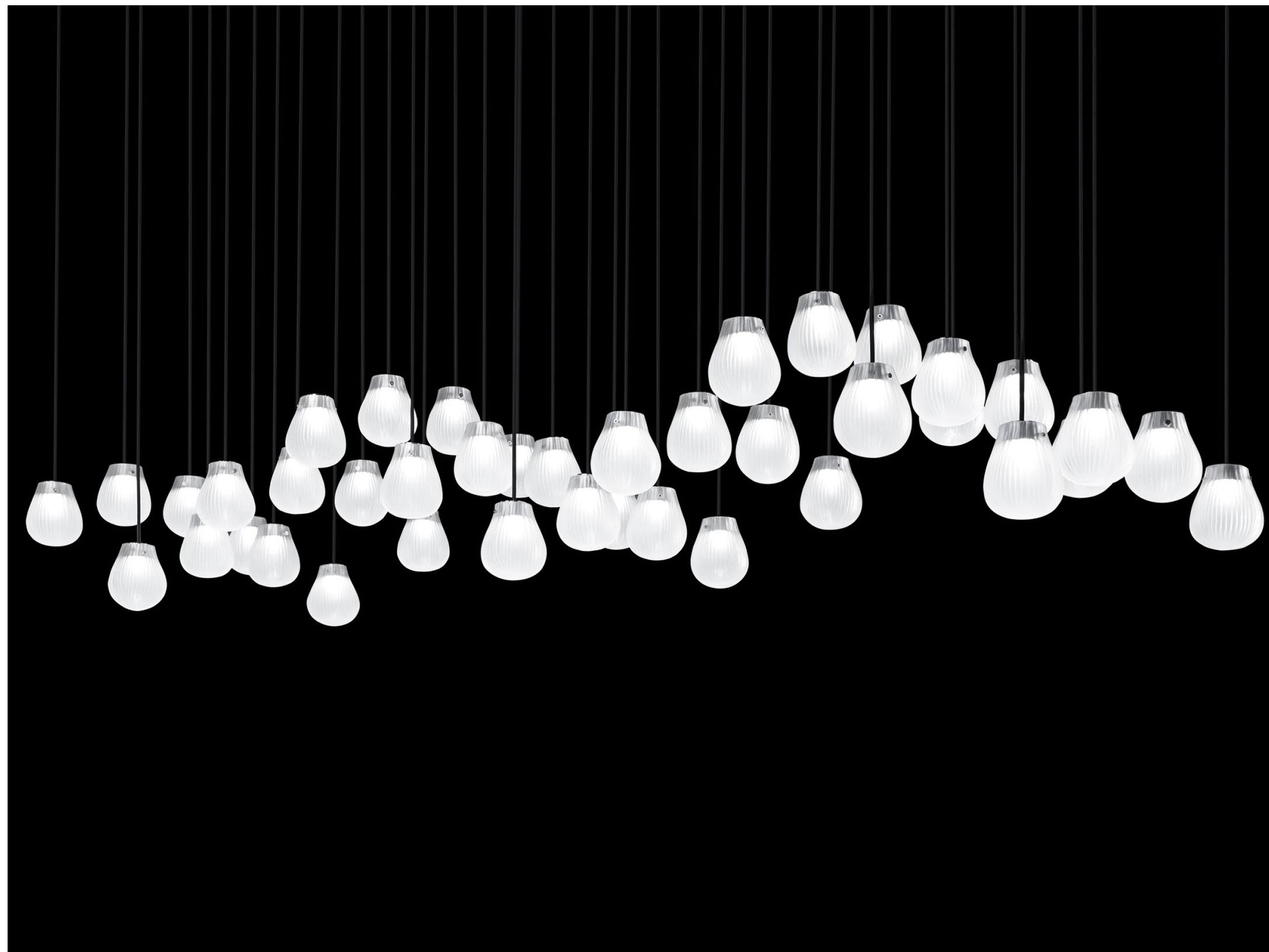



Gocce 60



Gocce linear





Gocce ellipse

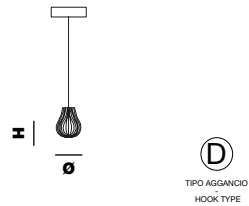

GOCCE S1

Ø 8 cm | 3,15"
H 10 cm | 3,94"

1 ledstar 4,5W - 4000°K - 12 Vdc - 440 lm
life time 20.000 hrs - SMD type Z5M2 - Dimmable: yes

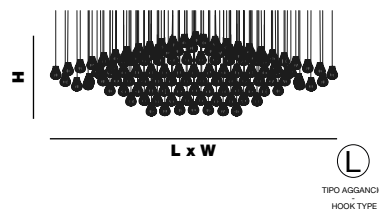

GOCCE ellipse

L x W 220 x 160 cm | 86,61" x 62,99"
H 95 cm | 37,40"

58 ledstar + 61 spotted 407W - 35820 lm - 4000°K
12 Vdc - life time 20.000 hrs - SMD type E219 | Z5M2
Dimmable: yes

58 luminous elements | 99 non luminous elements

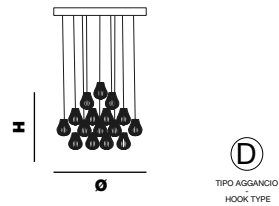

GOCCE 60

Ø 60 cm | 23,62"
H 45 cm | 17,72"

24 ledstar 108W - 4000°K - 12 Vdc - 10560 lm
life time 20.000 hrs - SMD type Z5M2 - Dimmable: yes

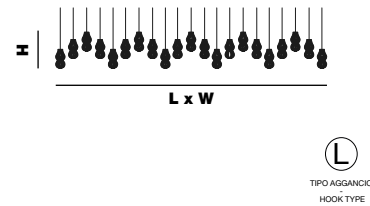

GOCCE linear

L x W 370 x 70 cm | 145,67" x 27,56"
H 40 cm | 15,75"

80 ledstar 360W - 4000°K - 12 Vdc - 35200 lm
life time 20.000 hr - SMD type Z5M2 - Dimmable: yes

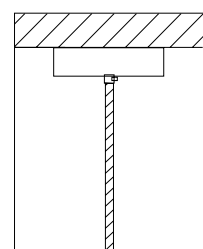

Altezza - Height
MIN 18 cm - 7.08"

(D) Aggancio con rosone o scatola a soffitto e cavo di alimentazione; altezza regolabile (D) - Hook with ceiling cup and power cord; adjustable height (D)

(L) Aggancio da definire (L) Hooks to be defined (L)

gocce

Studio in Project

Particolari - Details

Gocce in vetro di murano soffiate. Gocce è proposta come collezione personalizzabile:

- È possibile richiedere "versione movement", con sistema Casambi integrato, che consente il movimento delle luci secondo delle scene definite da remoto su smartphone, gestite con applicazione.
- È possibile richiedere progetto ad hoc, differenti dimensioni e configurazioni.
- È possibile richiedere progetto sospensione con elementi gocce luminose ed elementi gocce non luminose.

Esempio: Gocce ellipse. Non esitate a contattarci per un progetto esclusivo che si adatti al meglio ai vostri spazi e soddisfi le vostre esigenze.

Blown Murano glass drops. Gocce is proposed as a customizable collection:

- It is possible to request a "movement version", with an integrated Casambi system, which allows the movement of the lights according to the scenes defined remotely on a smartphone, managed with the application.
- It is possible to request ad hoc projects, different sizes and configurations.
- It is possible to request a suspension project with lighting drop elements and non-lighting drop elements.

Example: Gocce ellipse. Do not hesitate to contact us for an exclusive project that best suits your spaces and meets your needs.

Metalli - Metals

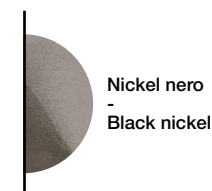

Nickel nero
- Black nickel

Vetro - Glass



Trasparente
- Transparent

Trasparente satinato
- Satin transparent

Ottanio
- Teal blue



Guarda il video

Watch video

* Specifiche agganci - Info on hooks pag. 345 *

* Altre finiture e colori su richiesta - Other finishes and colors on request - see pag. 347-348 *

neva

Un gruppo di lunghi ghiaccioli sospesi al tetto di una casa attraversati dalla bassa luce solare che infrange il ghiaccio creando un gioco cristallino di luce. Ecco fissato questo momento fugace per trasferirlo nello spazio di un'abitazione. Una sottile montatura in metallo crea il riferimento alla natura senza distrarre troppo dal gioco di luce dei vetri.

DANIEL BECKER

A group of long icicles suspended from the roof of a house crossed by low sunlight that shatters the ice, creating a crystal-clear pattern of light. This fleeting moment is frozen in time and transferred into the space of a home. A thin metal frame creates a reference to nature without distracting too much from the lighting effect created by the glass.

DANIEL BECKER



Neva A8



Neva A6

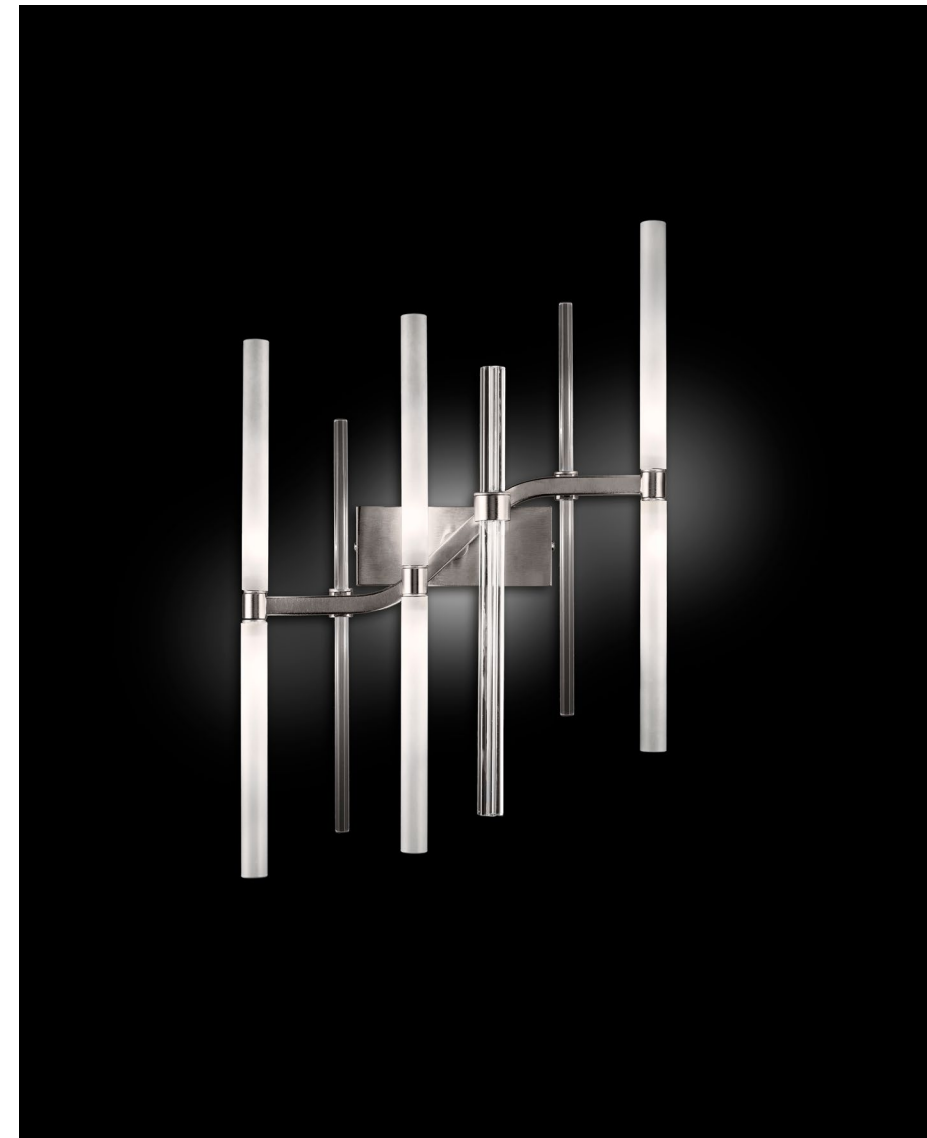

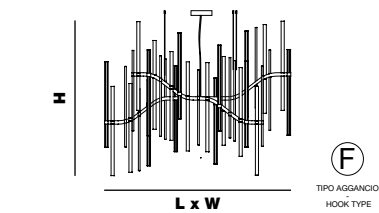

NEVA 24

L x W 113 x 36 cm | 44,49" x 14,17"
H 90 cm | 35,43"

24 G4 bulb 48W - 2700°K - 12 Vdc - 4800 lm
 life time 25.000 hrs - SMD type 550 - Dimmable: no

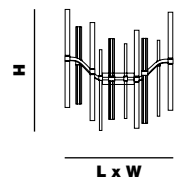

NEVA A8

L x W 44 x 18 cm | 17,32" x 7,09"
H 53 cm | 20,87"

8 G4 bulb 16W - 2700°K - 12 Vdc - 1600 lm
 life time 25.000 hrs - SMD type 550 - Dimmable: no

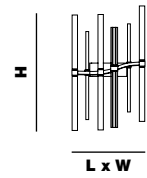

NEVA A6

L x W 32 x 9 cm | 12,60" x 3,54"
H 53 cm | 20,87"

6 G4 bulb 12 W - 2700°K - 12 Vdc - 1200 lm
 life time 25.000 hrs - SMD type 550 - Dimmable: no

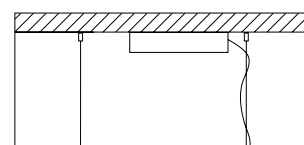

Altezza - Height
 MIN 24 cm - 9.44"



Aggancio con rosone, tiranti e tasselli a soffitto; altezza regolabile (F) - Hook with ceiling cup, metal cables and ceiling cable gripper; adjustable height (F)

neva

Daniel Becker

Particolari - Details

Strutture in ferro realizzate artigianalmente. Boccole in ottone tornito. Neva è composto da tubi porta luce in borosilicato, tubi stella in borosilicato e tubi pieni in vetro di Murano. Per qualsiasi richiesta o differente versione non esitate a contattarci.

The metal structure is produced handmade. Brass bushes. Neva has borosilicate bulb holder tubes, borosilicate tubes with stars section and full Murano glass tubes. Don't hesitate to contact us for any request or different version.

Metalli - Metals

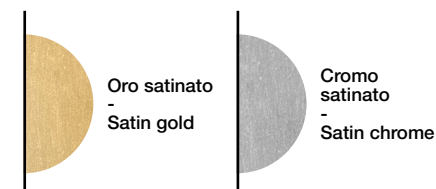

Vetro - Glass

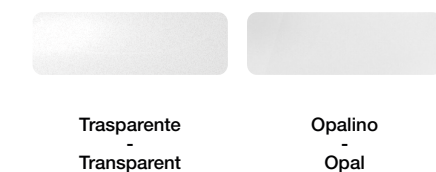

* Specifiche agganci - Info on hooks pag. 345 *

* Altre finiture e colori su richiesta - Other finishes and colors on request - see pag. 347-348 *



cryrock

*È affascinante l'universo con la sua energia.
Misterioso, buio eppure pieno di luci.*

MICHELE LOSITO

*The universe and its energy are fascinating.
Mysterious and dark, yet full of lights.*

MICHELE LOSITO





Cryrock S12



Cryrock lamp

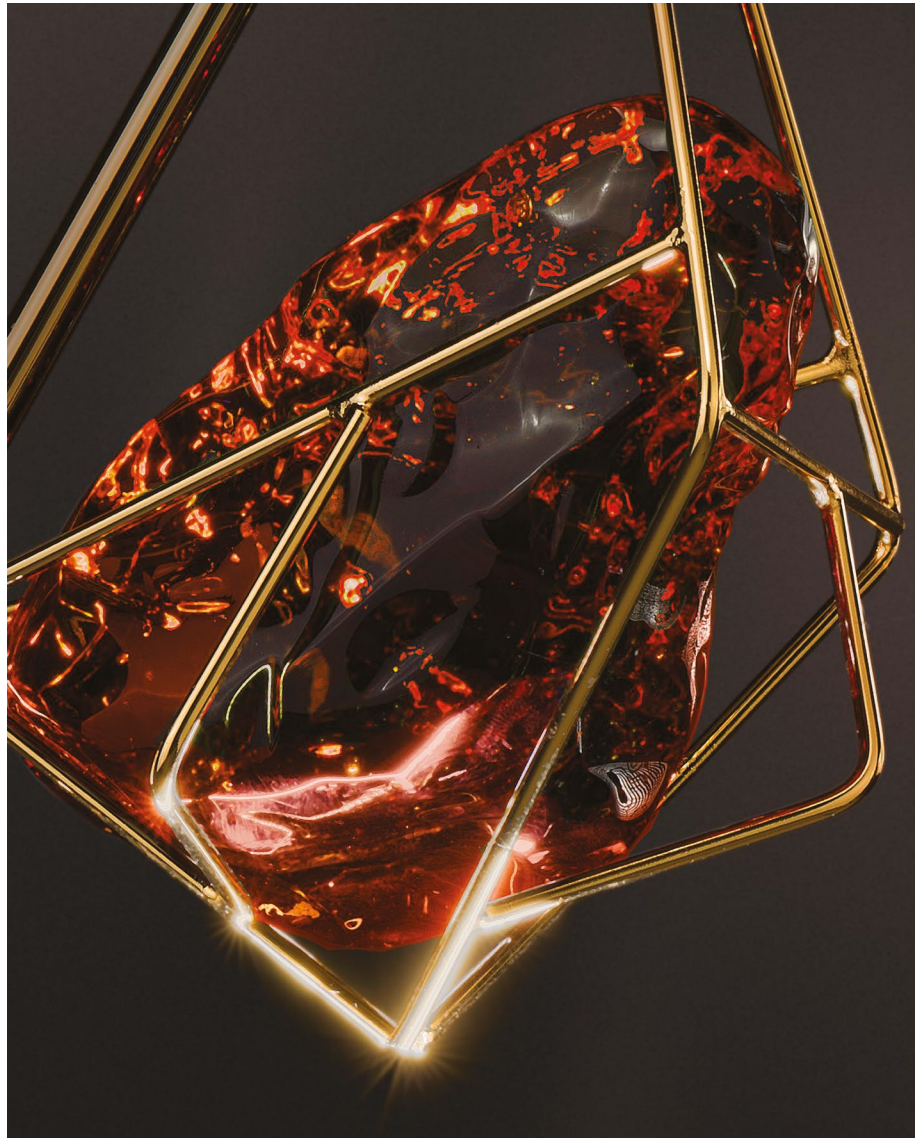

Cryrock wall lamp



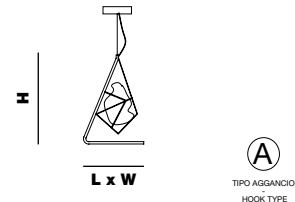

CRYROCK

L x W 17 x 15 cm | 6,69" x 5,91"
H 26 cm | 10,24"

1 tinylight 2W - 3500°K - 24 Vdc - 300 lm
 life time 20.000 hrs - SMD type fil - Dimmable: yes

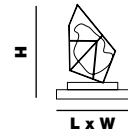

CRYROCK lamp

L x W 18 x 16 cm | 7,09" x 6,30"
H 28 cm | 11,02"

1 tinylight 2W - 3500°K - 24 Vdc - 300 lm
 life time 20.000 hrs - SMD type fil - Dimmable: yes

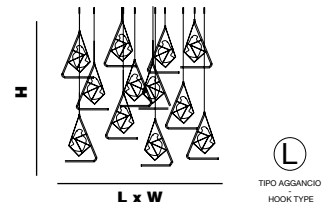

CRYROCK S12

L x W 130 x 50 cm | 51,18" x 19,69"
H 130 cm | 51,18"

12 tinylight 24W - 3500°K - 24 Vdc - 3600 lm
 life time 20.000 hrs - SMD type fil - Dimmable: yes

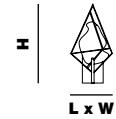

CRYROCK wall

L x W 15 x 18 cm | 5,91" x 7,09"
H 26 cm | 10,24"

1 tinylight 2W - 3500°K - 24 Vdc - 300 lm
 life time 20.000 hrs - SMD type fil - Dimmable: yes

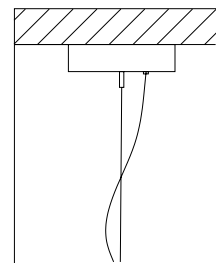

Altezza - Height
 MIN 18 cm - 7,08"

Aggancio con rosone o scatola in metallo e tirante in metallo; altezza regolabile (A)
 - Hook with ceiling cup or metal box and metal cable; adjustable height (A)



Aggancio da definire (L)
 Hooks to be defined (L)

cryrock

Michele Losito

Particolari - Details

Cryrock è una collezione brevettata. Il sasso in cristallo è made in Toscana, viene lavorato al fine di eliminare gli spigoli e arrotondarne le forme. Non subisce alcun lavoro di molatura e ciò consente un risultato unico e non riproducibile in serie. La struttura in metallo è realizzata artigianalmente su nostro disegno con saldature in argento. Il filamento Led illumina ed esalta il cristallo. La sospensione S12 è un esempio: è possibile richiedere differenti configurazioni, forme e numero di elementi. Per qualsiasi richiesta o differente versione non esitate a contattarci.

Cryrock is a patented collection. Crystal rock made in Tuscany. The rock is worked in order to smooth the edges off and to round its shape. It does not undergo any grinding work and this allows a unique result that can't be reproduced in series. The metal structure is handcrafted on our drawing with silver welds. The Led filament illuminates and highlights the crystal. The suspension S12 is an example: it's possible to request different configurations, shapes and number of elements. Don't hesitate to contact us for any request or different version.

Metalli - Metals



Oro lucido
 - Shiny gold

Vetro - Glass

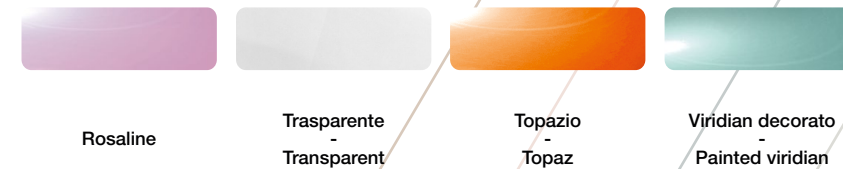

Rosaline

Trasparente
 - Transparent

Topazio
 - Topaz

Viridian decorato
 - Painted viridian

* Specifiche agganci - Info on hooks pag. 345 *

* Altre finiture e colori su richiesta - Other finishes and colors on request - see pag. 347-348 *

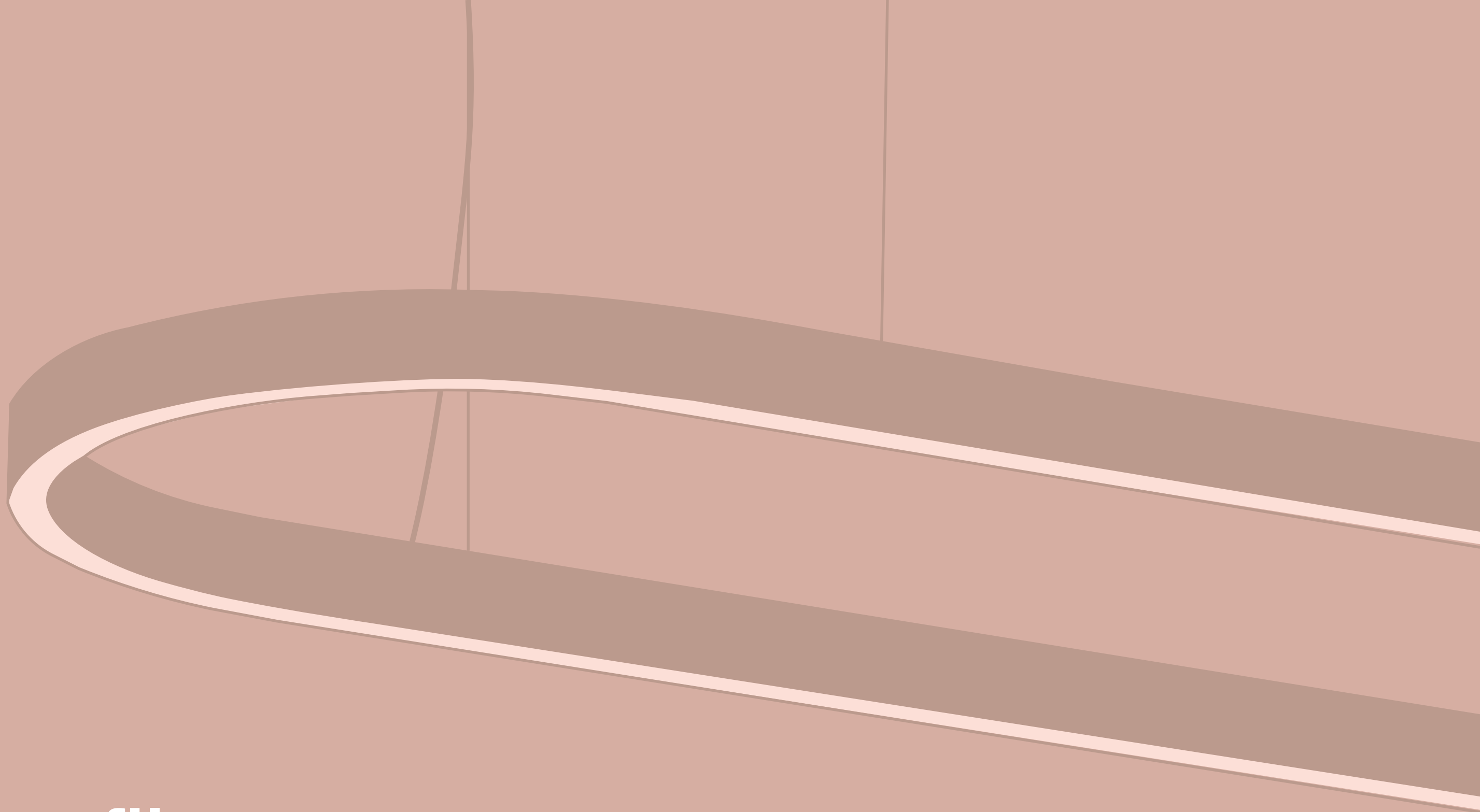

profile

*Il minimalismo che si materializza in una linea.
Il tratto essenziale che, però, connota in maniera
sostanziale l'espressione.*

STUDIO IN PROJECT

*Minimalism that materialises in a line.
The basic stroke that substantially
characterises the expression.*

STUDIO IN PROJECT

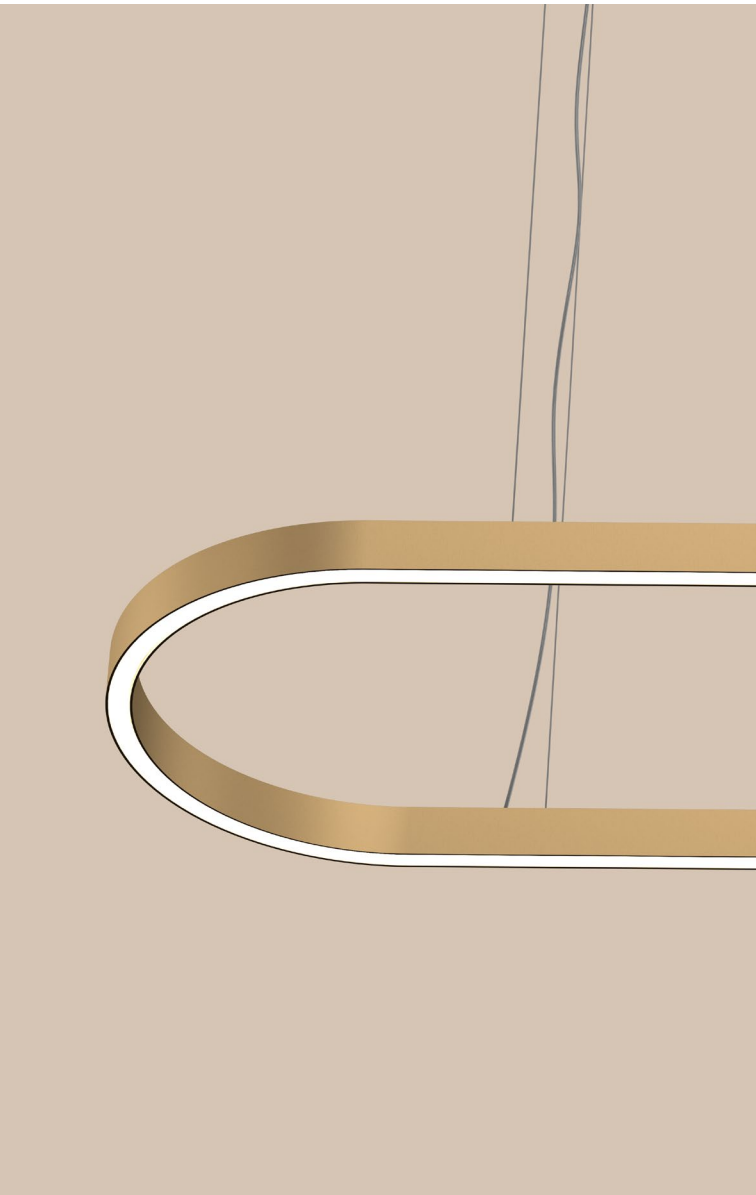

Profile oval 180 x 40



Profile oval 180 x 40





Profile project

Profile system up & down

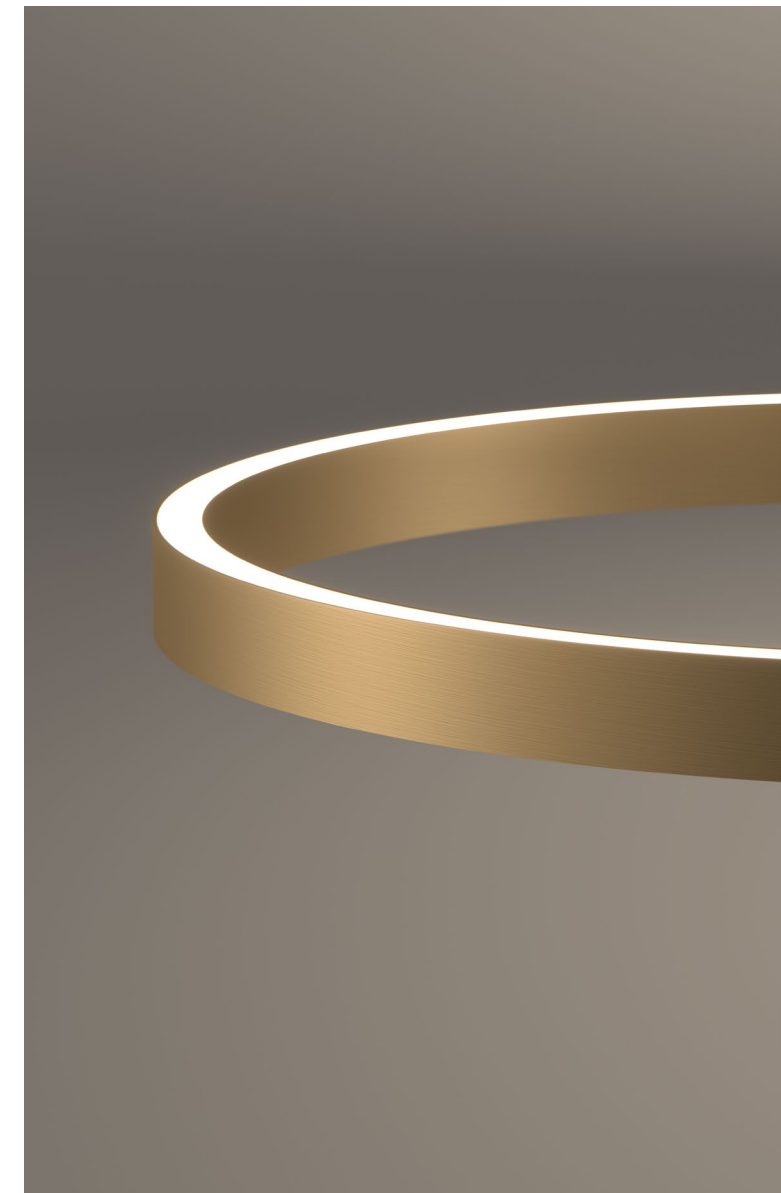

Profile system down



Profile project 130

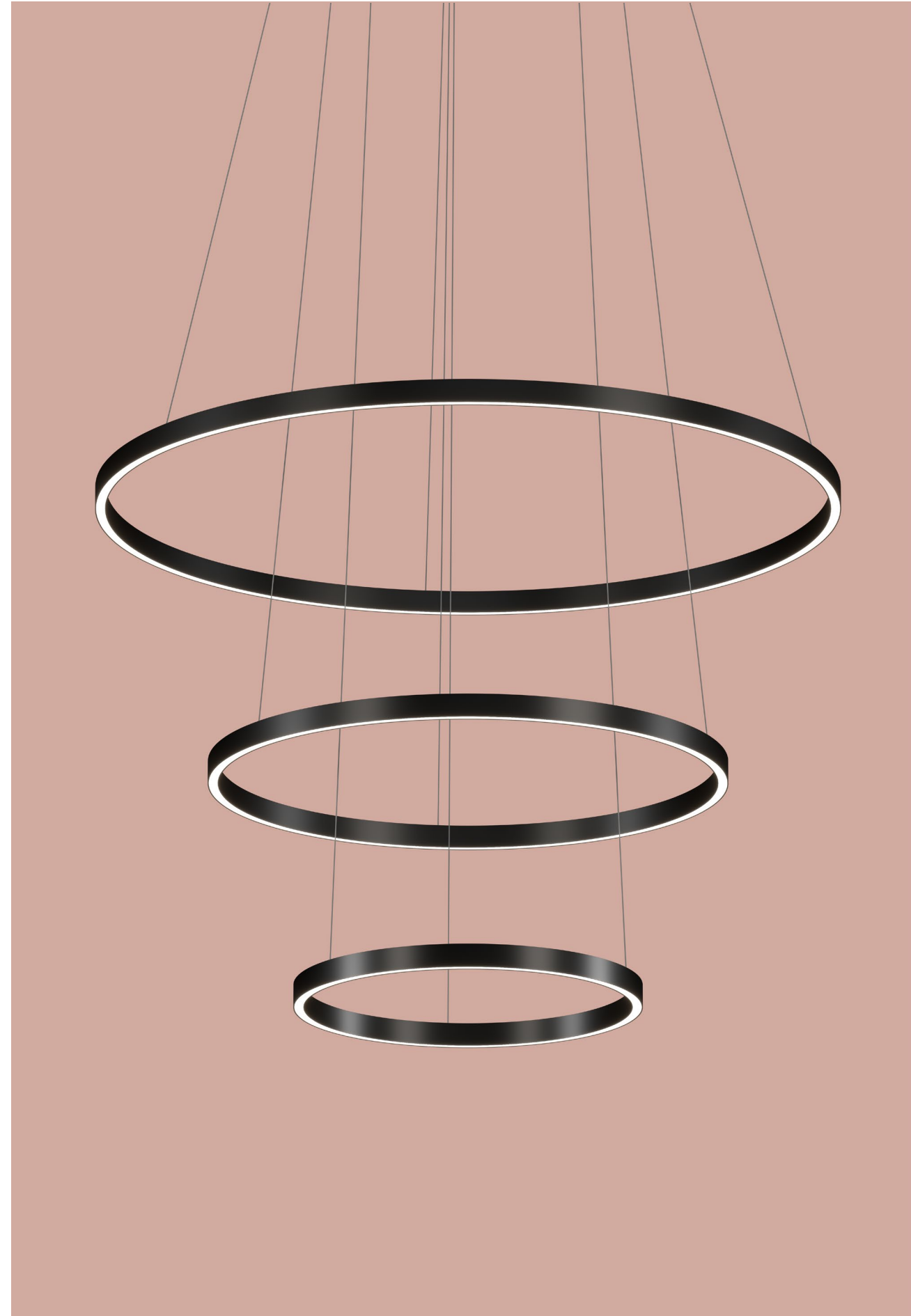

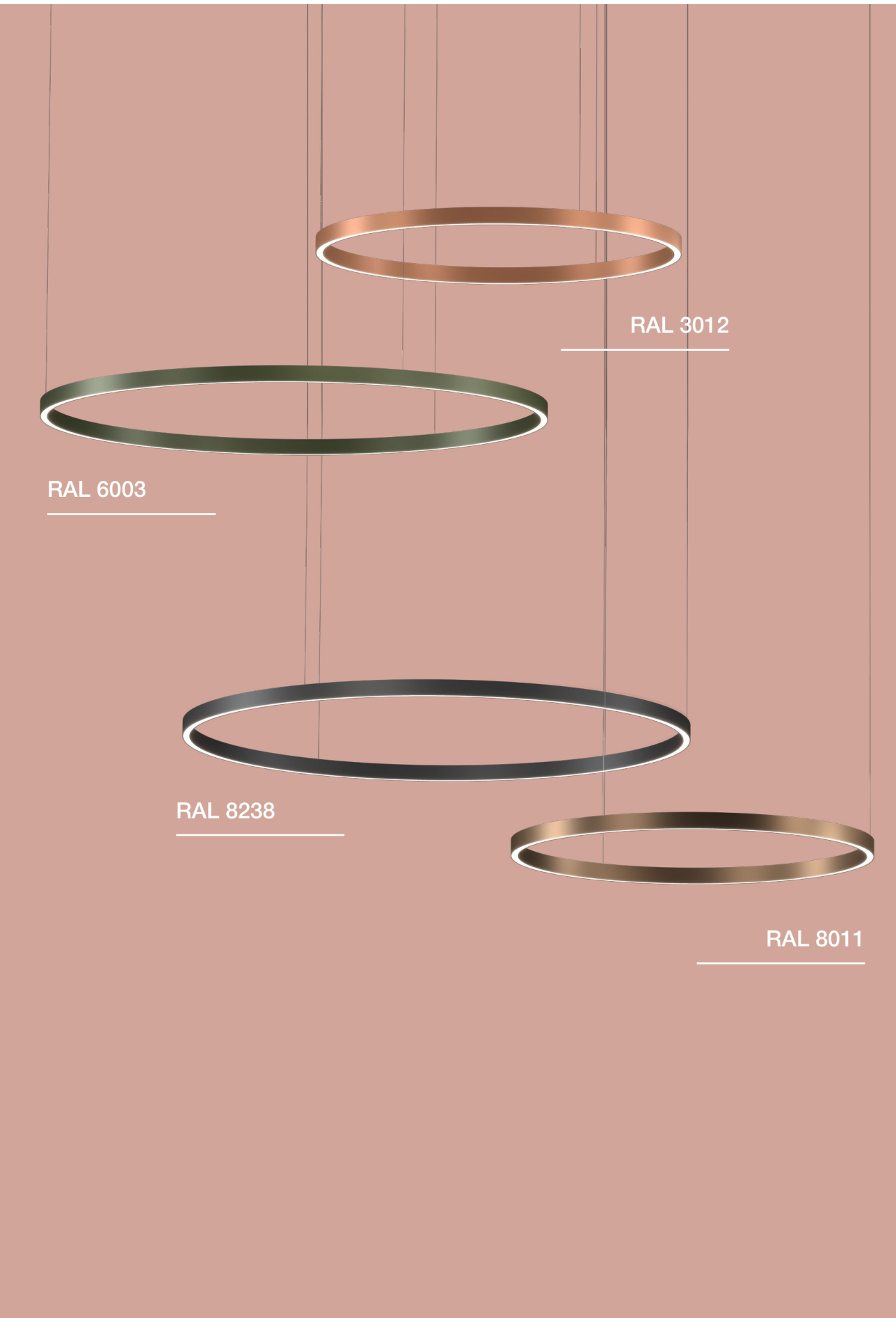

Profile colored version





274



Profile project

profile

TXXNTY BRAND DESIGN 24

275

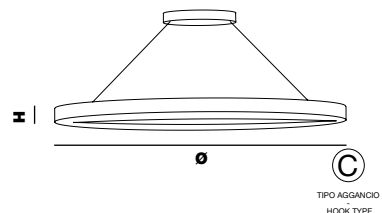

PROFILE 180

Ø 180 cm | 70,87"
H 4 cm | 1,57"

1 stripled 120W - 4000°K - 24 Vdc - SMD 2835
8506 lm - life time 50.000 hrs - Dimmable: yes

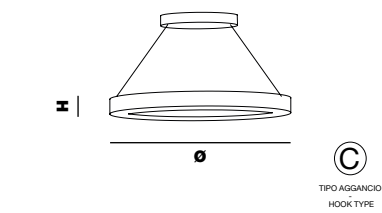

PROFILE 60

Ø 60 cm | 23,62"
H 4 cm | 1,57"

1 stripled 38W - 4000°K - 24 Vdc - SMD 2835
2835 lm - life time 50.000 hrs - Dimmable: yes

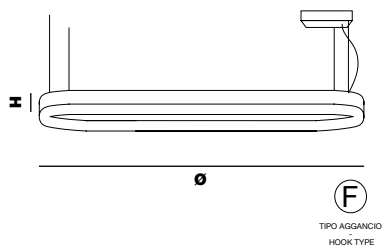

PROFILE oval 180 x 40

L x W 180 x 40 cm | 70,87" x 15,75"
H 4 cm | 1,57"

1 stripled 80W - 4000°K - 24 Vdc - SMD 2835
4900 lm - life time 50.000 hrs - Dimmable: yes

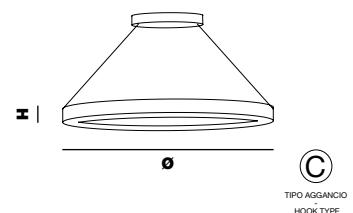

PROFILE 130

Ø 130 cm | 51,18"
H 4 cm | 1,57"

1 stripled 80W - 4000°K - 24 Vdc - SMD 2835
6143 lm - life time 50.000 hrs - Dimmable: yes

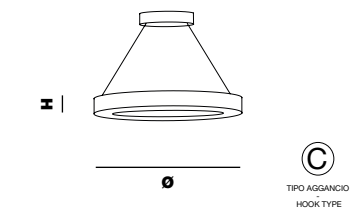

PROFILE 40

Ø 40 cm | 15,75"
H 4 cm | 1,57"

1 stripled 25W - 4000°K - 24 Vdc - SMD 2835
1890 lm - life time 50.000 hrs - Dimmable: yes

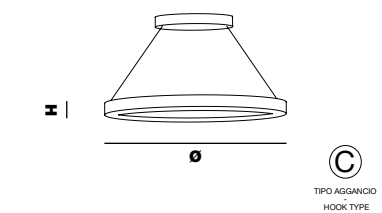

PROFILE 90

Ø 90 cm | 35,43"
H 4 cm | 1,57"

1 stripled 60W - 4000°K - 24 Vdc - SMD 2835
4253 lm - life time 50.000 hrs - Dimmable: yes

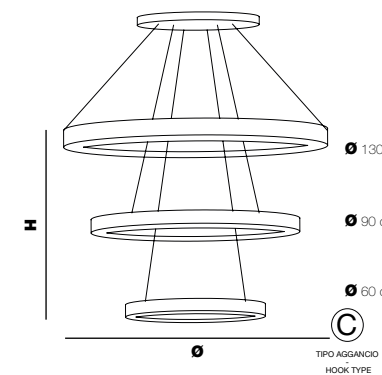

PROFILE project 130

Ø 130 cm | 51,18"
H 95 cm | 37,40"

1 stripled 178W - 4000°K - 24 Vdc - SMD 2835
13231 lm - life time 50.000 hrs - Dimmable: yes

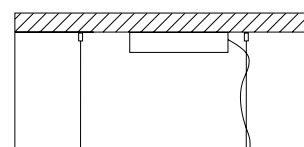

Altezza - Height
MIN 24 cm - 9.44"



Aggancio con rosone, tiranti e tasselli a soffitto; altezza regolabile (F) - Hook with ceiling cup, metal cables and ceiling cable gripper; adjustable height (F)

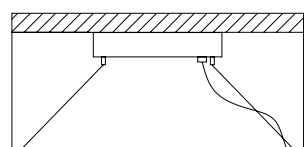

Altezza - Height
MIN 24 cm - 9.44"



Aggancio con rosone o scatola e tiranti per sospensioni. Altezza regolabile (C) - Hook with ceiling cup or metal box and metal cables for suspension. Adjustable height (C)

profile

Studio in Project

Particolari - Details

Strutture in alluminio realizzate artigianalmente. È possibile richiedere Profile monoluce con luce direzionata verso il basso "system down" o biluce con luce direzionata verso l'alto e verso il basso "system up & down". Per qualsiasi richiesta o differente versione non esitate a contattarci.

Aluminium structures made by hand. It is possible to request Profile monoluce with light directed downwards "system down" or double light directed upwards and downwards "system up & down". For any request or different version please contact us.

Metalli - Metals

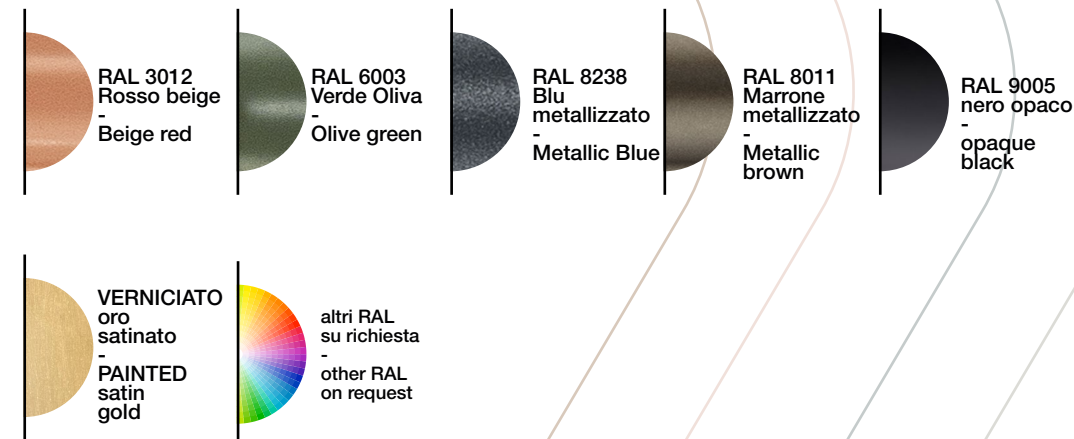

Silicone



* Specifiche agganci - Info on hooks pag. 345 *

* Altre finiture e colori su richiesta - Other finishes and colors on request - see pag. 347-348 *

The background features a series of overlapping circles and thick lines in shades of gray and beige. Three dark gray rectangular bars are positioned across the circles: one on the left, one in the middle, and one on the right. The overall composition is minimalist and geometric.

girasole

Come i girasoli che non si lasciano distrarre e sanno sempre da che parte guardare.

NUNZIA ACQUAVIVA

Like sunflowers that never allow themselves to be distracted and always know which way to look.

NUNZIA ACQUAVIVA



Girasole wall





Girasole 20

Girasole vertical





Girasole 40 | 30

Girasole 40



Girasole ceiling



Girasole horizontal



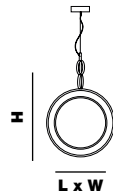

GIRASOLE 40

L x W 40 x 5 cm | 15,75" x 1,97"
H 60 cm | 23,62"

Stripled 22W - 4000°K - 24 Vdc - 1781 lm
life time 30.000 hrs - SMD type 2835 - Dimmable: yes

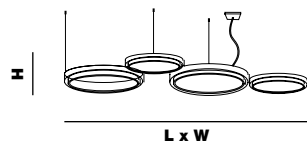

GIRASOLE horizontal

L x W 105 x 50 cm | 41,34" x 16,69"
H 5 cm | 1,97"

Stripled 56W - 4000°K - 24 Vdc - 4682 lm
life time 30.000 hrs - SMD type 2835 - Dimmable: yes

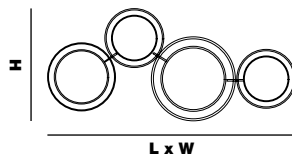

GIRASOLE wall

L x W 105 x 9 cm | 41,34" x 3,54"
H 50 cm | 16,69"

Stripled 56W - 4000°K - 24 Vdc - 4682 lm
life time 30.000 hrs - SMD type 2835 - Dimmable: yes

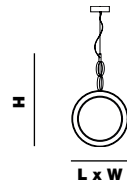

GIRASOLE 30

L x W 30 x 5 cm | 11,81" x 1,97"
H 48 cm | 18,90"

Stripled 16W - 4000°K - 24 Vdc - 1319 lm
life time 30.000 hrs - SMD type 2835 - Dimmable: yes

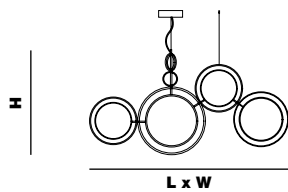

GIRASOLE vertical

L x W 105 x 5 cm | 41,34" x 1,97"
H 60 cm | 23,62"

Stripled 56W - 4000°K - 24 Vdc - 4682 lm
life time 30.000 hrs - SMD type 2835 - Dimmable: yes



GIRASOLE 20

L x W 20 x 5 cm | 7,87" x 1,97"
H 35 cm | 13,78"

Stripled 9W - 4000°K - 24 Vdc - 791 lm
life time 30.000 hrs - SMD type 2835 - Dimmable: yes

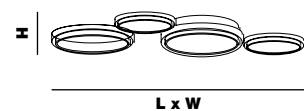

GIRASOLE ceiling

L x W 105 x 50 cm | 41,34" x 16,69"
H 9 cm | 3,54"

Stripled 56W - 4000°K - 24 Vdc - 4682 lm
life time 30.000 hrs - SMD type 2835 - Dimmable: yes

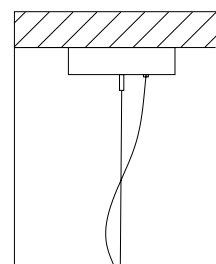

Altezza - Height
MIN 18 cm - 7.08"

Aggancio con rosone o scatola in metallo e tirante in metallo; altezza regolabile (A)
- Hook with ceiling cup or metal box and metal cable; adjustable height (A)

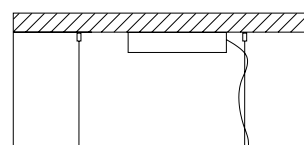

Altezza - Height
MIN 24 cm - 9.44"

Aggancio con rosone, tiranti e tasselli a soffitto; altezza regolabile (F) - Hook with ceiling cup, metal cables and ceiling cable gripper; adjustable height (F)

girasole

Nunzia Acquaviva

Particolari - Details

Strutture realizzate artigianalmente su nostro disegno. Dischi in vetro made in Veneto. Per qualsiasi richiesta o differente versione non esitate a contattarci.

Metal structures are produced handmade on our drawing. Glass disks made in Venice. Don't hesitate to contact us for any request or different version.

Metalli - Metals



Vetro - Glass

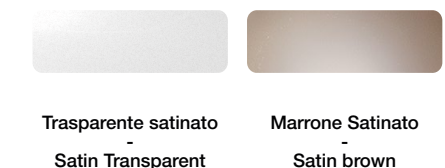

* Specifiche agganci - Info on hooks pag. 345 *

* Altre finiture e colori su richiesta - Other finishes and colors on request - see pag. 347-348 *

castel

L'alchimia della luce svela le sfaccettature dell'Architettura e la trasmuta in Design. La collezione si ispira all'architettura di Castel del Monte interpretando in chiave contemporanea un pezzo unico e singolare della tradizione architettonica pugliese. La geometria ottagonale, caratteristica peculiare di ogni lampada, riflette e assorbe le variazioni di luce e colore in una stanza: ogni faccia è sempre diversa dall'altra, e ognuna di esse cristallizza i cromatismi cangianti degli ambienti che lo circondano.

VINCENZO BAFUNNO

The alchemy of light reveals the facets of Architecture and transposes them into Design. The collection is inspired by the architecture of Castel del Monte, offering a contemporary interpretation of a unique and singular piece of Apulian architectural tradition. The octagonal geometry, which is a particular feature of each lamp, reflects and absorbs the fluctuations of light and colour in a room: every face is always different from the other, and each one crystallizes the iridescent colours of the rooms around it.

VINCENZO BAFUNNO



Castel S16





Castel S1 big

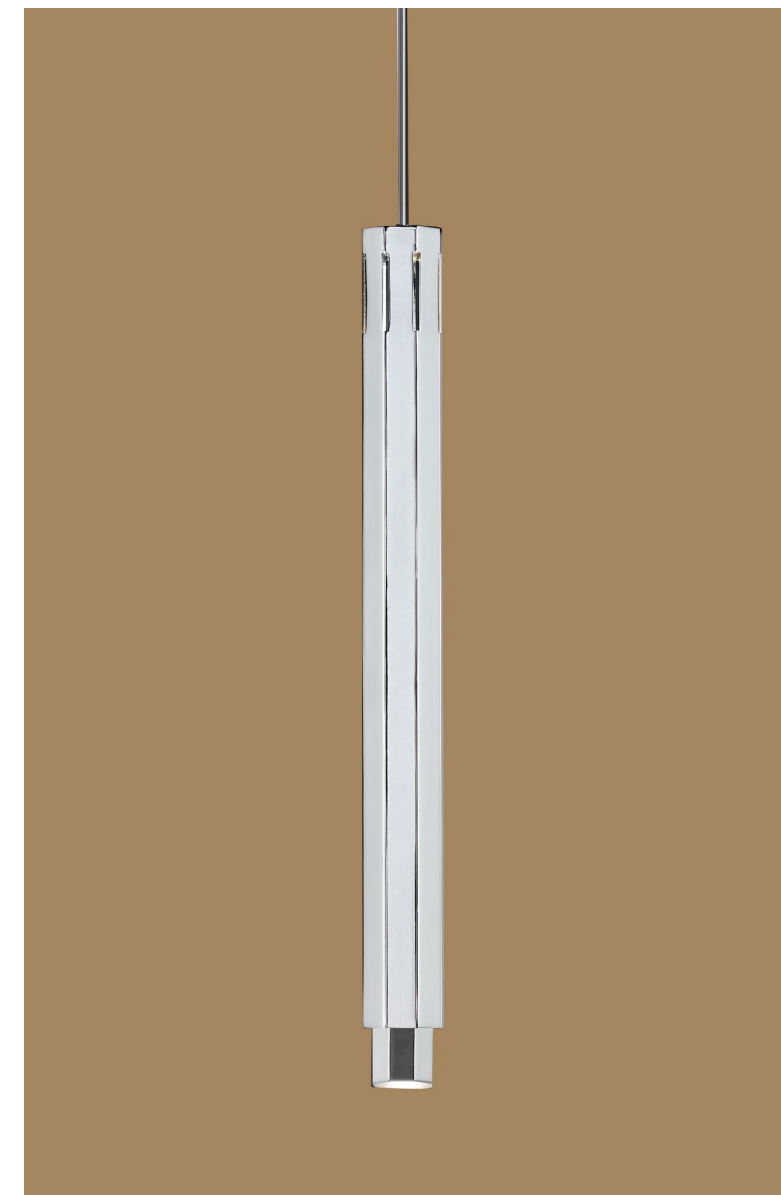

295



Castel S4 small





Castel wall lamp



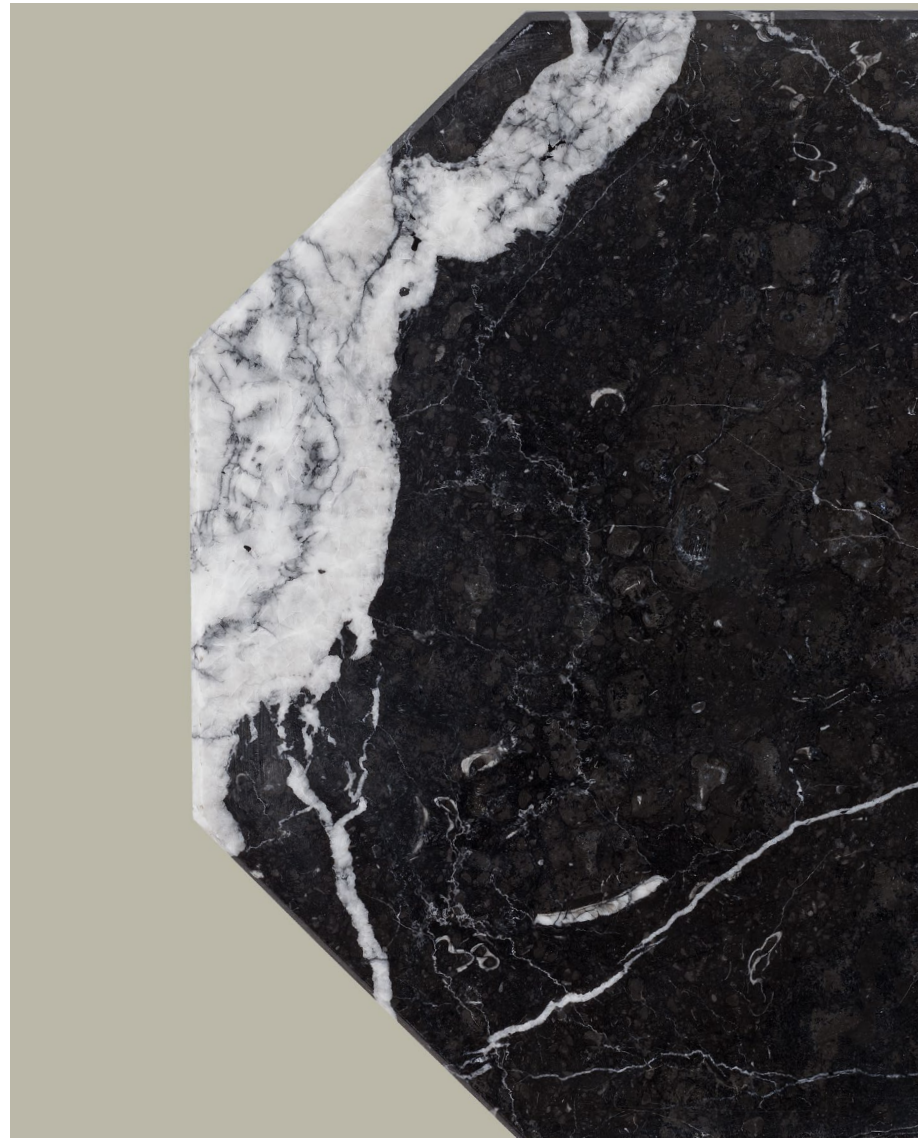

Castel lamp





302

castel

Castel tall lamp



TXXNTY BRAND DESIGN 24

303

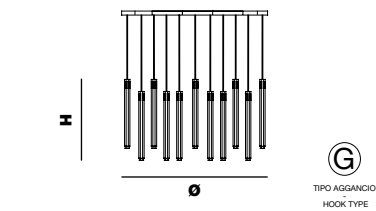

CASTEL S16

Ø 105 cm | 41,34"
H 90 cm | 35,43"

32 spot led 144W - 4000°K - 12 Vdc - 8960 lm
life time 30.000 hrs - SMD type 5630 - Dimmable: yes

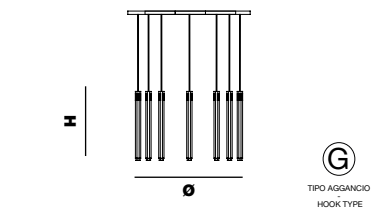

CASTEL S8

Ø 70 cm | 27,56"
H 60 cm | 23,62"

16 spot led 48W - 4000°K - 12 Vdc - 4480 lm
life time 30.000 hrs - SMD type 5630 - Dimmable: yes

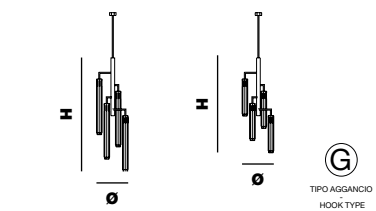

CASTEL S4 big & small

Ø 35 cm | 13,78" H 110 cm | 43,31"
H 84 cm | 33,07"

8 spot led 36W - 4000°K - 24 Vdc - 2240 lm
life time 30.000 hrs - SMD type 5630 - Dimmable: yes

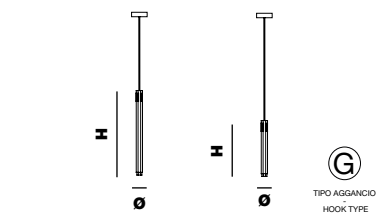

CASTEL S1 big - CASTEL S1 small

Ø 6 cm | 2,36" H 60 cm | 23,62"
H 40 cm | 15,75"

2 spotted - 6W - 4000°K - 12 Vdc - SMD 5630
560 lm - life time 30.000 hrs - Dimmable: yes

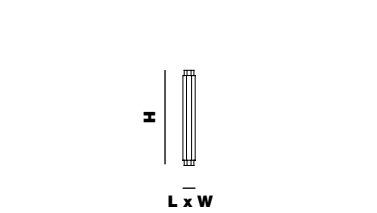

CASTEL wall

L x W 6 x 9 cm | 2,36" x 3,54"
H 28 cm | 11,02"

2 spot led 6W - 4000°K - 220 Vdc - 560 lm
life time 30.000 hrs - SMD type 5630 - Dimmable: yes

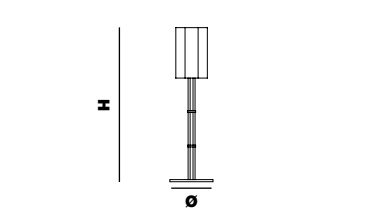

CASTEL floor lamp

Ø 40 cm | 15,75"
H 180 cm | 70,87"

1 bulb E27 x max 40W

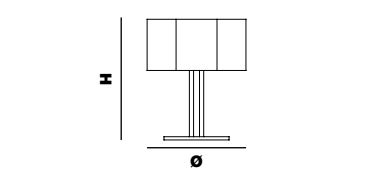

CASTEL lamp

Ø 40 cm | 15,75"
H 58 cm | 22,83"

1 bulb E27 x max 40W

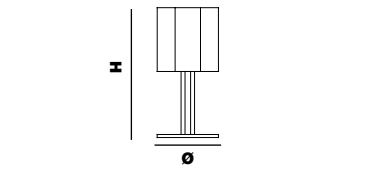

CASTEL tall lamp

Ø 21 cm | 8,27"
H 70 cm | 27,56"

1 bulb E27 x max 40W

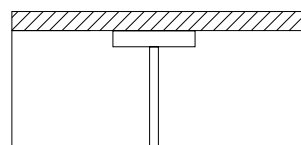

Altezza - Height
MIN 15 cm - 5,91"

Aggancio con altezza fissa. Specificare
altezza desiderata. Altezza non regolabile
- Hook with fixed height. Specify desired
height. Non-adjustable height (G)

* Specifiche agganci - Info on hooks pag. 345 *

castel

Vincenzo Bafunno

Particolari - Details

Struttura dalla forma ottagonale realizzata artigianalmente. Castel sospensione è dotato di doppia fonte luminosa led: luce diretta verso il basso e luce di atmosfera verso l'alto che ricrea un gioco di riflessi ottagonali. Le basi delle lampade sono in marmo sagomato. Per qualsiasi richiesta o differente versione non esitate a contattarci.

Octagonal structure is produced handmade. Castel suspension has a double led light source: the direct light downwards and the atmosphere light upwards. The atmosphere light creates octagonal reflections. The lamp bases are in shaped marble material. Don't hesitate to contact us for any request or different version.

Metalli - Metals

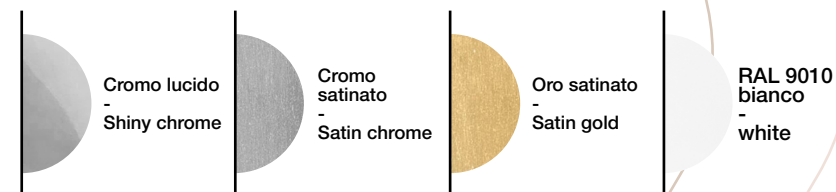

Marmo - Marble

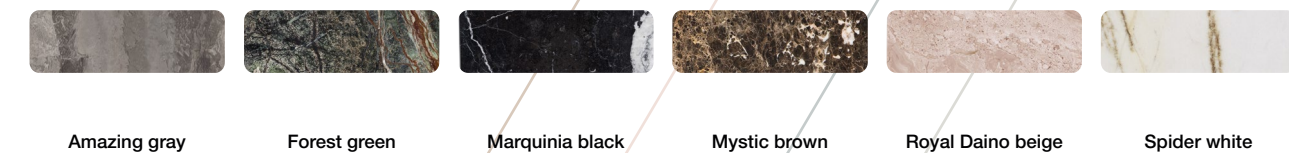

* Altre finiture e colori su richiesta - Other finishes and colors on request - see pag. 347-348 *



rhythm

Forme in movimento, alternanza di suoni o di momenti di luce e ombra, di azioni e pause: sorprendersi a pensare quando tutto sembra così lineare.

MICHELE LOSITO

Shapes in motion, alternating sounds or moments of light and shade, actions and pauses: surprise yourself by thinking when everything seems so linear.

MICHELE LOSITO

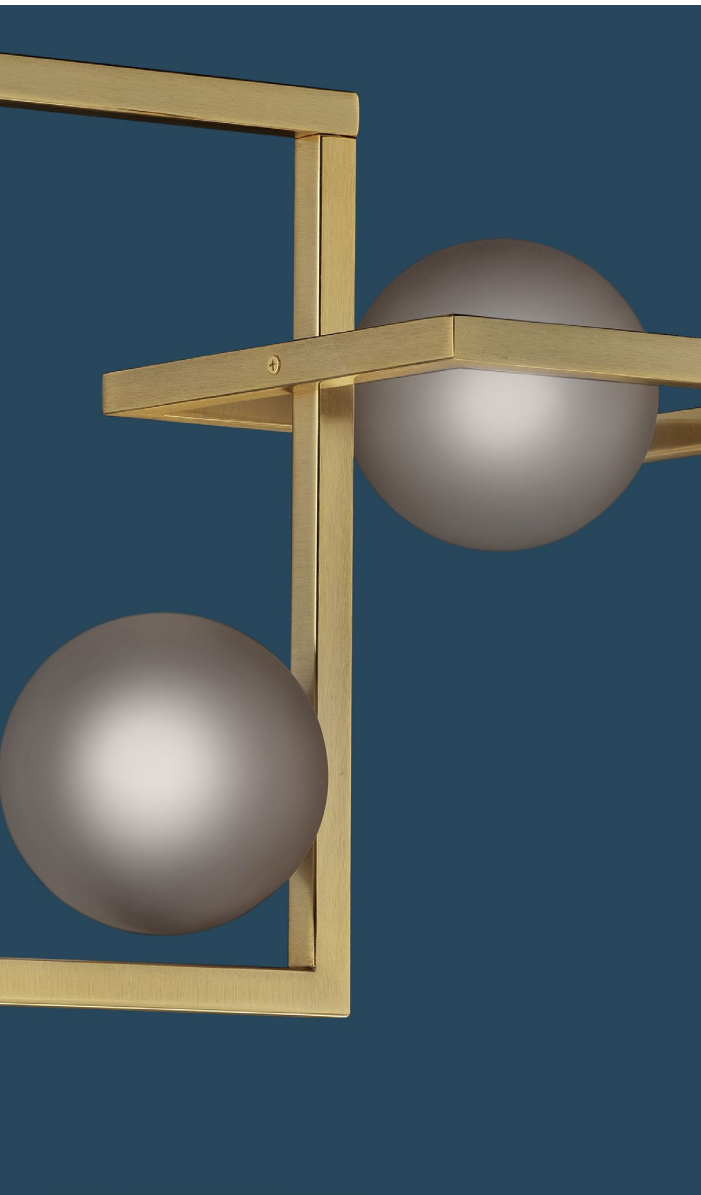

Rhythm 4



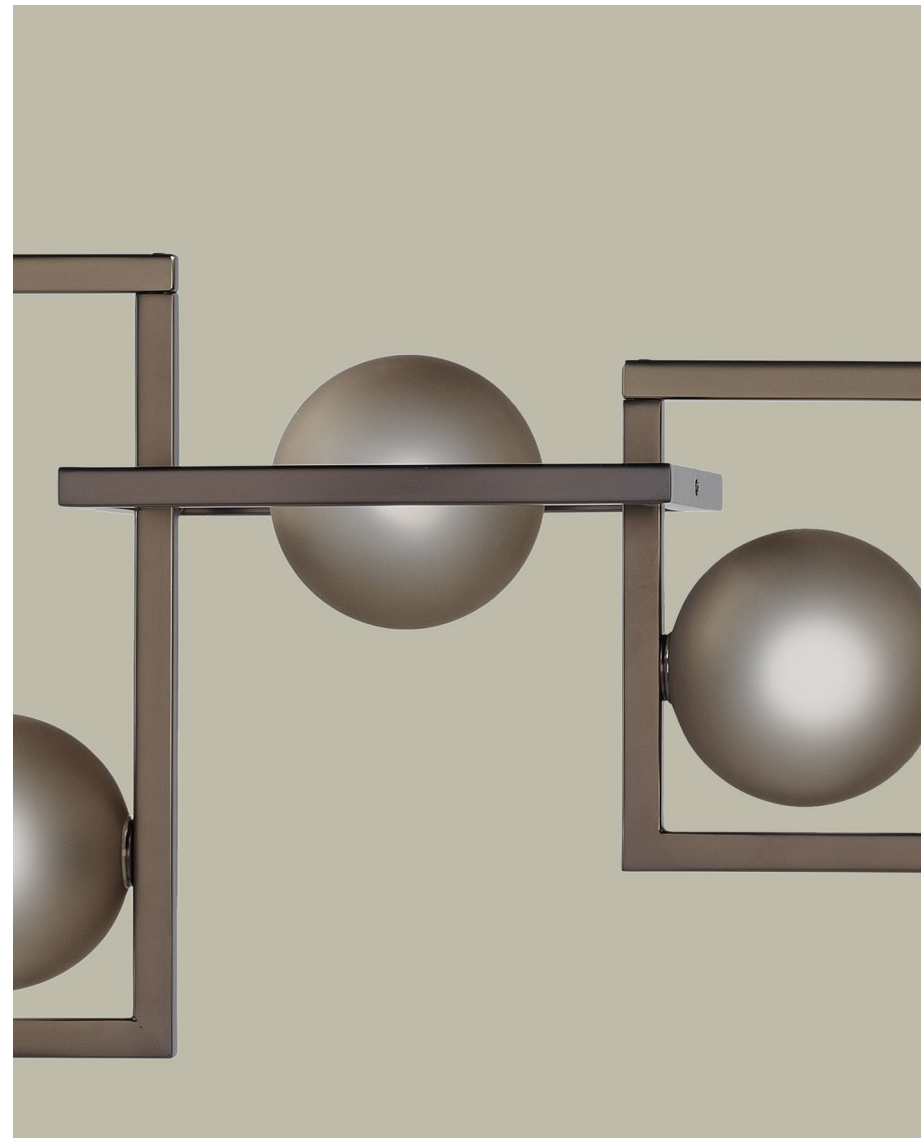

Rhythm lamp small | big



Rhythm wall lamp

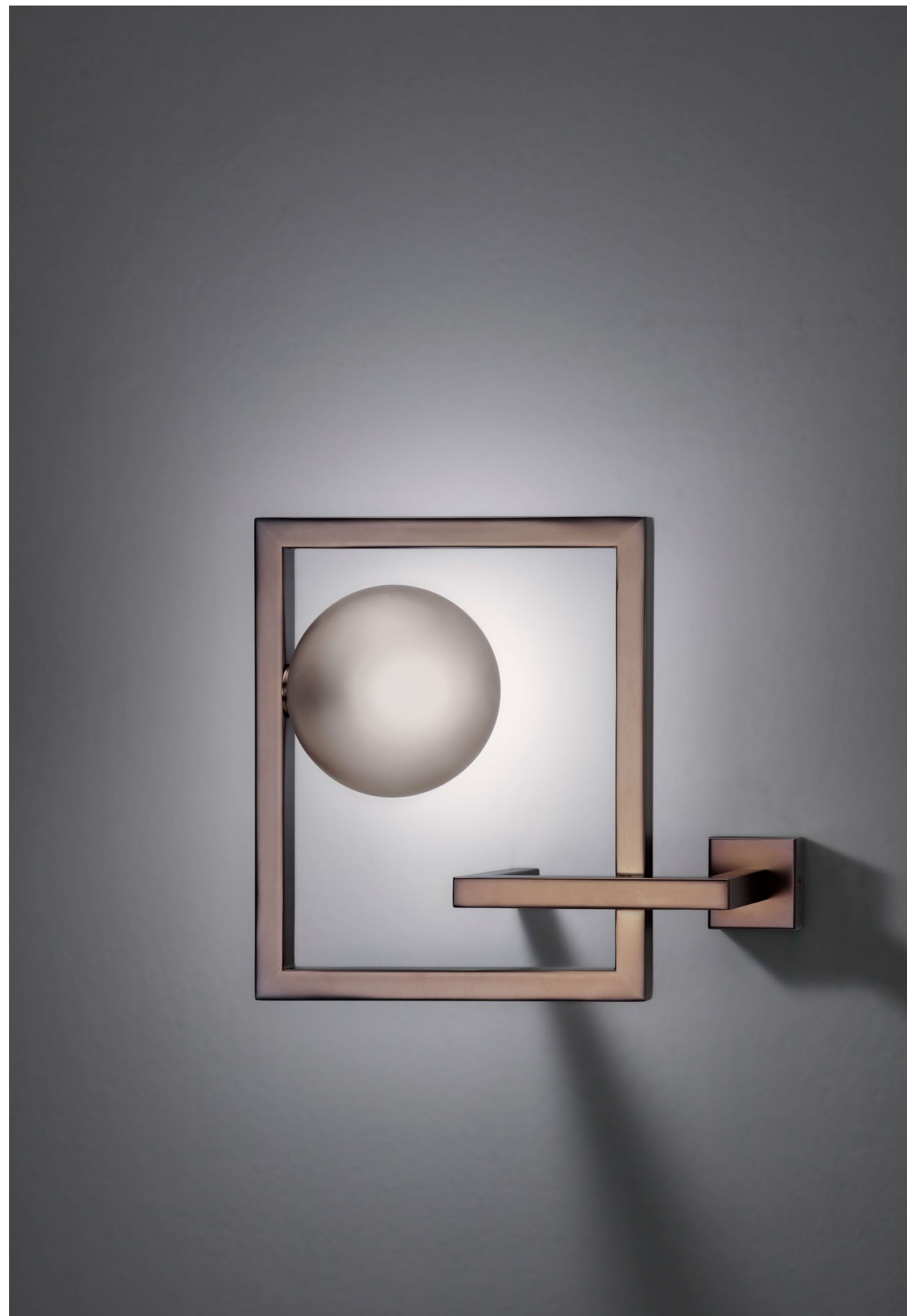



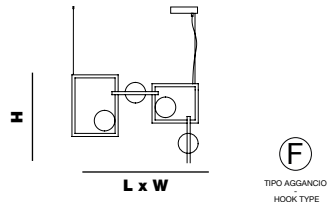

RHYTHM 4

L x W 74 x 23 cm | 29,13" x 9,06"
H 51 cm | 20,08"

4 G9 x max 7W - 220 Vdc

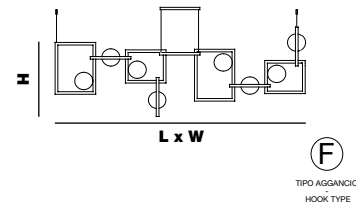

RHYTHM 8

L x W 168 x 23 cm | 66,14" x 9,06"
H 64 cm | 25,20"

8 G9 x max 7W - 220 Vdc

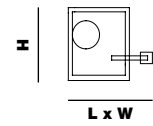

RHYTHM wall

L x W 30 x 16 cm | 11,81" x 6,30"
H 27 cm | 10,63"

1 G9 x max 7W - 220 Vdc

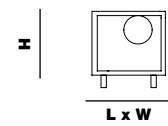

RHYTHM small lamp

L x W 27 x 12 cm | 10,63" x 4,72"
H 28 cm | 11,02"

1 G9 x max 7W - 220 Vdc

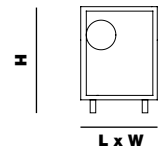

RHYTHM big lamp

L x W 23 x 12 cm | 9,06" x 4,72"
H 38 cm | 14,96"

1 G9 x max 7W - 220 Vdc

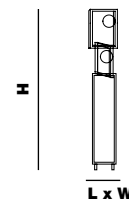

RHYTHM PT

L x W 23 x 27 cm | 9,06" x 10,63"
H 173 cm | 68,11"

2 G9 x max 7W - 220 Vdc

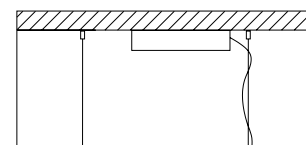

Altezza - Height
MIN 24 cm - 9.44"



Aggancio con rosone, tiranti e tasselli a soffitto; altezza regolabile (F) - Hook with ceiling cup, metal cables and ceiling cable gripper; adjustable height (F)

rhythm

Michele Losito

Particolari - Details

Sfere in pyrex con decorazione satinata. Strutture in metallo realizzate artigianalmente. La sospensione S8 è un esempio che indica la modularità: moltiplicando il modulo base S4 è possibile ottenere lunghezze e numero di luci differenti. Per qualsiasi richiesta o differente versione non esitate a contattarci.

Pyrex spheres with satin decoration. The metal structure is produced handmade. The suspension S8 is an example to indicate the modularity: by multiplying the base module S4 it's possible to obtain different lengths and different number of lights. Don't hesitate to contact us for any request or different version.

Metalli - Metals

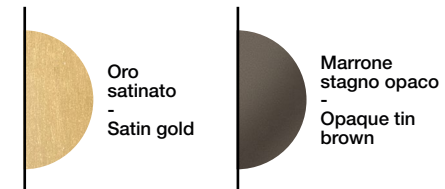

Vetro - Glass



Marrone Satinato
-
Satin brown

* Specifiche agganci - Info on hooks pag. 345 *

* Altre finiture e colori su richiesta - Other finishes and colors on request - see pag. 347-348 *

duo

*Sembrano campane libere nell'aria.
Un tenue cavetto ne sospende la luce che sgorga e si
diffonde dalla moltitudine dei colori delle belle calotte
leggere. Abbinamenti duali che riflettono la poliedricità della
personalità.*

STUDIO IN PROJECT

*They look like bells floating in the air.
A delicate cable suspends the light that flows out of them
and spreads from the multitude of colours of the beautiful
featherlight shades. Dual combinations that reflect the
versatility of the personality.*

STUDIO IN PROJECT



Duo S1 big | small





black & gold

lime green & black

dove gray & gold

copper & black

petrol green & gold

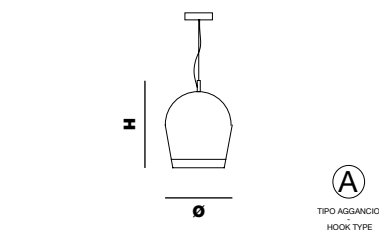

DUO big

Ø 30 cm | 11,81"
H 37 cm | 14,57"

1 bulb E27 x max 40W



TIPO AGGANCIO
HOOK TYPE

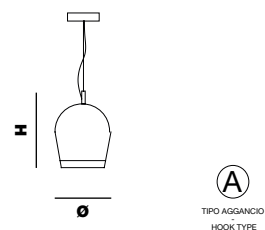

DUO small

Ø 20 cm | 7,87"
H 24 cm | 9,45"

1 bulb E27 x max 40W



TIPO AGGANCIO
HOOK TYPE

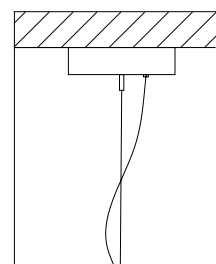

Altezza - Height
MIN 18 cm - 7.08"

Aggancio con rosone o scatola in metallo
e tirante in metallo; altezza regolabile (A)
- Hook with ceiling cup or metal box and
metal cable; adjustable height (A)

* Specifiche agganci - Info on hooks pag. 345 *

duo

Studio in Project

Particolari - Details

Strutture in alluminio stampato. Tecnica doppia colorazione realizzata artigianalmente da maestri decoratori. Per qualsiasi richiesta o differente versione non esitate a contattarci.

The structure is made of cast aluminum. Duo is decorated handmade by master craftsmen with the double decorative technique. Don't hesitate to contact us for any request or different version.

Metalli - Metals



* Altre finiture e colori su richiesta - Other finishes and colors on request - see pag. 347-348 *

nobody

Nobody è un'entità astratta, sostanza senza corpo: una sfera in metallo libera di essere orientata nello spazio. Soltanto un'esile ed eterea struttura la sostiene dal soffitto facendola galleggiare a mezz'aria. Nobody, "Nessuno", è anche un riferimento omerico, un omaggio all'astuzia di Ulisse che riuscì a sfuggire dalla grotta del gigante con un solo occhio Polifemo dicendo di chiamarsi Nessuno: il diffusore dell'apparecchio infatti può essere inteso come un singolo occhio da direzionare a piacere.

ALBERTO GHIRARDELLO

Nobody is an abstract entity, substance without body: a metal sphere free to move through space. Only a slender and ethereal structure supports it from the ceiling, making it float in mid-air. Nobody is also a Homeric reference, a tribute to the cunning of Ulysses who succeeded in escaping from the cave of the one-eyed giant Polyphemus by telling him his name was Nobody: the diffuser of the light fitting can be intended as a single eye to be positioned as desired.

ALBERTO GHIRARDELLO



Nobody S3

Nobody lamp small | big



Nobody big lamp





Nobody sphere





Nobody sphere





Nobody S3

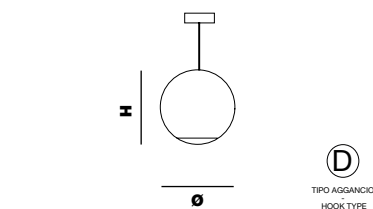

NOBODY sphere

ø 30 cm | 11,81"
H 30 cm | 11,81"

1 E27 bulb x max 40W - 220 Vdc

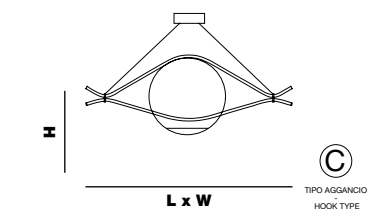

NOBODY S1

L x W 78 x 30 cm | 30,71" x 11,81"
H 30 cm | 11,81"

1 E27 bulb x max 40W - 220 Vdc

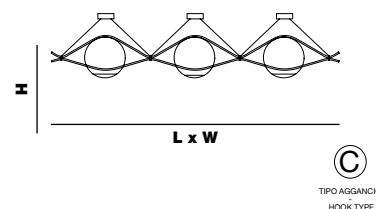

NOBODY S3

L x W 208 x 30 cm | 81,89" x 11,81"
H 31 cm | 12,20"

3 E27 bulb x max 40W - 220 Vdc

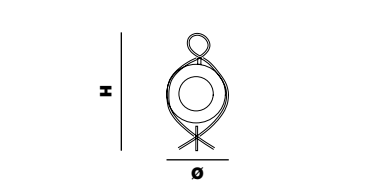

NOBODY small lamp

ø 20 cm | 7,87"
H 32 cm | 12,60"

1 E27 bulb x max 40W - 220 Vdc

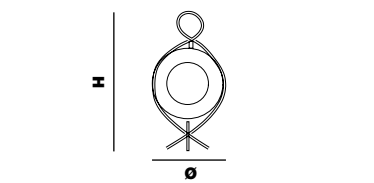

NOBODY big lamp

ø 30 cm | 11,81"
H 42 cm | 16,54"

1 E27 bulb x max 40W - 220 Vdc

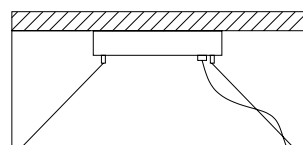

Altezza - Height
MIN 24 cm - 9.44"

(C) Aggancio con rosone o scatola e tiranti per sospensioni. Altezza regolabile (C)
Hook with ceiling cup or metal box and metal cables for suspension. Adjustable height (C)

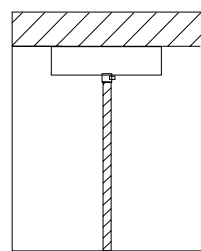

Altezza - Height
MIN 18 cm - 7.08"

(D) Aggancio con rosone o scatola a soffitto e cavo di alimentazione; altezza regolabile (D) - Hook with ceiling cup and power cord; adjustable height (D)

nobody

Alberto Ghirardello

Particolari - Details

Sfere in PMMA. Strutture in ferro realizzate artigianalmente. La sospensione S3 è un esempio: è possibile richiedere differente numero di elementi. Per qualsiasi richiesta o differente versione non esitate a contattarci.

Sphere in PMMA material. The iron structures are produced handmade. The suspension S3 is an example: it's possible to request different number of elements. Don't hesitate to contact us for any request or different version.

Metalli - Metals

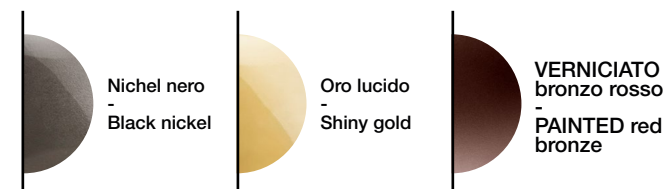

Plexiglass



* Specifiche agganci - Info on hooks pag. 345 *

* Altre finiture e colori su richiesta - Other finishes and colors on request - see pag. 347-348 *



gleam

*Un fascio di luce, un bagliore che attraversa la perfezione del
cristallo riversando lo splendore dei riflessi tutt'intorno.
Seducante splendore che incanta.*

STUDIO IN PROJECT

*A beam of light, a glimmer that penetrates the perfection
of the crystal, casting the splendour of the reflections all
around. Seductive and enchanting radiance.*

STUDIO IN PROJECT



Gleam 2



Gleam wall



Gleam lamp



Gleam 1



Gleam floor lamp



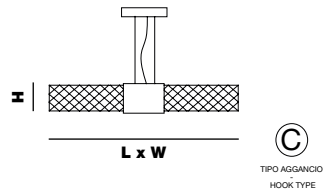

GLEAM 2

L x W 70 x 10 cm | 27,56" x 3,94"
H 10 cm | 3,94"

2 spot led 6W - 4000°K - 12 Vdc - 560 lm
 life time 30.000 hrs - SMD type 5630 - Dimmable: yes

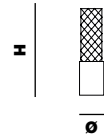

GLEAM lamp

Ø 10 cm | 3,94"
H 26 cm | 10,24"

2 spot led 3W - 4000°K - 12 Vdc - 280 lm
 life time 30.000 hrs - SMD type 5630 - Dimmable: yes

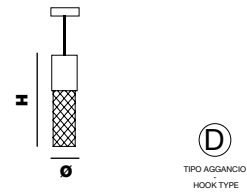

GLEAM 1

Ø 10 cm | 3,94"
H 26 cm | 10,24"

1 spot led 3W - 4000°K - 12 Vdc - 280 lm
 life time 30.000 hrs - SMD type 5630 - Dimmable: yes

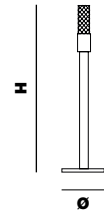

GLEAM floor lamp

Ø 32 cm | 12,60"
H 165 cm | 64,96"

1 spot led 3W - 4000°K - 12 Vdc - 280 lm
 life time 30.000 hrs - SMD type 5630 - Dimmable: yes

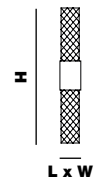

GLEAM wall

L x W 10 x 14 cm | 3,94" x 5,51"
H 55 cm | 21,65"

1 spot led 6W - 4000°K - 12 Vdc - 560 lm
 life time 30.000 hrs - SMD type 5630 - Dimmable: yes

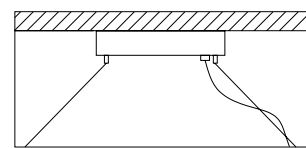

Altezza - Height
 MIN 24 cm - 9,44"

C Aggancio con rosone o scatola e tiranti per sospensioni. Altezza regolabile (C)
 Hook with ceiling cup or metal box and metal cables for suspension. Adjustable height (C)

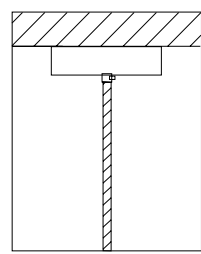

Altezza - Height
 MIN 18 cm - 7,08"

D Aggancio con rosone o scatola a soffitto e cavo di alimentazione; altezza regolabile (D) - Hook with ceiling cup and power cord; adjustable height (D)

gleam

Studio in Project

Particolari - Details

Strutture realizzate artigianalmente su nostro disegno. Cristallo molato made in Toscana. Per qualsiasi richiesta o differente versione non esitate a contattarci.

Metal structures are produced handmade on our drawing. Polished crystal made in Tuscany. Don't hesitate to contact us for any request or different version.

Metalli - Metals

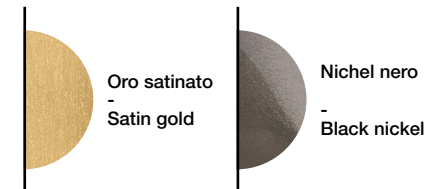

Vetro - Glass

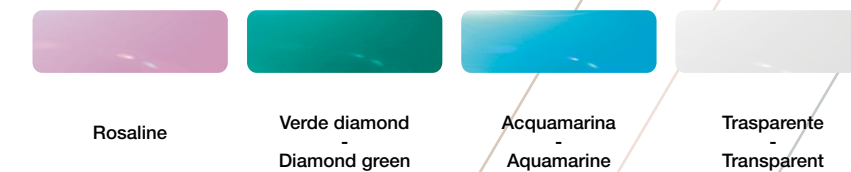

* Specifiche agganci - Info on hooks pag. 345 *

* Altre finiture e colori su richiesta - Other finishes and colors on request - see pag. 347-348 *



mikado

Un intreccio di elementi, un groviglio che pian piano, con la giusta attenzione precisione e meditazione si dispiega.

NUNZIA ACQUAVIVA

A jumble of elements, a tangle which, thanks to just the right amount of attention, precision and meditation, slowly unravels.

NUNZIA ACQUAVIVA

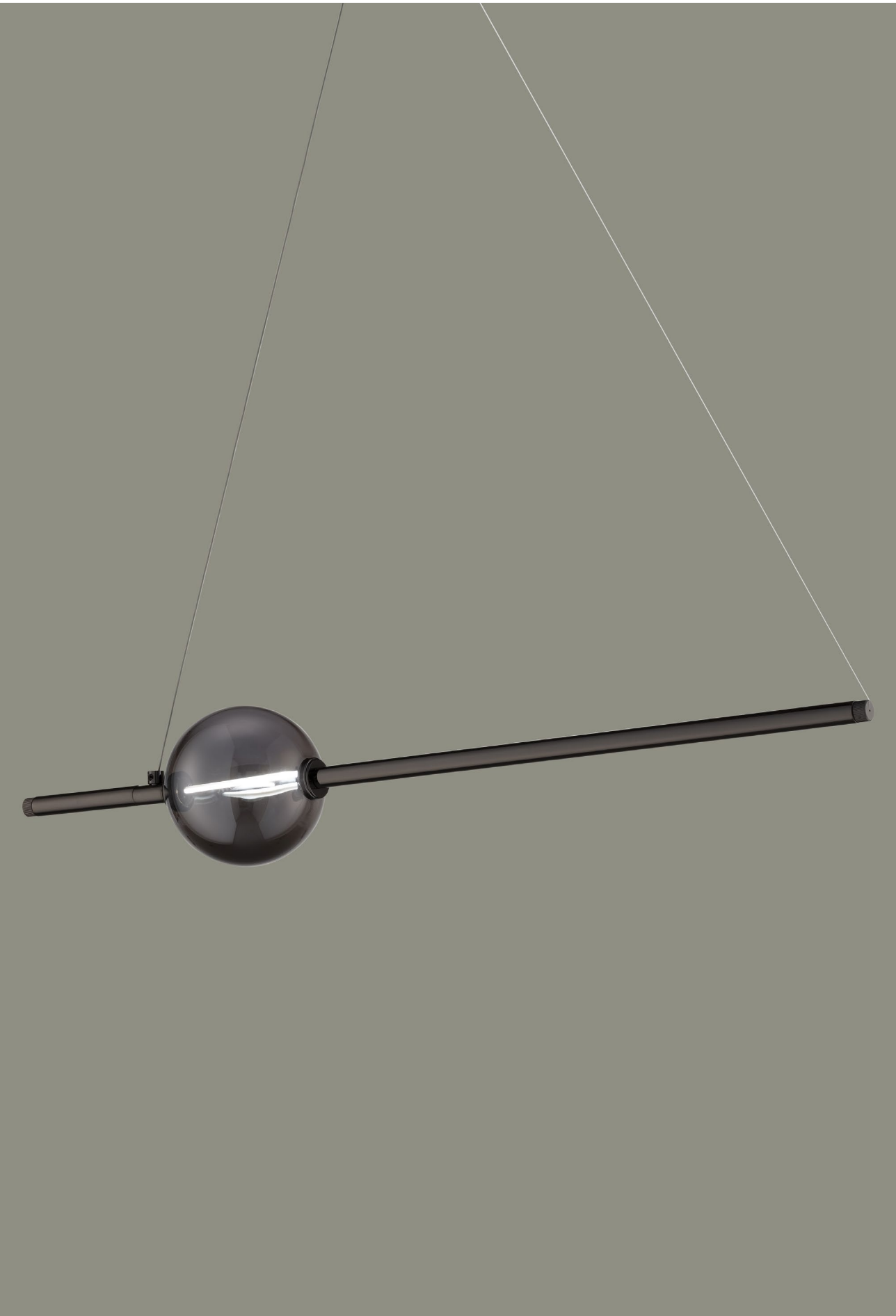

Mikado horizon



Mikado in & out

Mikado S3

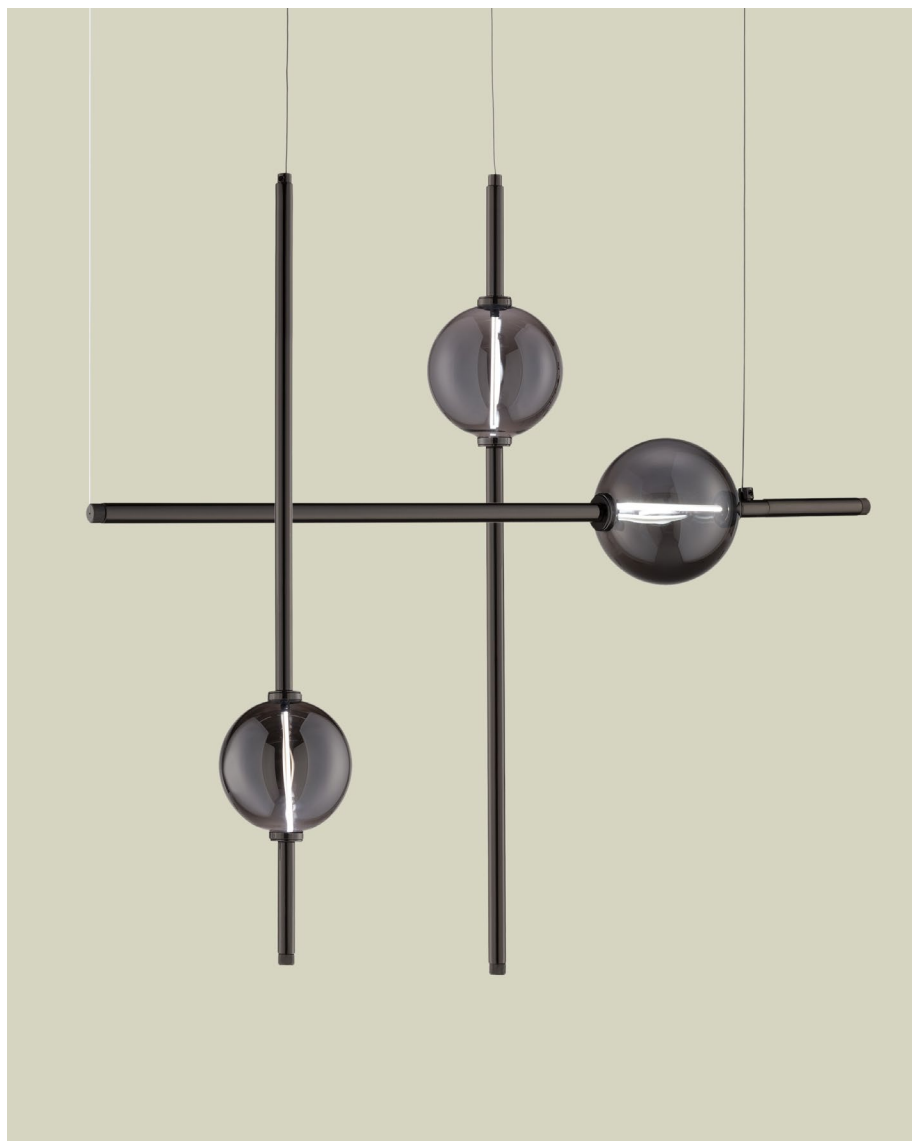

Mikado S12

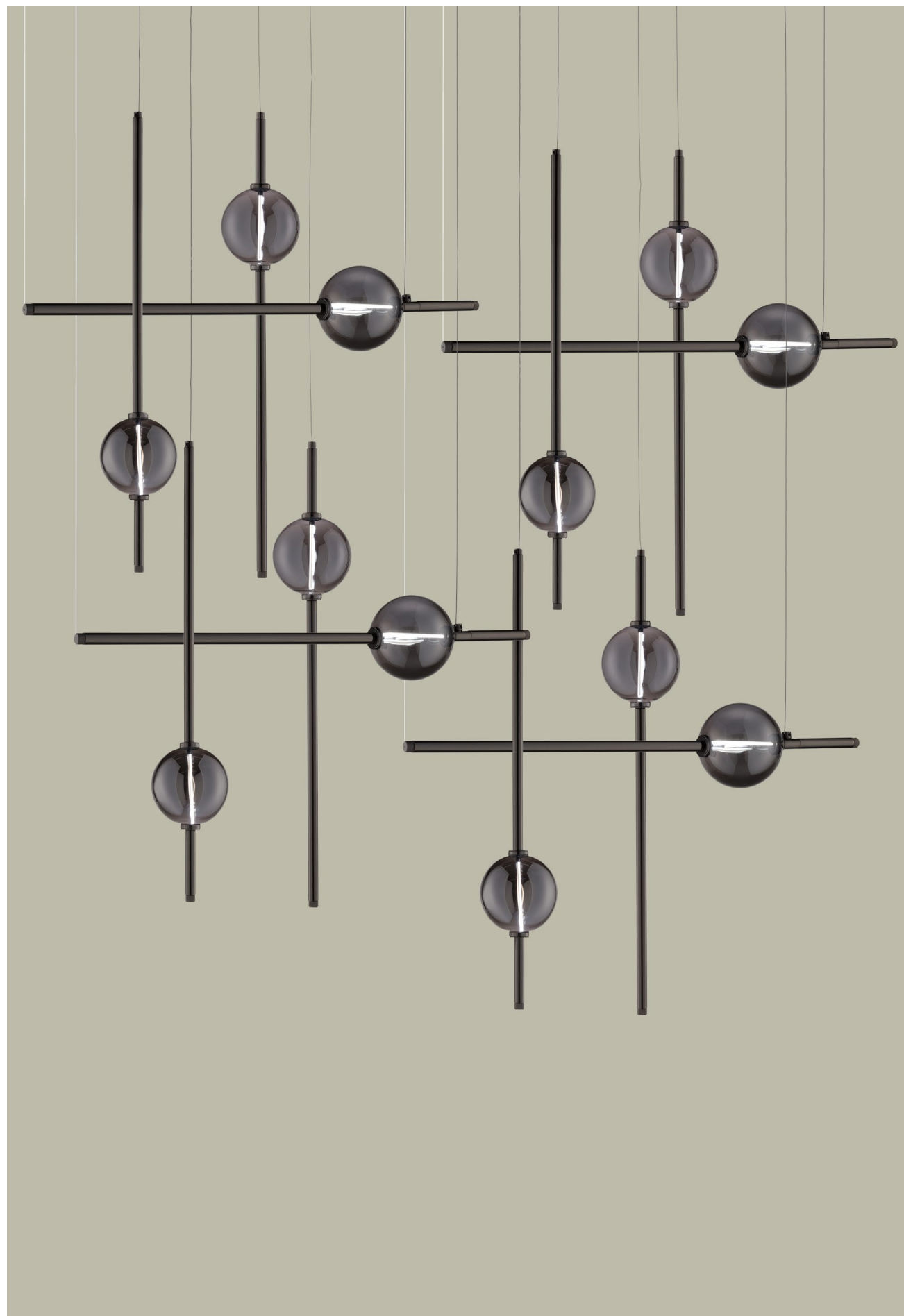



Mikado S12

Mikado wall lamp 3

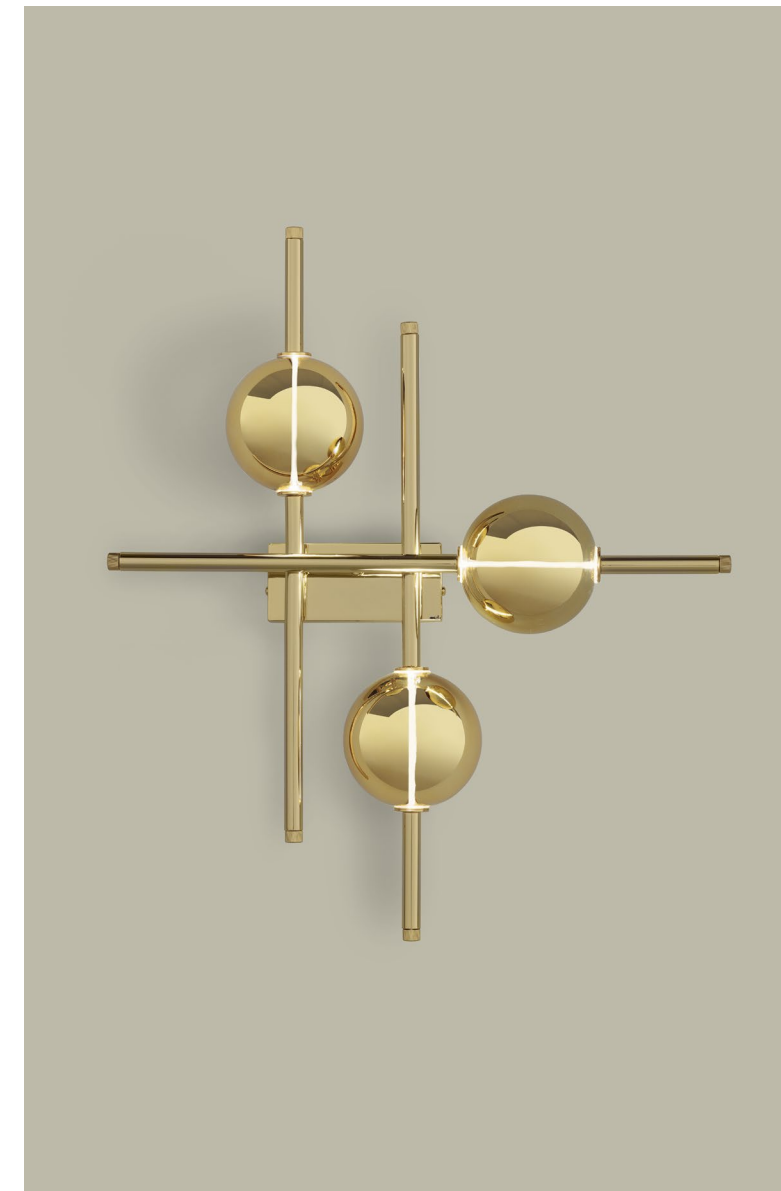



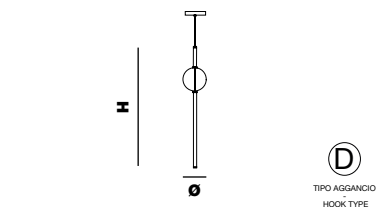

MIKADO in
 Ø 12 cm | 4,72"
 H 70 cm | 27,56"

1 tinylight 2W - 3500°K - 24 Vdc - 300 lm
 life time 20.000 hrs - SMD type fil - Dimmable: yes

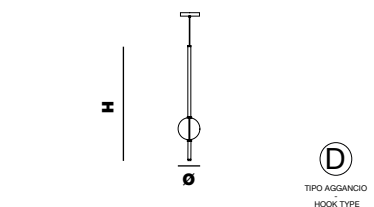

MIKADO out
 Ø 12 cm | 4,72"
 H 70 cm | 27,56"

1 tinylight 2W - 3500°K - 24 Vdc - 300 lm
 life time 20.000 hrs - SMD type fil - Dimmable: yes

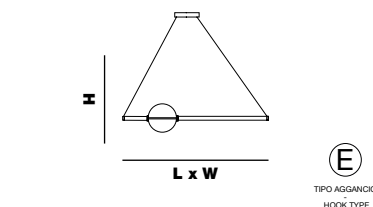

MIKADO horizon
 L x W 70 x 12 cm | 27,56" x 4,72"
 H 12 cm | 4,72"

1 tinylight 2W - 3500°K - 24 Vdc - 300 lm
 life time 20.000 hrs - SMD type fil - Dimmable: yes

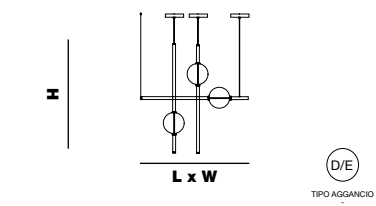

MIKADO S3
 L x W 70 x 34 cm | 27,56" x 13,39"
 H 70 cm | 27,56"

3 tinylight 6W - 3500°K - 24 Vdc - 900 lm
 life time 20.000 hrs - SMD type fil - Dimmable: yes

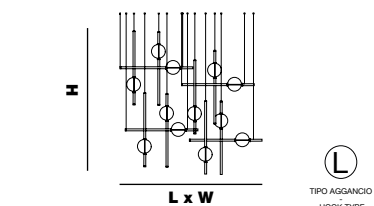

MIKADO S12
 L x W 148 x 84 cm | 58,27" x 33,07"
 H 149 cm | 58,66"

12 tinylight 24W - 3500°K - 24 Vdc - 7200 lm
 life time 20.000 hrs - SMD type fil - Dimmable: yes

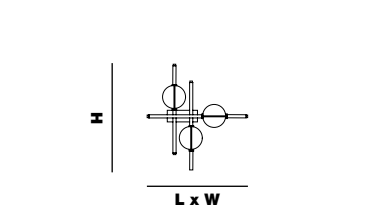

MIKADO wall lamp 3
 L x W 54 x 17 cm | 21,26" x 6,69"
 H 64 cm | 25,20"

3 tinylight 6W - 3500°K - 24 Vdc - 900 lm
 life time 20.000 hrs - SMD type fil - Dimmable: yes

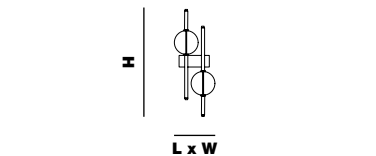

MIKADO wall 2
 L x W 16 x 14 cm | 6,30" x 5,51"
 H 64 cm | 25,20"

2 tinylight 4W - 3500°K - 24 Vdc - 600 lm
 life time 20.000 hrs - SMD type fil - Dimmable: yes

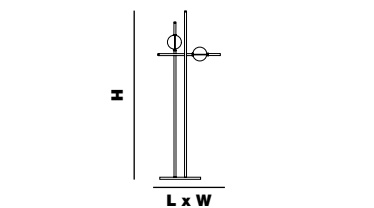

MIKADO PT
 L x W 45 x 30 cm | 17,72" x 11,81"
 H 171 cm | 67,32"

2 tinylight 4W - 3500°K - 24 Vdc - 600 lm
 life time 20.000 hrs - SMD type fil - Dimmable: yes

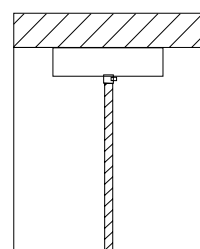

Altezza - Height
 MIN 18 cm - 7.08"

D Aggancio con rosone o scatola a soffitto e cavo di alimentazione; altezza regolabile (D) - Hook with ceiling cup and power cord; adjustable height (D)

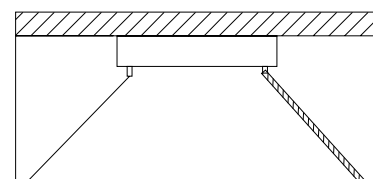

Altezza - Height
 MIN 24 cm - 9.44"

E Aggancio con rosone, tirante e cavo di alimentazione per sospensioni; altezza regolabile (E) - Hook with ceiling cup, metal cables and power cord for suspension; adjustable height (E)

L Aggancio da definire (L) - Hooks to be defined (L)

mikado

Nunzia Acquaviva

Particolari - Details

Sfere in pyrex con decorazione metallizzata che consente di nascondere la fonte luminosa quando la sospensione è spenta. Accesa la sospensione mostra all'interno un filamento led. La sospensione S12 è un esempio: è possibile richiedere differenti configurazioni, forme e numero di elementi. Per qualsiasi richiesta o differente versione non esitate a contattarci.

Pyrex spheres with metallic decoration: when the suspension is off the light source cannot be seen; when the suspension is on, the led filament can be seen. The suspension S12 is an example: it's possible to request different configurations, shapes and number of elements. Don't hesitate to contact us for any request or different version.

Vetro - Glass

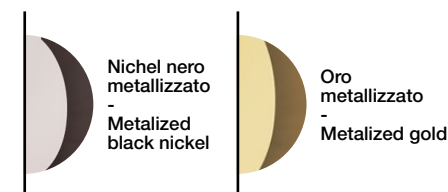

Metalli - Metals

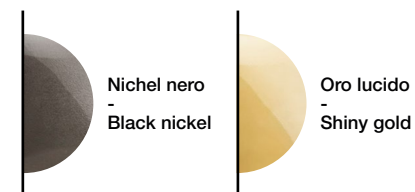

* Specifiche agganci - Info on hooks pag. 345 *

* Altre finiture e colori su richiesta - Other finishes and colors on request - see pag. 347-348 *

The background features a complex, abstract geometric pattern of bright blue lines and circles on a dark blue background. The pattern consists of a central point from which multiple lines radiate outwards, connecting to various sized circles. Some lines are straight, while others are curved, creating a sense of movement and depth. The overall effect is that of a network or a series of interconnected points and paths.

vector

Figure geometriche che si rincorrono, segmenti di metallo si librano nelle tre dimensioni dello spazio, spigoli, direzioni che assume la quotidianità.

NUNZIA ACQUAVIVA

Geometrical figures that chase each other, metal segments that hover in the three dimensions of space, and the edges formed and directions taken by everyday life.

NUNZIA ACQUAVIVA





Vector project

Vector 30 | Vector 10



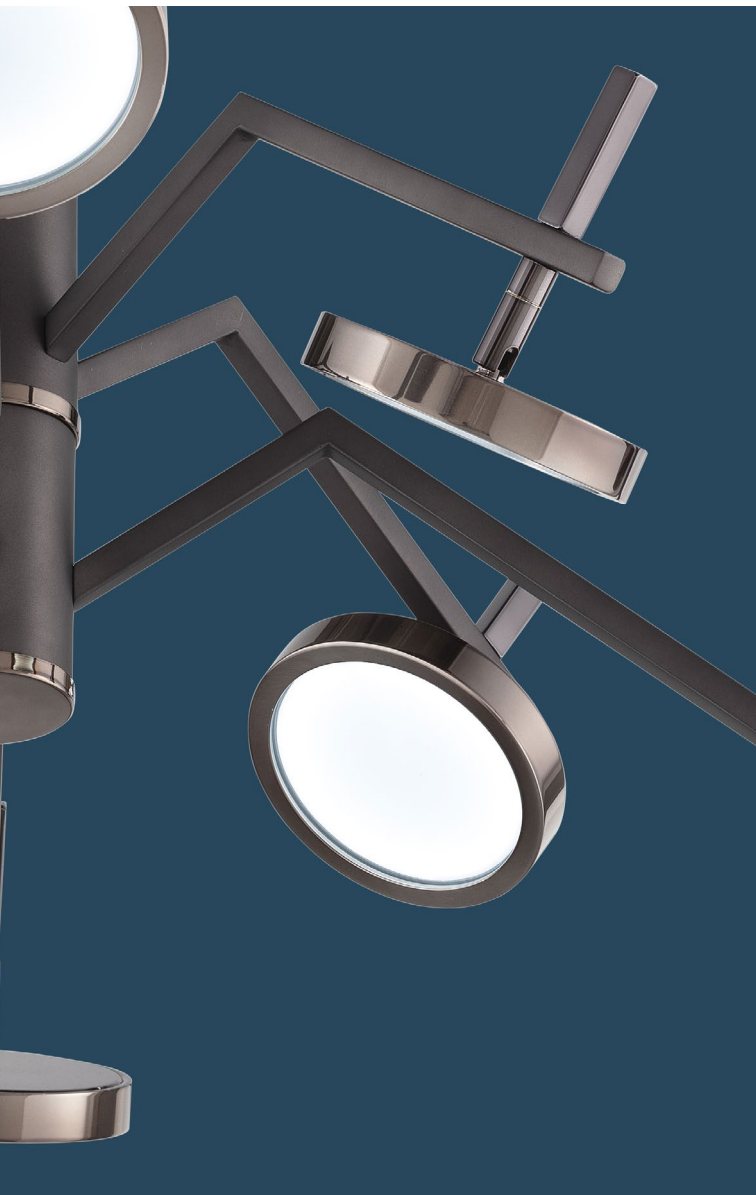

Vector lamp



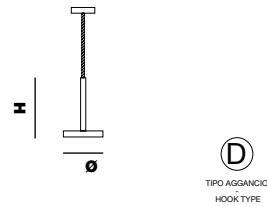

VECTOR 10

Ø 11 cm | 4,33"
H 17 cm | 6,69"

1 strip led 6W - 4000°K - 24 Vdc - 565 lm
life time 30.000 hrs - SMD type 2835 - Dimmable: yes

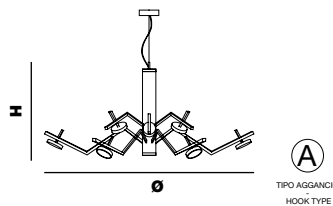

VECTOR 6+6

Ø 115 cm | 45,28"
H 42 cm | 16,54"

12 strip led 72W - 4000°K - 24 Vdc - 6780 lm
life time 30.000 hrs - SMD type 2835 - Dimmable: yes

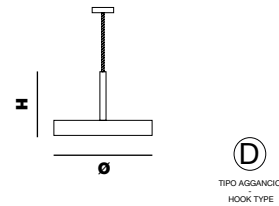

VECTOR 30

Ø 30 cm | 11,81"
H 25 cm | 9,84"

1 strip led 40W - 4000°K - 24 Vdc - 3392 lm - life time
30.000 hrs - SMD type 2835 - Dimmable: yes

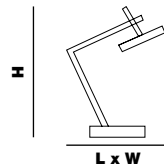

VECTOR lamp

L x W 28 x 16 cm | 11,02" x 6,30"
H 36 cm | 14,17"

1 strip led 6W - 4000°K - 24 Vdc - 565 lm
life time 30.000 hrs - SMD type 2835 - Dimmable: yes

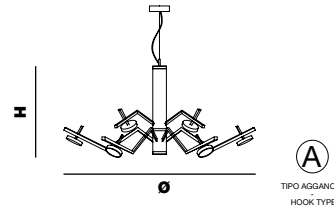

VECTOR 4+4

Ø 93 cm | 36,61"
H 40 cm | 15,75"

8 strip led 48W - 4000°K - 24 Vdc - 4520 lm - life time
30.000 hrs - SMD type 2835 - Dimmable: yes

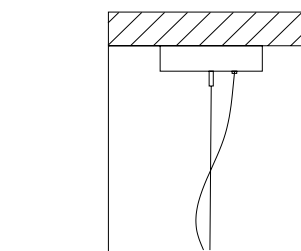

Altezza - Height
MIN 18 cm - 7,08"

A Aggancio con rosone o scatola in metallo e tirante in metallo; altezza regolabile (A) - Hook with ceiling cup or metal box and metal cable; adjustable height (A)

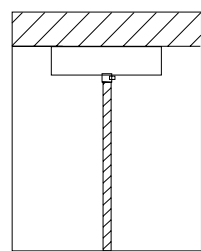

Altezza - Height
MIN 18 cm - 7,08"

D Aggancio con rosone o scatola a soffitto e cavo di alimentazione; altezza regolabile (D) - Hook with ceiling cup and power cord; adjustable height (D)

vector

Nunzia Acquaviva

Particolari - Details

Strutture realizzate artigianalmente su nostro disegno.
Per qualsiasi richiesta o differente versione non esitate a contattarci.

Metal structures are produced handmade on our drawing.
Don't hesitate to contact us for any request or different version.

Metalli - Metals

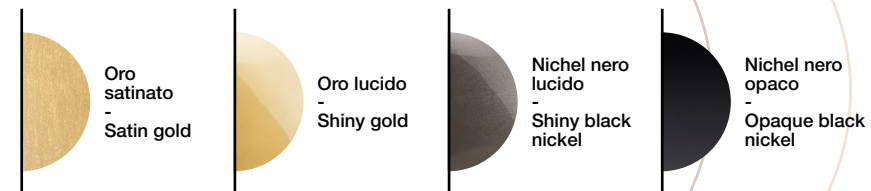

Vetro - Glass

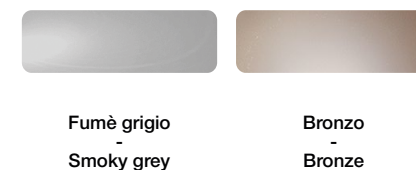

* Specifiche agganci - Info on hooks pag. 345 *

* Altre finiture e colori su richiesta - Other finishes and colors on request - see pag. 347-348 *

effect

*Il disordine dell'universo è apparente.
Il disordine degli elementi si compone in sublime armonia.
È l'incanto e la magnificenza della creazione.*

MICHELE LOSITO

*The disorder of the universe is apparent.
The disorder of the elements comes together in sublime
harmony. The enchantment and magnificence of creation.*

MICHELE LOSITO



Effect L14



Effect A2

Effect L14

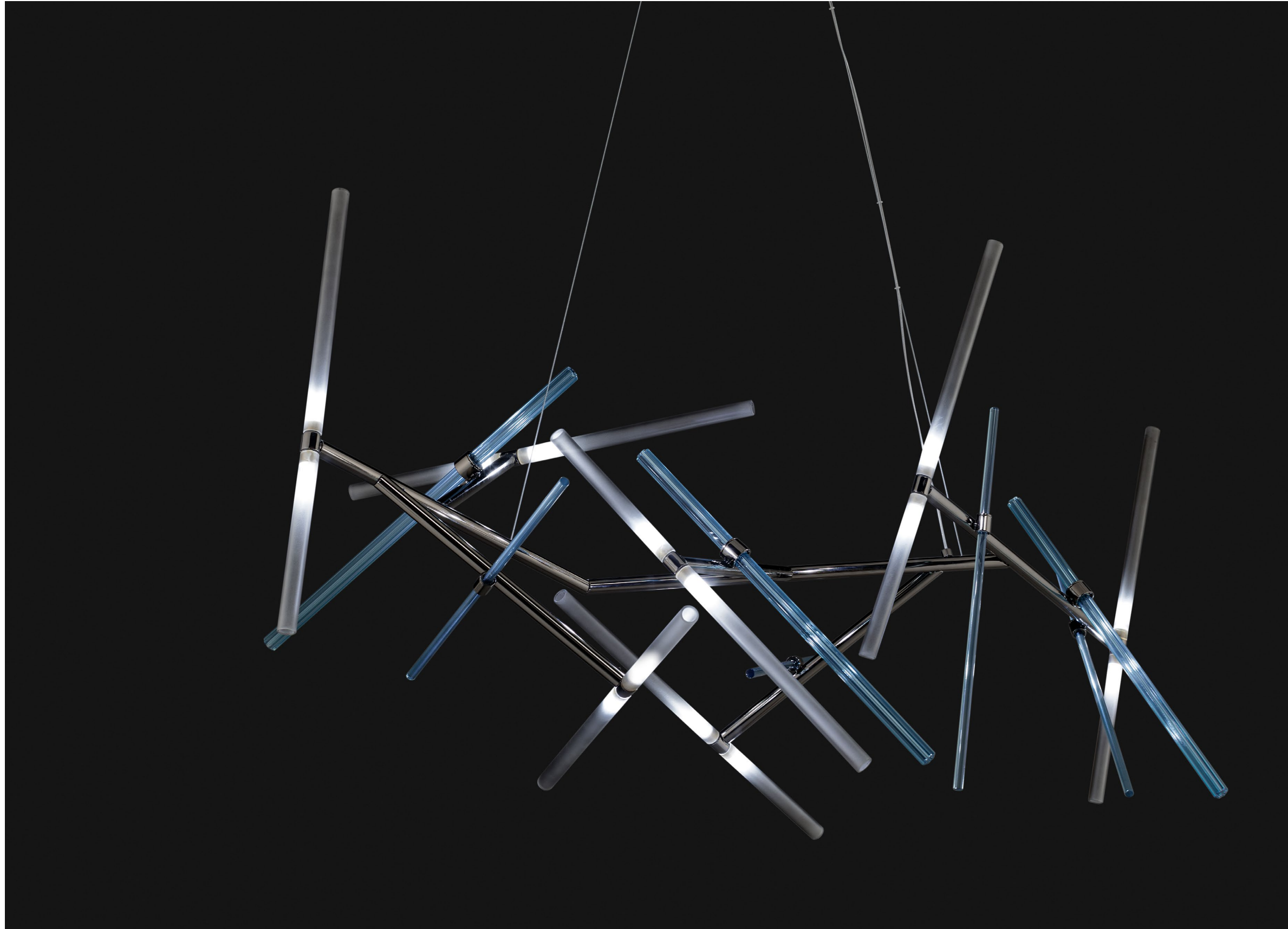

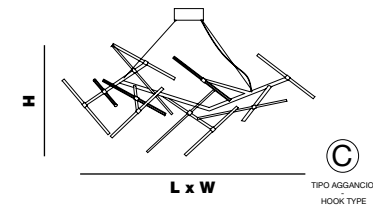

EFFECT L14

L x W 140 x 66 cm | 55,12" x 25,98"
H 70 cm | 27,56"

14 bulb G4 28W - 2700°K - 12 Vdc - 2800 lm
 life time 25.000 hrs - SMD type 550 - Dimmable: no

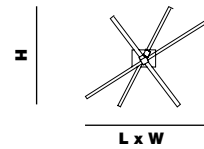

EFFECT A2 wall lamp

L x W 40 x 20 cm | 15,75" x 7,87"
H 20 cm | 7,87"

2 bulb G4 4W - 2700°K - 12 Vdc - 400 lm
 life time 25.000 hrs - SMD type 550 - Dimmable: no

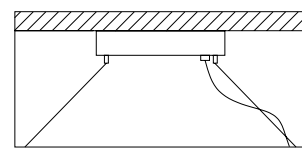

Altezza - Height
 MIN 24 cm - 9.44"

C Aggancio con rosone o scatola e tiranti per sospensioni. Altezza regolabile (C)
 Hook with ceiling cup or metal box and metal cables for suspension. Adjustable height (C)

effect

Michele Losito

Particolari - Details

Struttura in ferro realizzata artigianalmente. Boccole in ottone tornito. Effect è composto da tubi porta luce in borosilicato, tubi stella in borosilicato e tubi pieni in vetro di murano

The metal structure is produced handmade. Brass bushes. Effect has borosilicate bulb holder tubes, borosilicate tubes with stars section and full Murano glass tubes. Don't hesitate to contact us for any request or different version.

Metalli - Metals

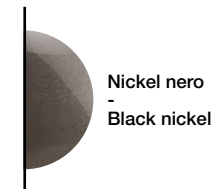

Vetro - Glass

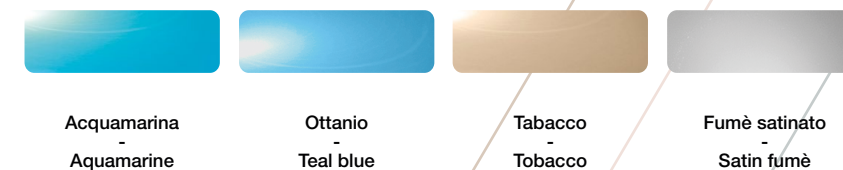

* Specifiche agganci - Info on hooks pag. 345 *

* Altre finiture e colori su richiesta - Other finishes and colors on request - see pag. 347-348 *



agganci - hooks

N.B.:

Per le dimensioni dei rosoni e altre specifiche non esitate a contattarci. Se non diversamente richiesto dal cliente, i nostri prodotti vengono forniti con aggancio altezza 150 cm per le tipologie A-D-E-F; con aggancio altezza 70 cm per tipologia B; con aggancio altezza 100 cm per tipologia C; con aggancio altezza 110 cm per tipologia G.

For ceiling cup sizes and other specifications don't hesitate to contact us. Unless otherwise requested by the customer, our products are supplied with 150 cm height hook for types A-D-E-F; with 70 cm height hook for type B; with 100 cm height hook for type C; with 110 cm height hook for type G.



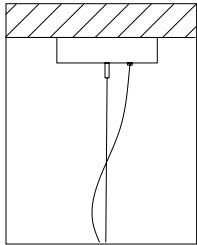
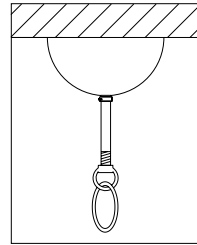
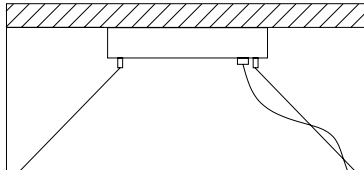
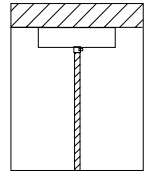
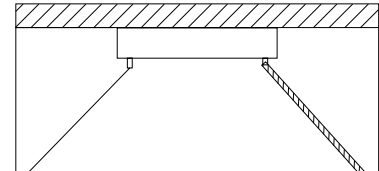
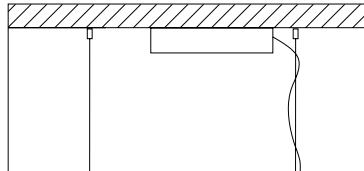
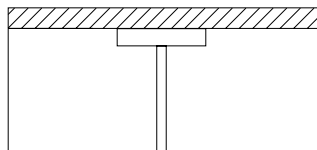
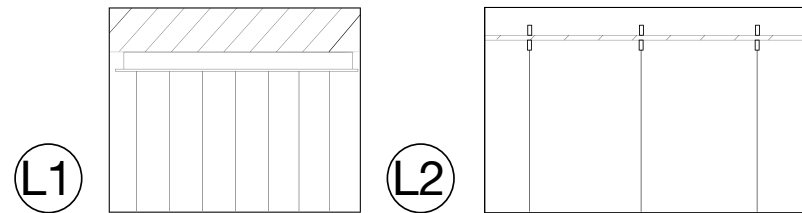







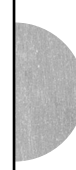

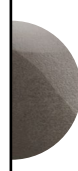



*** per informazioni specifiche riferirsi alle sezioni relative ai singoli prodotti.**
*** for specific information refer to individual product sections.**

 <p>Altezza - Height MIN 18 cm - 7.08"</p> <p>A Aggancio con tirante in metallo (A) Hook with metal cable (A)</p> <p>L'altezza dei lampadari è calcolata escludendo l'aggancio. Aggancio con rosone o scatola e filo tirante.</p> <p>The height of the chandeliers is calculated by excluding the hook. Hook with the ceiling cup or metal box and cable.</p>	 <p>Altezza - Height MIN 24 cm - 9.44"</p> <p>B Aggancio con catena (B) Hook with chain (B)</p> <p>L'altezza dei lampadari è calcolata escludendo l'aggancio. Aggancio con rosone e catena.</p> <p>The height of the chandeliers is calculated by excluding the hook. Hook with the ceiling cup and chain.</p>	 <p>Altezza - Height MIN 24 cm - 9.44"</p> <p>C Aggancio con tiranti per sospensioni (C) - Hook with metal cables for suspension (C)</p> <p>L'altezza delle sospensioni è calcolata escludendo l'aggancio. Aggancio con rosone o scatola e tiranti.</p> <p>The height of suspensions is calculated by excluding the hook. Hook with the ceiling cup or metal box and metal cables.</p>
 <p>Altezza - Height MIN 24 cm - 9.44"</p> <p>D Aggancio con cavo di alimentazione (D) Hook with power cord (D)</p> <p>L'altezza dei lampadari è calcolata escludendo l'aggancio. Aggancio con rosone o scatola a soffitto e cavo di alimentazione.</p> <p>The height of the chandeliers is calculated by excluding the hook. Hook with the ceiling cup and power cord.</p>	 <p>Altezza - Height MIN 24 cm - 9.44"</p> <p>E Aggancio con tirante e cavo di alimentazione per sospensioni (E) Hook with metal cables and power cord for suspension (E)</p> <p>L'altezza delle sospensioni è calcolata escludendo l'aggancio. Aggancio con rosone, tirante e cavo di alimentazione.</p> <p>The height of suspensions is calculated by excluding the hook. Hook with the ceiling cup, metal cable and power cord.</p>	 <p>Altezza - Height MIN 24 cm - 9.44"</p> <p>F Aggancio con tiranti e tasselli a soffitto (F) - Hook with metal cables and ceiling cable gripper (F)</p> <p>L'altezza delle sospensioni è calcolata escludendo l'aggancio. Aggancio con rosone e tiranti con tasselli a soffitto.</p> <p>The height of suspensions is calculated by excluding the hook. Hook with the ceiling cup and metal cables with ceiling cable gripper.</p>
 <p>Altezza - Height MIN 15 cm - 5.91"</p> <p>G Aggancio altezza fissa (G) Hook with fixed height (G)</p> <p>L'altezza delle sospensioni è calcolata escludendo l'aggancio. Aggancio con rosone e aste cilindriche fisse.</p> <p>The height of the suspension is calculated excluding the hook. Hook with ceiling cup and cylindrical rods.</p>	 <p>L1 L2</p> <p>L Aggancio da definire (L) - Hooks to be defined (L)</p> <p>*L'altezza dei lampadari e il relativo prezzo è calcolata escludendo l'aggancio. Per le proposte progettuali è possibile richiedere</p> <p>Aggancio L1 : scatola in metallo H MIN 5 cm o in legno H MIN 10 cm, decorati o successivamente verniciabili da ancorare al soffitto con staffa .</p> <p>Aggancio L2 : senza scatola; gli elementi prevedono agganci singoli a soffitto. Si richiede la presenza di soffitto in cartongesso.</p> <p>*The height of the chandeliers and their price is calculated excluding the hook. For project proposals it is possible to request</p> <p>Hook L1 : metal box H MIN 5 cm or wood H MIN 10 cm, decorated or subsequently paintable to be anchored to the ceiling with bracket .</p> <p>Hook L2 : without box; the elements provide individual ceiling hooks. It requires the presence of plasterboard ceiling.</p>	

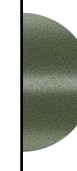
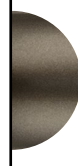

**finiture
-
finishes**

Finiture metalli - Metal Finishes

 Cromo lucido - Shiny chrome	 Cromo satinato - Satin chrome	 Oro lucido - Shiny gold	 Oro satinato - Satin gold
 Nichel nero - Black nickel	 Marrone stagno opaco - Matt tin brown		 VERNICIATO Brunito antico spazzolato - PAINTED Burnished antique brushed
 VERNICIATO oro champagne - PAINTED champagne gold	 VERNICIATO oro satinato - PAINTED satin gold	 VERNICIATO bronz rosso - PAINTED red bronze	 VERNICIATO Rame - PAINTED Copper
	 RAL 9005 nero opaco - opaque black	 RAL 9010 bianco - white	 RAL 2010 Arancio segnale - Signal orange
 RAL 3012 Rosso beige - Beige red	 RAL 5021 Ottanio liquido - Teal Blue	 RAL 8238 Blu metallizzato - Metallic Blue	 RAL 6003 Verde Oliva - Olive green
 RAL 8011 Marrone metallizzato - Metallic brown	 RAL 441 cedro - lime green	 RAL 1019 Beige grigiastro - Grey beige	

Finiture vetri - Glass Finishes



Trasparente
Transparent



Trasparente satinato
Satin transparent



Fumè grigio
Grey fumè



Fumè satinato
Satin fumè



Verde diamond
Diamond green



Rosaline



Acquamarina
Aquamarine



Acquamarina satinato
Satin aquamarine



Ambra
Amber



Topazio
Topaz



Viridian



Viridian satinato
Satin viridian



Tabacco
Tobacco

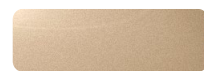

Tabacco satinato
Satin tobacco



Ottanio
Teal blue



Ottanio satinato
Satin teal blue



Marrone satinato
Satin brown



Violet

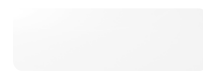

Bianco opalino
Opaline white



Nichel nero metallizzato
Metallic black nichel



Oro lucido metallizzato
Metallic shiny gold

Vetro marmorizzato - Marbled glass



Tan grey



Calacatta electric silver



Calacatta natural



Quarzite brown

Marmo - Marble



Amazing gray



Forest green



Marquinia black



Mystic brown



Royal Daino beige



Spider white

Euroluce Lampadari non risponde per eventuali danni a persone o cose causati da una non corretta installazione dei propri apparecchi di illuminazione, da un uso di lampadine non conformi e dalla modificazione delle caratteristiche tecnico costruttive.

Il marchio CE è un marchio europeo di garanzia che certifica la qualità del prodotto e la sua rispondenza ai parametri di sicurezza previsti dalle normative CEE.

Euroluce Lampadari può fornire per la quasi totalità dei suoi articoli la certificazione con marchio UL. Questo catalogo è tutelato dalla legge sui diritti d'autore (legge 22/4/1941 n°633 e dalla legge 14/12/1942 n°1485). È vietata ogni riproduzione anche parziale dello stesso.

Euroluce Lampadari is not liable for incidental injuries or damage to people or things due to: incorrect installation of the fixtures, use of not suitable bulbs, modification of the original technical features of the items.

The label CE is a European guaranteed mark. It certifies product quality and its compliance with the safety standards stated by EEC regulations.

Euroluce Lampadari can provide for most of its products the UL certification.

This catalogue is copyrighted and protected by the Italian law (22/4/1941 n°633 and 14/12/1942 n°1485). Any reproduction of this catalogue is strictly forbidden.

LUMEN

Flusso luminoso nominale. L'indicazione si riferisce al valore in assenza di rifrazione, come dichiarato dal produttore del componente.

Nominal luminous flux. It refers to the value without any refraction, as declared by the component manufacturer.

ART DIRECTION / STYLING

Studio in Project

PHOTO

Francesco Stragapede

Le capacità delle tecniche di stampa non permettono una riproduzione assolutamente fedele delle variazioni cromatiche. Pertanto, si prega di considerare le tonalità di colore come indicazioni approssimative. Allo stesso modo, le illustrazioni e le descrizioni fornite sono da interpretare in modo approssimativo. L'azienda si riserva il diritto di apportare modifiche in qualsiasi momento, senza preavviso, al fine di soddisfare le esigenze legate alla produzione e al mercato.

The capabilities of printing techniques do not allow for an absolutely faithful reproduction of color variations. Therefore, please consider the color tones as approximate indications. Similarly, the provided illustrations and descriptions should be interpreted in an approximate manner. The company reserves the right to make changes at any time, without prior notice, in order to meet the requirements related to production and the market.

euroluce
— LIGHT OF ITALY —

76123 Andria (BT) Italy +39 0883 559385 www.eurolucelampadari.it | info@eurolucelampadari.it | export@eurolucelampadari.it

