



**NEWNOW**

2025

Pricelist

**euroluce**  
— LIGHT OF ITALY —

**TXXNTY**

euroluce  
— LIGHT OF ITALY —

# Indice - Index

Dewy	4
Dopamine	6
Theorem	8
Pegaso	10
Nido	12
Henos	14

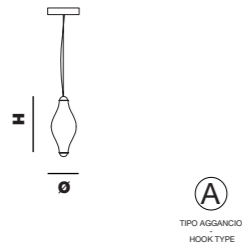

**DEWY S1**

Ø 12 cm | 4,72"  
H 30 cm | 11,81"

1 - 360° neon flex 4,32W - 3000°K - 24 Vdc -  
240 lm - Dimmable: yes

€ 424,00

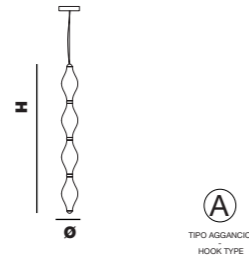

**DEWY S4**

Ø 12 cm | 4,72"  
H 120 cm | 47,24"

1 - 360° neon flex 17,30 W - 3000°K - 24 Vdc -  
360 lm - Dimmable: yes

€ 1.620,00

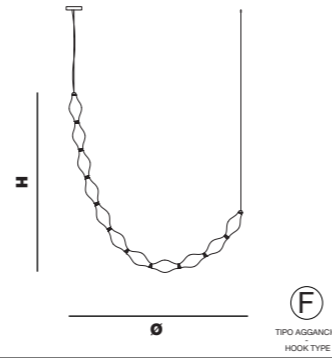

**DEWY S11**

Ø 12 cm | 4,72"  
H 350 cm | 137,79"

1 - 360° neon flex 51 W - 3000°K - 24 Vdc -  
2800 lm - Dimmable: yes

€ 4.420,00

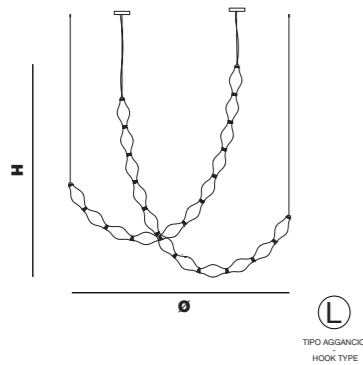

**DEWY S11+S11**

**Customisable configuration**

2 - 360° neon flex 102 W - 3000°K - 24 Vdc -  
5600 lm - Dimmable: yes

€ 8.840,00

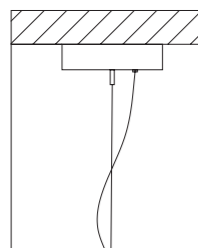

Altezza - Height  
MIN 18 cm - 7,08"



Aggancio con tirante in metallo (A)  
Hook with metal cable (A)

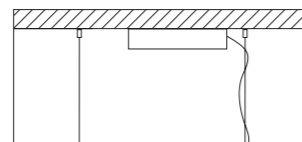

Altezza - Height  
MIN 24 cm - 9,44"



Aggancio con rosone, tiranti e tasselli  
a soffitto; altezza regolabile (F) - Hook  
with ceiling cup, metal cables and ceiling  
cable gripper; adjustable height (F)



Aggancio da definire (L) - Hooks to be defined (L)  
prezzo senza scatola - price without box

# Dewy

Alberto Ghirardello

## Particolari - Details

Collezione progettuale e personalizzabile nelle lunghezze. I vetri in borosilicato sono made in Veneto e sono successivamente decorati per creare luce diffusa e armoniosa. Le boccole di congiunzione sono in alluminio tornito e fresato su disegno. La loro forma tondeggiante consente il movimento della collana Dewy e permette di poterla adattare nelle curve e forme.

All'interno un neonflex 360° percorre l'intera collana senza interruzioni di luce.  
Possibilità di scegliere 3000 k / 4000 k

A design collection that can be customised in lengths. The borosilicate glass panes are made in Veneto and are subsequently decorated to create diffuse and harmonious light. The joint bushings are made of turned and milled aluminium according to design. Their rounded shape allows the Dewy necklace to move and can be adapted in curves and shapes.

Inside, a 360° neonflex runs through the entire necklace without interruption of light.  
Choice of 3000 k / 4000 k

## Metalli - Metals



Oro lucido  
Shiny gold

## Color



Bianco latte  
Milk white

\* Specifiche agganci - Info on hooks pag. 16-17 \*

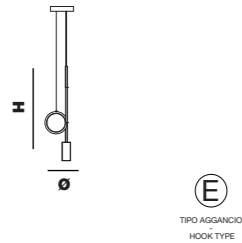

**DOPAMINE S1**

ø 17 cm | 6,69"  
H 62 cm | 24,40"

1 GU10 PAR 16 bulb x max 4W - 3000°K - 220 Vdc

€ 524,00

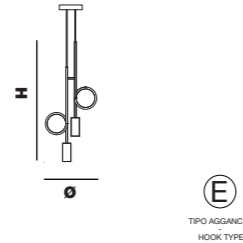

**DOPAMINE S2**

ø 35 cm | 13,77"  
H 80 cm | 31,49"

2 GU10 PAR 16 bulb x max 4W - 3000°K - 220 Vdc  
Dimmable: no

€ 924,00

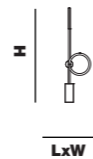

**DOPAMINE WALL LAMP**

LxW 17x11 cm | 6,69 x 4,33"  
H 62 cm | 24,40"

1 GU10 PAR 16 bulb x max 4W - 3000°K - 220 Vdc  
Dimmable: no

€ 524,00

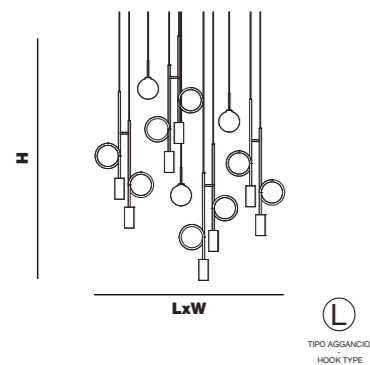

**DOPAMINE PROJECT S8+3**

LxW 110 x 25 cm | 43,30 x 9,84"  
H 140 cm | 55,11"

8 GU10 PAR 16 bulb x max 4W + 3 G9 bulb - 3000°K  
- 220 Vdc Dimmable: no

€ 4.296,00

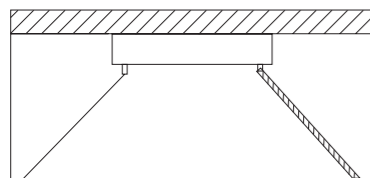

Altezza - Height  
MIN 24 cm - 9,44"



Aggancio con tirante e cavo di alimentazione per sospensioni (E)  
Hook with metal cables and power cord for suspension (E)



Aggancio da definire (L) - Hooks to be defined (L)  
prezzo senza scatola - price without box

# Dopamine

Alexey Danilin

## Particolari - Details

Collezione in acciaio realizzata su disegno. Gli elementi sono curvati a mano da maestri artigiani su sagome. Saldature ad argento. Alcune componenti sono tornite e fresate. DOPAMINE S1 e DOPAMINE s2 hanno come fonte luminosa lampadine GU10 direzionate verso il basso. DOPAMINE project si arricchisce di sospensioni con sfera in borosilicato per illuminare l'intera composizione anche dall'alto. Dopamine è decorata successivamente in colori ral. E' possibile richiedere differenti colorazioni RAL.

Steel collection made to design. The elements are hand bent by master craftsmen on templates. Silver soldering. Some components are turned and milled. DOPAMINE S1 and DOPAMINE s2 have GU10 bulbs directed downwards as a light source. DOPAMINE project is enhanced with borosilicate sphere suspensions to illuminate the entire composition also from above. Dopamine is subsequently decorated in RAL colours. It is possible to request different RAL colours.

## Metalli - Metals

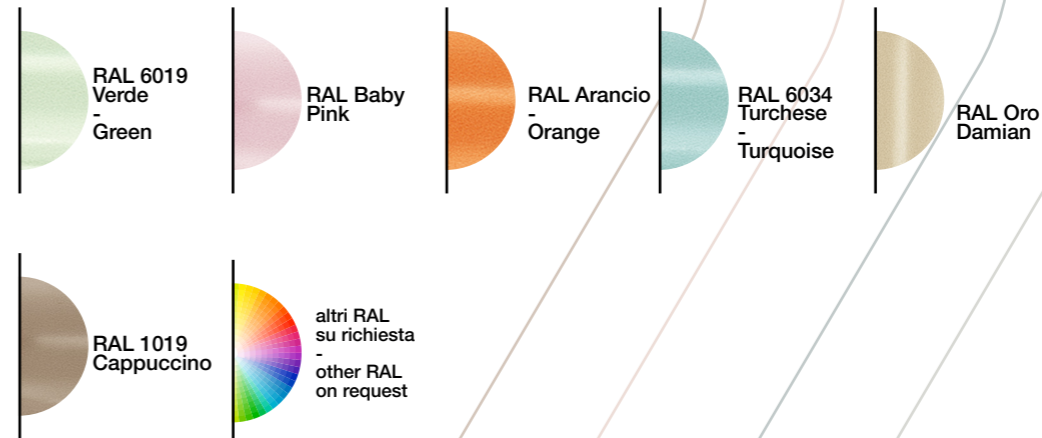

## Color



Bianco latte  
-  
Milk white

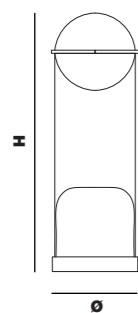

#### THEOREM LAMP

Ø 11 cm | 4,33"  
H 31 cm | 12,20"

1 GU10 PAR 16 bulb x max 6W - 3000°K - 220 Vdc  
Dimmable: no

€ 640,00

# Theorem

Alexey Danilin

## Particolari - Details

Theorem è una collezione che nasce dallo studio della luce e la sua propagazione. La fonte luminosa inserita sulla base riflette su una sfera in borosilicato con doppia decorazione: oro lucido/cromo lucido – bianco latte. Ruotando manualmente la sfera e quindi la destinazione della luce si ottengono propagazioni differenti del fascio di luce. Base in legno tornita su disegno. Legno noce/frassino. Cilindro in vetro borosilicato; Diffusore in PMMA opalino tagliato laser.

Theorem is a collection born from the study of light and its propagation. The light source inserted on the base reflects on a borosilicate sphere with a double decoration: shiny gold/chrome - milk white. By manually rotating the sphere and thus the destination of the light, different propagations of the light beam are obtained. Wooden base turned to design. Walnut/ash wood. Borosilicate glass cylinder; laser-cut opaline PMMA diffuser.

## Metalli - Metals



## Color



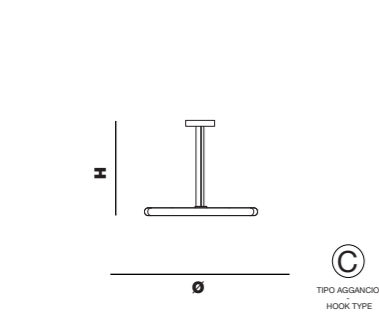

**PEGASO S1**

Ø 66 cm | 25,98"  
H 4 cm | 1,57"

1 striped 40W - 3000°K - 24 Vdc  
5.200 lm - Dimmable: yes

**€ 1.570,00**

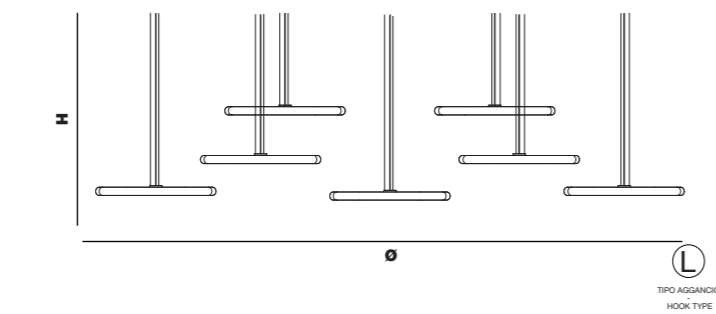

**PEGASO PROJECT S7**

Customisable configuration

**€ 9.680,00**

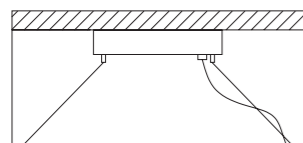

Altezza - Height  
MIN 24 cm - 9.44"

Aggancio con rosone o scatola e tiranti per sospensioni. Altezza regolabile (C)  
Hook with ceiling cup or metal box and metal cables for suspension. Adjustable height (C)



Aggancio da definire (L) - Hooks to be defined (L)  
prezzo senza scatola - price without box

# Pegaso

Cristian Visentin

## Particolari - Details

Pegaso è una collezione interamente made in Italy: strutture in alluminio tornite, curvate a mano da maestri artigiani. Boccole in alluminio tornite e fresate. Vetro cattedrale martellato made in Veneto tagliato a idrogetto su disegno.

Pegaso is a collection entirely made in Italy: turned aluminium structures, hand bent by master craftsmen. Turned and milled aluminium bushings. Hammered cathedral glass made in Veneto water-jet cut to design.

## Metalli - Metals



RAL Bronzo  
brunito  
-  
burnished  
bronze

## Color



Trasparente satinato  
-  
Satin trasparent

\* Specifiche agganci - Info on hooks pag. 16-17 \*

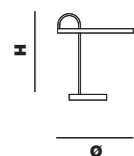

#### NIDO BIG LAMP

Ø 40 cm | 15,78"  
H 46 cm | 18,11"

1 striped 17,6 W - dynamic white - 24 Vdc -  
1947 lm - Dimmable: yes

€ 1.280,00

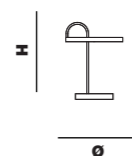

#### NIDO SMALL LAMP

Ø 32 cm | 12,59"  
H 40 cm | 15,74"

1 striped 14 W - dynamic white - 24 Vdc  
1700 lm - Dimmable: yes

€ 980,00

# Nido

Simone Di Liddo

## Particolari - Details

Lampada con componenti in ottone, alluminio, acciaio.

Braccio in ottone curvato manualmente su sagoma con saldature in argento

Anello in alluminio tornito e fresato per alloggiare neonflex, prodotto in Italia

All'interno è inserita una striped dynamic white per scegliere in maniera istantanea la temperatura della luce: da calda a fredda.

\* Per qualsiasi richiesta o differente versione non esitate a contattarci

Lamp with brass, aluminium, steel components.

Manually curved brass arm with silver soldering. Turned and milled aluminium ring to house neonflex, made in Italy. Inside there is a striped dynamic white to instantly choose the temperature of the light: from warm to cold.

\* For any request or different version please contact us

## Metalli - Metals



RAL 6003  
Verde Oliva  
- Olive green



RAL 8011  
Marrone  
metallizzato  
- Metallic brown



RAL 9005  
nero opaco  
- opaque black



altri RAL  
su richiesta  
- other RAL  
on request

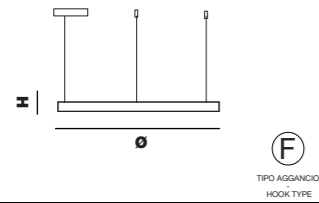

**HENOS 40**

Ø 40 cm | 15,74"  
H 2,3 cm | 0,90"

1 striped 17,6W - 4000°K - 24 Vdc  
2110 lm - - Dimmable: yes

€ 680,00

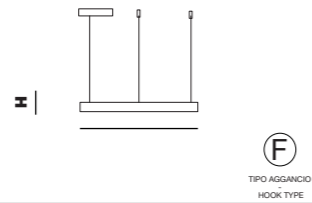

**HENOS 32**

Ø 32 cm | 12,59"  
H 2,3 cm | 0,90"

1 striped 14 W - 4000°K - 24 Vdc -  
1685 lm - Dimmable: yes

€ 570,00

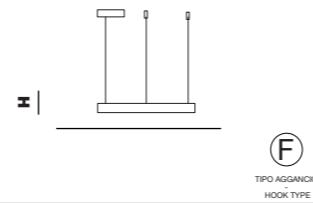

**HENOS 24**

Ø 24 cm | 9,84"  
H 2,3 cm | 0,90"

1 striped 10,6 W - 4000°K - 24 Vdc  
1268 lm - Dimmable: yes

€ 485,00

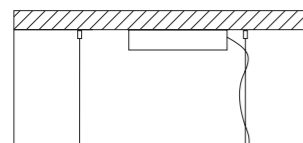

Altezza - Height  
MIN 24 cm - 9.44"



Aggancio con rosone, tiranti e tasselli a soffitto; altezza regolabile (F) - Hook with ceiling cup, metal cables and ceiling cable gripper; adjustable height (F)

# Henos

Michele Losito

## Particolari - Details

Strutture in alluminio prodotte in Italia, tornite e fresate per alloggiare tubo flex luminoso. Disponibile in 3 diversi diametri: diametro 24 cm, diametro 32 cm, diametro 40 cm

\*Per qualsiasi richiesta o differente versione non esitate a contattarci.

Aluminium structures made in Italy, turned and milled to accommodate flex tube lighting. Available in 3 different diameters: diameter 24 cm, diameter 32 cm, diameter 40 cm

\*For any requests or different versions please do not hesitate to contact us.

## Metalli - Metals

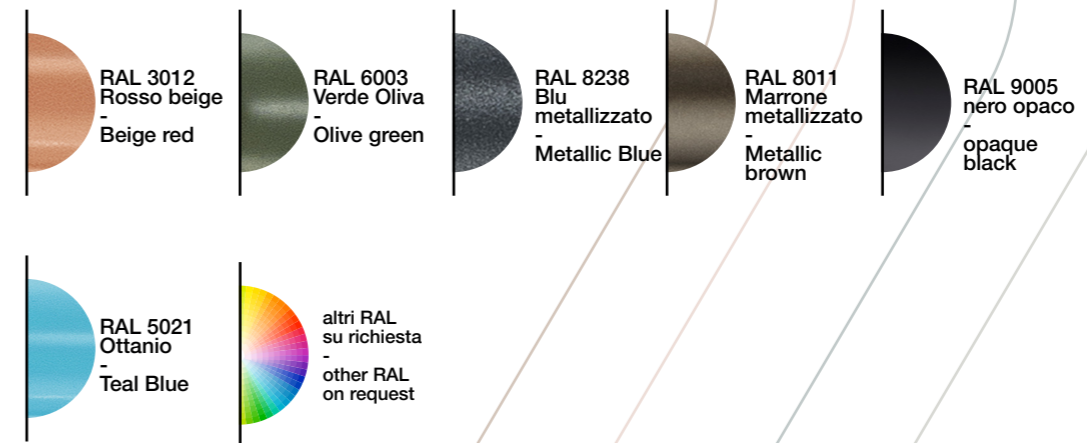

\* Specifiche agganci - Info on hooks pag. 16-17 \*

# Agganci-Hooks

Per le dimensioni dei rosoni e altre specifiche non esitate a contattarci. Se non diversamente richiesto dal cliente, i nostri prodotti vengono forniti con aggancio altezza 150 cm per le tipologie A-D-E-F; con aggancio altezza 70 cm per tipologia B; con aggancio altezza 100 cm per tipologia C; con aggancio altezza 110 cm per tipologia G.

For ceiling cup sizes and other specifications don't hesitate to contact us. Unless otherwise requested by the customer, our products are supplied with 150 cm height hook for types A-D-E-F; with 70 cm height hook for type B; with 100 cm height hook for type C; with 110 cm height hook for type G.

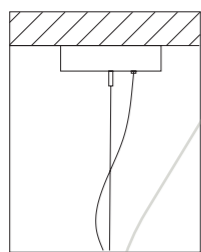

Altezza - Height  
MIN 18 cm - 7.08"

**A** Aggancio con tirante in metallo (A)  
Hook with metal cable (A)

L'altezza dei lampadari è calcolata escludendo l'aggancio. Aggancio con rosone o scatola e filo tirante.  
The height of the chandeliers is calculated by excluding the hook. Hook with the ceiling cup or metal box and cable.

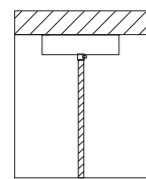

Altezza - Height  
MIN 24 cm - 9.44"

**D** Aggancio con cavo di alimentazione (D)  
Hook with power cord (D)

L'altezza dei lampadari è calcolata escludendo l'aggancio. Aggancio con rosone o scatola a soffitto e cavo di alimentazione.  
The height of the chandeliers is calculated by excluding the hook. Hook with the ceiling cup and power cord.

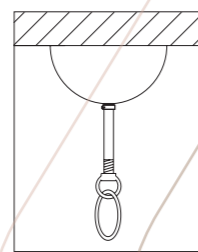

Altezza - Height  
MIN 24 cm - 9.44"

**B** Aggancio con catena (B)  
Hook with chain (B)

L'altezza dei lampadari è calcolata escludendo l'aggancio. Aggancio con rosone e catena.  
The height of the chandeliers is calculated by excluding the hook. Hook with the ceiling cup and chain.

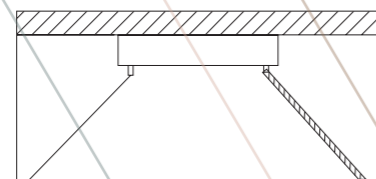

Altezza - Height  
MIN 24 cm - 9.44"

**E** Aggancio con tirante e cavo di alimentazione per sospensioni (E)  
Hook with metal cables and power cord for suspension (E)

L'altezza delle sospensioni è calcolata escludendo l'aggancio. Aggancio con rosone, tirante e cavo di alimentazione.  
The height of suspensions is calculated by excluding the hook. Hook with the ceiling cup, metal cable and power cord.

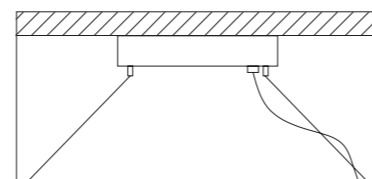

Altezza - Height  
MIN 24 cm - 9.44"

**C** Aggancio con tiranti per sospensioni (C) -  
Hook with metal cables for suspension (C)

L'altezza delle sospensioni è calcolata escludendo l'aggancio. Aggancio con rosone o scatola e tiranti.  
The height of suspensions is calculated by excluding the hook. Hook with the ceiling cup or metal box and metal cables.

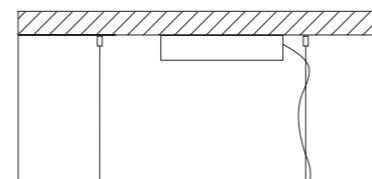

Altezza - Height  
MIN 24 cm - 9.44"

**F** Aggancio con tiranti e tasselli a soffitto (F) -  
Hook with metal cables and ceiling cable gripper (F)

L'altezza delle sospensioni è calcolata escludendo l'aggancio. Aggancio con rosone e tiranti con tasselli a soffitto. The height of suspensions is calculated by excluding the hook. Hook with the ceiling cup and metal cables with ceiling cable gripper.

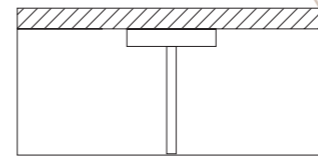

Altezza - Height  
MIN 15 cm - 5.91"

**G** Aggancio altezza fissa (G)  
Hook with fixed height (G)

L'altezza delle sospensioni è calcolata escludendo l'aggancio. Aggancio con rosone e aste cilindriche fisse.  
The height of the suspension is calculated excluding the hook. Hook with ceiling cup and cylindrical rods.

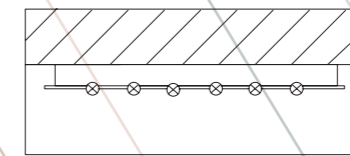

Altezza - Height  
MIN 7 cm - 2.75"

**H** Aggancio con scatola in metallo con luci (H)  
Hook with metallic box with lights (H)

L'altezza dei lampadari è calcolata escludendo l'aggancio. Aggancio con scatola in metallo a soffitto ancorata con staffa. Sulla scatola sono posizionate le luci per illuminare la sospensione.  
The height of the chandeliers is calculated by excluding the hook. Hook with the metal box and the bracket. On the metal box there are the lights to illuminate the suspension.

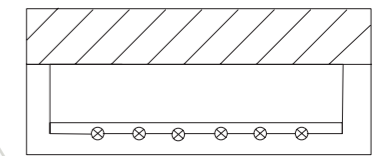

Altezza - Height  
MIN 15 cm - 5.90"

**I** Aggancio con scatola in legno con luci (I)  
Hook with wooden box with lights (I)

L'altezza dei lampadari è calcolata escludendo l'aggancio. Aggancio con scatola in legno a soffitto. Sulla scatola sono posizionate le luci per illuminare la sospensione.  
The height of the chandeliers is calculated by excluding the hook. Hook with the wooden box. On the wooden box there are the lights to illuminate the suspension.

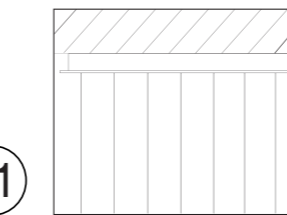

**L1**

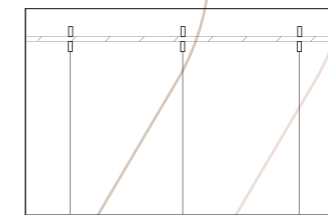

**L2**

**L** Aggancio da definire (L) - Hooks to be defined (L)  
prezzo senza scatola - price without box

\*L'altezza dei lampadari e il relativo prezzo è calcolata escludendo l'aggancio. Per le proposte progettuali è possibile richiedere Aggancio L1: scatola in metallo H MIN 5 cm o in legno H MIN 10 cm, decorati o successivamente verniciabili da ancorare al soffitto con staffa. Aggancio L2: senza scatola; gli elementi prevedono agganci singoli a soffitto. Si richiede la presenza di soffitto in cartongesso.  
\*The height of the chandeliers and their price is calculated excluding the hook. For project proposals it is possible to request Hook L1: metal box H MIN 5 cm or wood H MIN 10 cm, decorated or subsequently paintable to be anchored to the ceiling with bracket. Hook L2: without box; the elements provide individual ceiling hooks. It requires the presence of plasterboard ceiling.

**\* per informazioni specifiche riferirsi alle sezioni relative ai singoli prodotti.**  
**\* for specific information refer to individual product sections.**

**ART DIRECTION/STYLING**  
Studio in Project.

**PHOTO**  
Studio in Project



**Euroluce\_light of Italy**  
76123 Andria (BT) Italy  
t +39 0883 559385  
[www.eurolucelampadari.it](http://www.eurolucelampadari.it)  
[info@eurolucelampadari.it](mailto:info@eurolucelampadari.it)

-  
Euroluce\_light of Italy is  
a registered trademark.

euroluce  
— LIGHT OF ITALY —