

Caos creativo[®]

HUMAN DESIGN EXPERIENCE

LISTINO AL PUBBLICO FEBBRAIO 2025
RETAIL PRICE LIST FEBRUARY 2025

LIBRERIA ALL-OVER
ALL-OVER BOOKCASE

CONTENUTI INDEX

MODULARITÀ MODULARITY	02
MENSOLE, DISTANZIALI E PORTA BICCHIERI SHELVES, SPACERS AND STEMWARE RACKS	04
ELEMENTI DI PARTENZA E SOVRAPPOSIZIONE INITIAL MODULES AND ADDITIONAL MODULES	06
COMPOSIZIONI PORTA BICCHIERI / BOTTIGLIE STEMWARE RACK AND BOTTLE RACK CONFIGURATIONS	08
COMPOSIZIONI A CATALOGO CATALOGUE ARRANGEMENTS	10
INFORMAZIONI TECNICHE - FINITURE TECHNICAL INFORMATION - FINISHES	18
CONDIZIONI DI VENDITA TERMS OF SALE	20

Tutti i prezzi si intendono al pubblico IVA esclusa, espressi in euro, comprensivi di trasporto (per Italia) / ex works (per estero). I prezzi per minimo fatturabile e spedizione sono netti IVA esclusa, espressi in Euro. Le misure sono espresse in cm.

MINIMO FATTURABILE

Minimo fatturabile imponibile netto IVA esclusa pari a €150

COSTI DI SPEDIZIONE

Per l'Italia: agli ordini con importo imponibile netto, IVA esclusa, inferiori a €250, saranno applicate spese di spedizione extra pari a € 25 netto + IVA.

Per l'estero: i prezzi si intendono ex works ai quali vanno applicate spese di spedizione extra pari a €45 netto.

Costi di trasporto validi per i seguenti paesi:

Germania, Austria, Svizzera, Lussemburgo, Francia, Polonia, Repubblica Ceca, Slovacchia, Spagna, Ungheria, Slovenia, Romania, Bulgaria.

All prices are retail, in Euro and excluding VAT. They are inclusive of shipping (in Italy) and ex works (for abroad). Minimum billable amount and shipping costs are net, without VAT and in Euro. Measurements are in cm.

MINIMUM BILLABLE AMOUNT

Minimum taxable invoice amount excluding VAT is €150 net

SHIPPING COSTS

For Italy: for orders with a net taxable amount (excluding VAT) less than €250, additional shipping costs of €25 net + VAT will be applied.

For abroad: prices are ex works, and additional shipping costs of €45 net will be applied.

Transport costs valid in the following countries:

Germany, Austria, Switzerland, Luxembourg, France, Poland, Czech Republic, Slovakia, Spain, Hungary, Slovenia, Romania, Bulgaria.

MODULARITÀ / MODULARITY



Antracite goffrato (RAL 9005)
Embossed anthracite (RAL 9005)

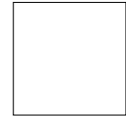

Bianco goffrato (RAL 9003)
Embossed white (RAL 9003)



Bronzo liscio
Plain bronze

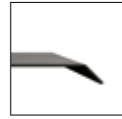

Spessore mensola (lamiera) 12 mm
Thickness of sheet metal shelf: 12 mm

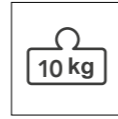

Kg per vano (interasse distanziali) uniformemente distribuiti.
Kg evenly distributed in each compartment (i.e. space between spacers).

MENSOLE L 38 (1 vano / 2 distanziali)

SHELVES L 38 (1 compartment / 2 spacers)

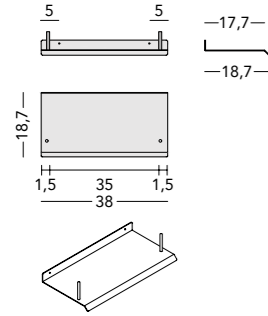

MENSOLE L 73 (2 vani / 3 distanziali)

SHELVES L 73 (2 compartments / 3 spacers)

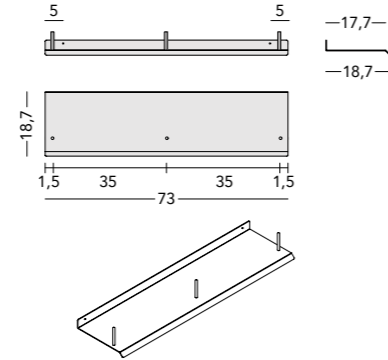

MENSOLE L 108 (3 vani / 4 distanziali)

SHELVES L 108 (3 compartments / 4 spacers)

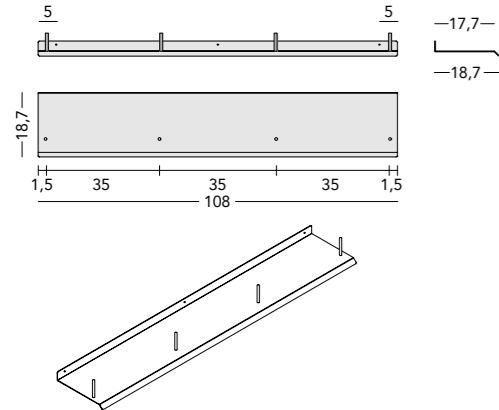

MENSOLE L 143 (4 vani / 5 distanziali)

SHELVES L 143 (4 compartments / 5 spacers)

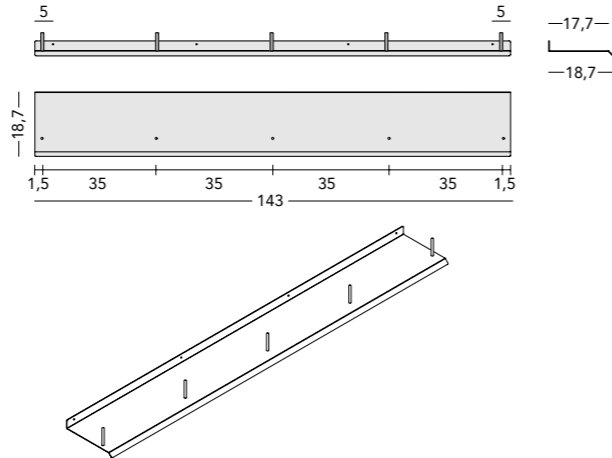

MENSOLE L 178 (5 vani / 6 distanziali)

SHELVES L 178 (5 compartments / 6 spacers)

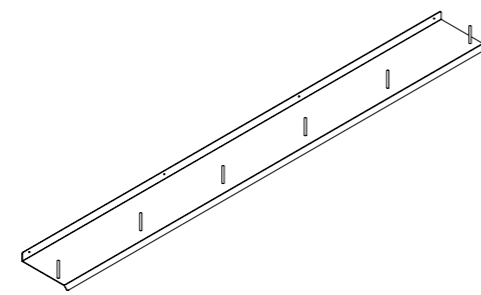
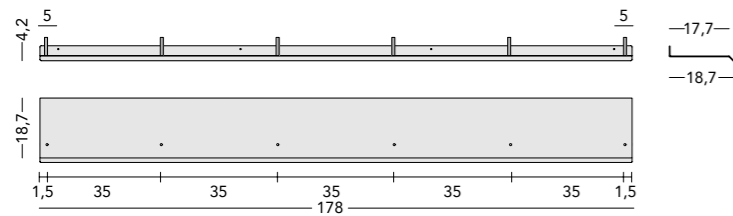

MODULARITÀ / MODULARITY



Antracite goffrato (RAL 9005)
Embossed anthracite (RAL 9005)

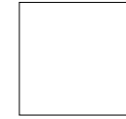

Bianco goffrato (RAL 9003)
Embossed white (RAL 9003)



Bronzo liscio
Plain bronze

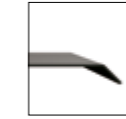

Spessore mensola (lamiera) 12 mm
Thickness of sheet metal shelf: 12 mm

PORTA BICCHIERI L 38 (1 vano / 2 distanziali) H 4,8

STEMWARE RACK L 38 (1 compartment / 2 spacers) H 4.8

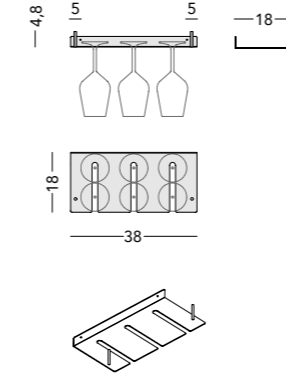

PORTA BICCHIERI L 73 (2 vani / 3 distanziali) H 4,8

STEMWARE RACK L 73 (2 compartments / 3 spacers) H 4.8

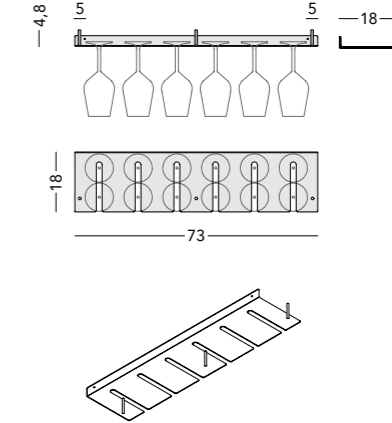

Vista in pianta porta bicchieri

Top view of stemware rack

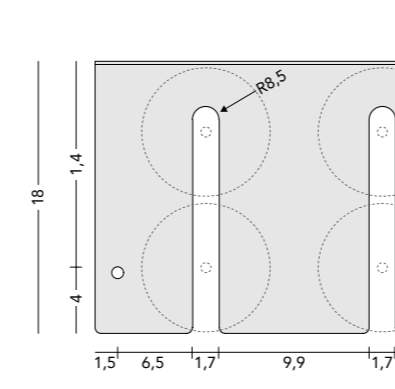

Vista frontale porta bicchieri

Front view of stemware rack

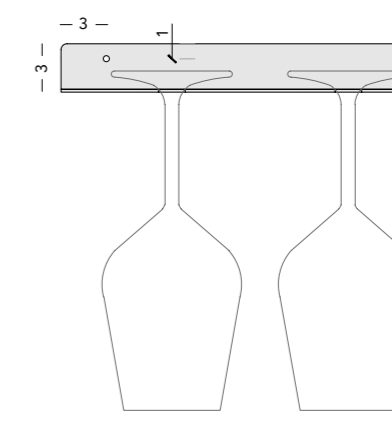

Vista in pianta mensola

Top view of shelf

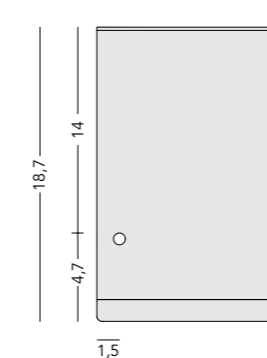

DISTANZIALI Ø 0,8

SPACERS Ø 0.8

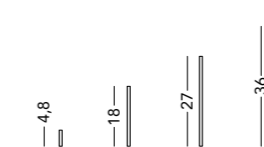

FISSAGGIO DISTANZIALI ALLE MENSOLE

FIXING THE SPACERS TO THE SHELVES

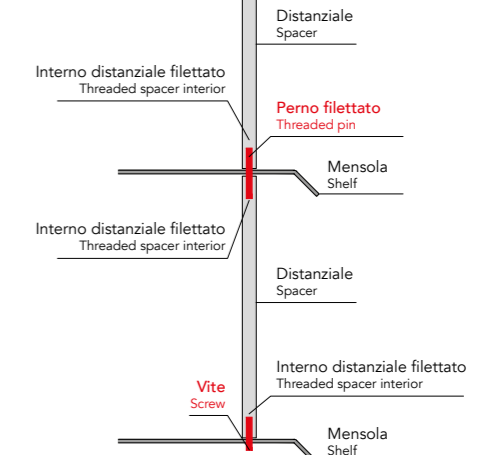

MENSOLE E DISTANZIALI / SHELVES AND SPACERS



Antracite goffrato (RAL 9005)
Embossed anthracite (RAL 9005)

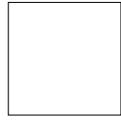

Bianco goffrato (RAL 9003)
Embossed white (RAL 9003)



Bronzo liscio
Plain bronze

MENSOLE H 4,5 SHELVES H 4.5

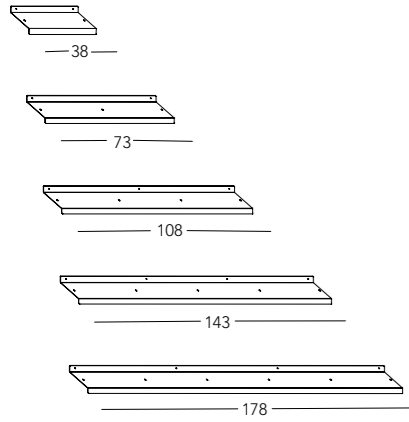

	L 38	L 73	L 108	L 143	L 178
	1 vano / 2 distanziali 1 compartment / 2 spacers	2 vani / 3 distanziali 2 compartments / 3 spacers	3 vani / 4 distanziali 3 compartments / 4 spacers	4 vani / 5 distanziali 4 compartments / 5 spacers	5 vani / 6 distanziali 5 compartments / 6 spacers
Laccato antracite Anthracite lacquer	R0012 36	R0022 55	R0032 76	R0042 98	R0052 117
Laccato bianco White lacquer	R0011 36	R0021 55	R0031 76	R0041 98	R0051 117
Laccato bronzo Bronze lacquer	R0013 36	R0023 55	R0033 76	R0043 98	R0053 117

N.B. La mensola deve sempre avere il distanziale iniziale e terminale
A shelf must always have an initial and end spacer

DISTANZIALI Ø 0,8 Spacers Ø 0.8

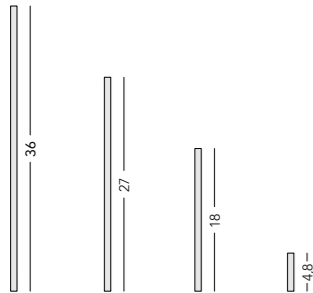

	H 4,8	H 18	H 27	H 36
	Solo per porta bicchieri For stemware rack only			
Laccato antracite Anthracite lacquer	R0212 10	R0222 10	R0232 12	R0242 12
Laccato bianco White lacquer	R0211 10	R0221 10	R0231 12	R0241 12
Laccato bronzo Bronze lacquer	R0213 10	R0223 10	R0233 12	R0243 12

PORTA BICCHIERI / STEMWARE RACK



Antracite goffrato (RAL 9005)
Embossed anthracite (RAL 9005)

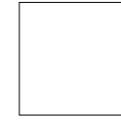

Bianco goffrato (RAL 9003)
Embossed white (RAL 9003)



Bronzo liscio
Plain bronze

PORTA BICCHIERI L 38 COMPRESIVI DI DISTANZIALI H 4,8 STEMWARE RACK L 38 INCLUDING SPACERS H 4.8

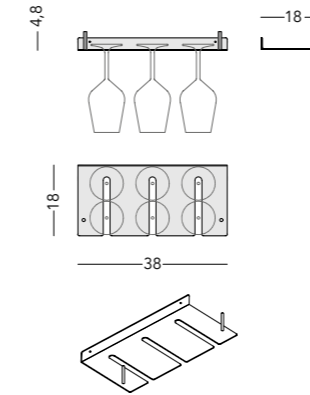

	L 38
	1 vano 1 compartment
PORTA BICCHIERI da 6 bicchieri Stemware rack – holds 6 glasses	R0312 79
	R0311 79
	R0313 79

PORTA BICCHIERI L 73 COMPRESIVI DI DISTANZIALI H 4,8 STEMWARE RACK L 73 INCLUDING SPACERS H 4.8

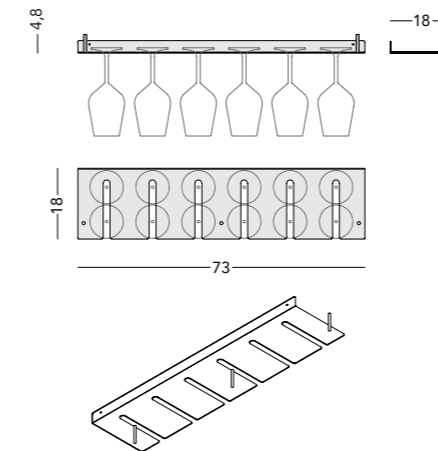

	L 73
	2 vani 2 compartments
PORTA BICCHIERI da 12 bicchieri Stemware rack – holds 12 glasses	R0322 117
	R0321 117
	R0323 117

ELEMENTI DI PARTENZA / INITIAL MODULES





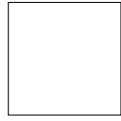

Antracite goffrato (RAL 9005)
Embossed anthracite (RAL 9005)







Bianco goffrato (RAL 9003)
Embossed white (RAL 9003)



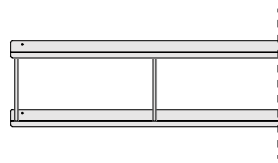

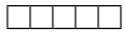

Bronzo liscio
Plain bronze

						
		L 38	L 73	L 108	L 143	L 178
		1 vano 1 compartment	2 vani 2 compartments	3 vani 3 compartments	4 vani 4 compartments	5 vani 5 compartments
ELEMENTO 2 MENSOLE H 22,3 con distanziali H 18 Module with 2 shelves H 22.3 with spacers H 18	Laccato antracite Anthracite lacquer	R0712	R0722	R0732	R0742	R0752
		92	140	192	246	294
	Laccato bianco White lacquer	R0711	R0721	R0731	R0741	R0751
	92	140	192	246	294	
	Laccato bronzo Bronze lacquer	R0713	R0723	R0733	R0743	R0753
	92	140	192	246	294	

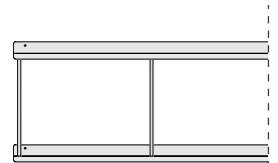

						
		L 38	L 73	L 108	L 143	L 178
		1 vano 1 compartment	2 vani 2 compartments	3 vani 3 compartments	4 vani 4 compartments	5 vani 5 compartments
ELEMENTO 2 MENSOLE H 31,3 con distanziali H 27 Module with 2 shelves H 31.3 with spacers H 27	Laccato antracite Anthracite lacquer	R0812	R0822	R0832	R0842	R0852
		96	146	200	256	306
	Laccato bianco White lacquer	R0811	R0821	R0831	R0841	R0851
	96	146	200	256	306	
	Laccato bronzo Bronze lacquer	R0813	R0823	R0833	R0843	R0853
	96	146	200	256	306	

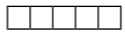

						
		L 38	L 73	L 108	L 143	L 178
		1 vano 1 compartment	2 vani 2 compartments	3 vani 3 compartments	4 vani 4 compartments	5 vani 5 compartments
ELEMENTO 2 MENSOLE H 40,3 con distanziali H 36 Module with 2 shelves H 40.3 with spacers H 36	Laccato antracite Anthracite lacquer	R0912	R0922	R0932	R0942	R0952
		96	146	200	256	306
	Laccato bianco White lacquer	R0911	R0921	R0931	R0941	R0951
	96	146	200	256	306	
	Laccato bronzo Bronze lacquer	R0913	R0923	R0933	R0943	R0953
	96	146	200	256	306	

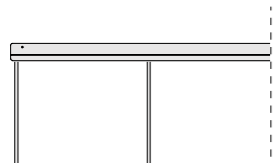

ELEMENTI IN SOVRAPPOSIZIONE / ADDITIONAL MODULES







Antracite goffrato (RAL 9005)
Embossed anthracite (RAL 9005)









Bianco goffrato (RAL 9003)
Embossed white (RAL 9003)

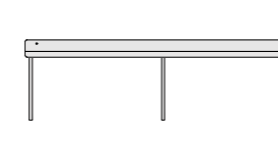





Bronzo liscio
Plain bronze

						
		L 38	L 73	L 108	L 143	L 178
		1 vano 1 compartment	2 vani 2 compartments	3 vani 3 compartments	4 vani 4 compartments	5 vani 5 compartments
ELEMENTO H 21,2 con distanziali H 18 MODULE H 21.2 with spacers H 18	Laccato antracite Anthracite lacquer	R0412	R0422	R0432	R0442	R0452
		56	85	116	148	177
	Laccato bianco White lacquer	R0411	R0421	R0431	R0441	R0451
	56	85	116	148	177	
	Laccato bronzo Bronze lacquer	R0413	R0423	R0433	R0443	R0453
	56	85	116	148	177	

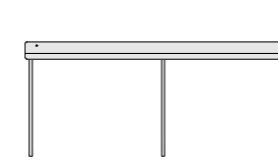

						
		L 38	L 73	L 108	L 143	L 178
		1 vano 1 compartment	2 vani 2 compartments	3 vani 3 compartments	4 vani 4 compartments	5 vani 5 compartments
ELEMENTO H 30,2 con distanziali H 27 MODULE H 30.2 with spacers H 27	Laccato antracite Anthracite lacquer	R0512	R0522	R0532	R0542	R0552
		60	91	124	158	189
	Laccato bianco White lacquer	R0511	R0521	R0531	R0541	R0551
	60	91	124	158	189	
	Laccato bronzo Bronze lacquer	R0513	R0523	R0533	R0543	R0553
	60	91	124	158	189	

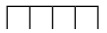
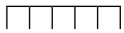

						
		L 38	L 73	L 108	L 143	L 178
		1 vano 1 compartment	2 vani 2 compartments	3 vani 3 compartments	4 vani 4 compartments	5 vani 5 compartments
ELEMENTO H 39,2 con distanziali H 36 MODULE H 39.2 with spacers H 36	Laccato antracite Anthracite lacquer	R0612	R0622	R0632	R0642	R0652
		60	91	124	158	189
	Laccato bianco White lacquer	R0611	R0621	R0631	R0641	R0651
	60	91	124	158	189	
	Laccato bronzo Bronze lacquer	R0613	R0623	R0633	R0643	R0653
	60	91	124	158	189	

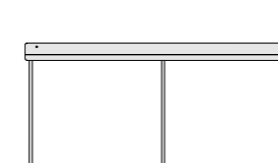

COMPOSIZIONI PORTA BICCHIERI / BOTTIGLIE / STEMWARE / BOTTLE RACK CONFIGURATION



Antracite goffrato (RAL 9005)
Embossed anthracite (RAL 9005)



Bianco goffrato (RAL 9003)
Embossed white (RAL 9003)



Bronzo liscio
Plain bronze

COMPOSIZIONE PORTA BICCHIERI / BOTTIGLIE H 45,2 1 VANO STEMWARE / BOTTLE RACK CONFIGURATION H 45.2 - 1 COMPARTMENT

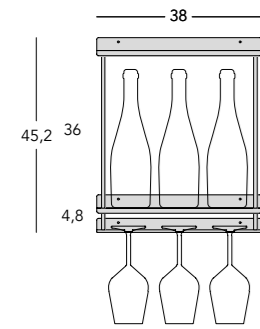

L 38

1 vano
1 compartment

Laccato antracite Anthracite lacquer	R0112 175
Laccato bianco White lacquer	R0111 175
Laccato bronzo Bronze lacquer	R0113 175

COMPOSIZIONI PORTA BICCHIERI / BOTTIGLIE / STEMWARE / BOTTLE RACK CONFIGURATION



Antracite goffrato (RAL 9005)
Embossed anthracite (RAL 9005)

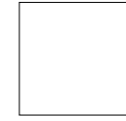

Bianco goffrato (RAL 9003)
Embossed white (RAL 9003)



Bronzo liscio
Plain bronze

COMPOSIZIONE PORTA BICCHIERI / BOTTIGLIE H 63,4 1 VANO STEMWARE / BOTTLE RACK CONFIGURATION H 63.4 - 1 COMPARTMENT

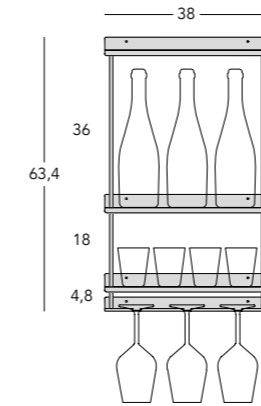

L 38

1 vano
1 compartment

Laccato antracite Anthracite lacquer	R0152 231
Laccato bianco White lacquer	R0151 231
Laccato bronzo Bronze lacquer	R0153 231

COMPOSIZIONE PORTA BICCHIERI / BOTTIGLIE H 45,2 2 VANI STEMWARE / BOTTLE RACK CONFIGURATION H 45.2 - 2 COMPARTMENTS

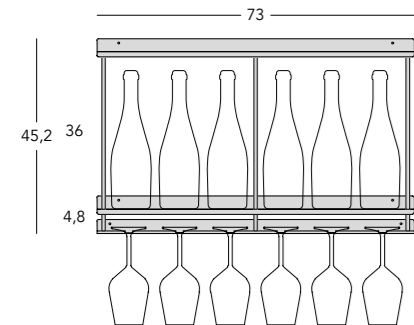

L 73

2 vani
2 compartments

Laccato antracite Anthracite lacquer	R0122 263
Laccato bianco White lacquer	R0121 263
Laccato bronzo Bronze lacquer	R0123 263

COMPOSIZIONE PORTA BICCHIERI / BOTTIGLIE H 63,4 2 VANI STEMWARE / BOTTLE RACK CONFIGURATION H 63.4 - 2 COMPARTMENTS

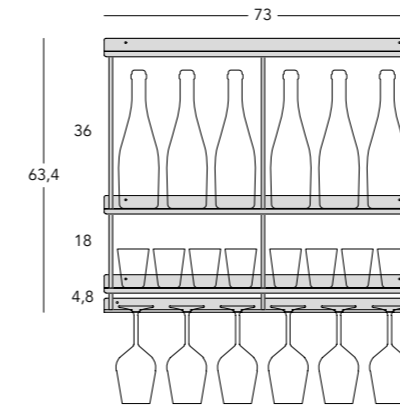

L 73

2 vani
2 compartments

Laccato antracite Anthracite lacquer	R0162 348
Laccato bianco White lacquer	R0161 348
Laccato bronzo Bronze lacquer	R0163 348

COMPOSIZIONI A CATALOGO / CATALOGUE ARRANGEMENTS



COMP. **01** Laccato antracite/bianco/bronzo € 924
 L. 248 P. 18,7 H. 121,8
 Anthracite lacquer/White/Bronze

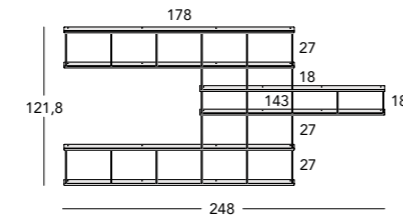

COMP. **02** Laccato antracite/bianco/bronzo € 1.541
 L. 178 P. 18,7 H. 221,2
 Anthracite lacquer/White/Bronze

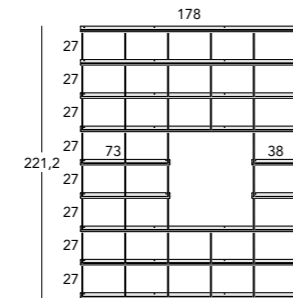

COMP. **03** Laccato antracite/bianco/bronzo € 294
 L. 178 P. 18,7 H. 22,3
 Anthracite lacquer/White/Bronze



COMP. **04** Laccato antracite/bianco/bronzo € 1.256
 L. 321 P. 18,7 H. 85,6
 Anthracite lacquer/White/Bronze

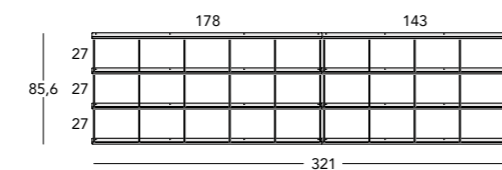

COMPOSIZIONI A CATALOGO / CATALOGUE ARRANGEMENTS



COMP. **05** Laccato antracite/bianco/bronzo € 804
 L. 108 P. 18,7 H. 148,9
 Anthracite lacquer/White/Bronze

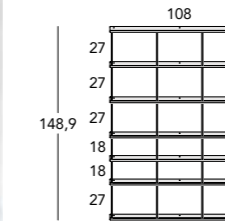

COMP. **06** Laccato antracite/bianco/bronzo € 1.459
 L. 143 P. 18,7 H. 212,3
 Anthracite lacquer/White/Bronze

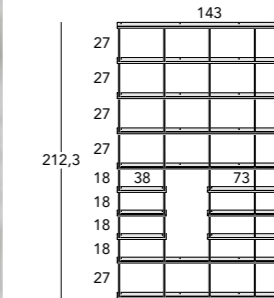

COMP. **07** Laccato antracite/bianco/bronzo € 1.362
 L. 143 P. 18,7 H. 212,3
 Anthracite lacquer/White/Bronze

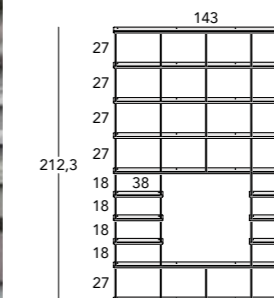

COMP. **08** Laccato antracite/bianco/bronzo € 873
 L. 178 P. 18,7 H. 112,7
 Anthracite lacquer/White/Bronze

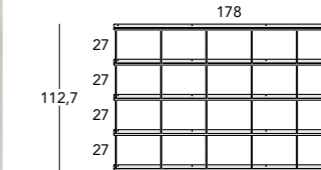

COMPOSIZIONI A CATALOGO / CATALOGUE ARRANGEMENTS



COMP. **19** Laccato antracite/bianco/bronzo € 688
 L. 108 P. 18,7 H. 130,8
 Anthracite lacquer/White/Bronze

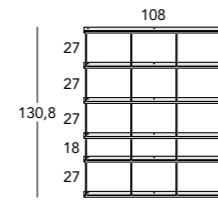

COMP. **20** Laccato antracite/bianco/bronzo € 1.500
 L. 146 P. 18,7 H. 180,9
 Anthracite lacquer/White/Bronze

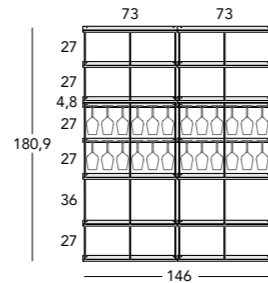

COMP. **21** Laccato antracite/bianco/bronzo € 1.472
 L. 388 P. 18,7 H. 77,3
 Anthracite lacquer/White/Bronze

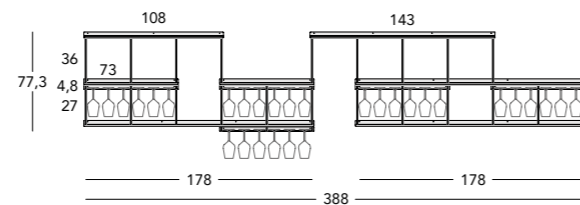

COMP. **22** Laccato antracite/bianco/bronzo € 869
 L. 248 P. 18,7 H. 54,4
 Anthracite lacquer/White/Bronze

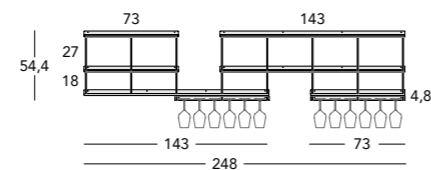

COMPOSIZIONI A CATALOGO / CATALOGUE ARRANGEMENTS



COMP. **23** Laccato antracite/bianco/bronzo € 636
 L. 283 P. 18,7 H. 76,7
 Anthracite lacquer/White/Bronze

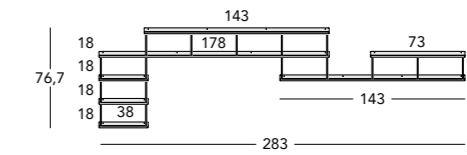

COMP. **24** Laccato antracite/bianco/bronzo € 735
 L. 219 P. 18,7 H. 58,4
 Anthracite lacquer/White/Bronze

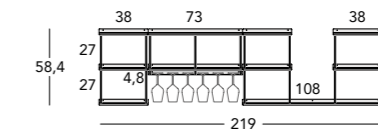

COMP. **25** Laccato antracite/bianco/bronzo € 1.629
 L. 178 P. 18,7 H. 221,2
 Anthracite lacquer/White/Bronze

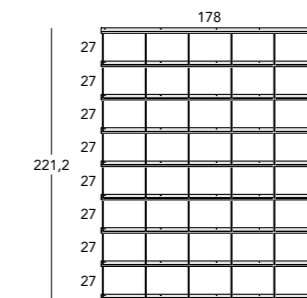

COMP. **26** Laccato antracite/bianco/bronzo € 488
 L. 178 P. 18,7 H. 85,6
 Anthracite lacquer/White/Bronze

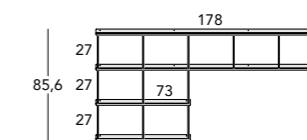

COMPOSIZIONI A CATALOGO / CATALOGUE ARRANGEMENTS



COMP. **27** Laccato antracite/bianco/bronzo € 420
 L. 178 P. 18,7 H. 76,6
 Anthracite lacquer/White/Bronze

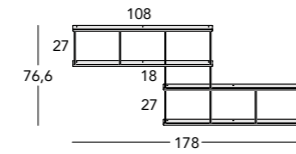

COMP. **28** Laccato antracite/bianco/bronzo € 419
 L. 73 P. 18,7 H. 112,7
 Anthracite lacquer/White/Bronze

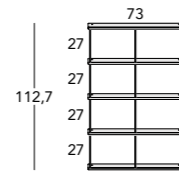

COMP. **29** Laccato antracite/bianco/bronzo € 417
 L. 178 P. 18,7 H. 76,6
 Anthracite lacquer/White/Bronze

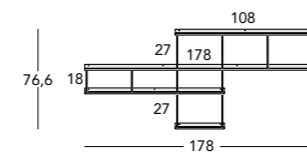

COMP. **30** Laccato antracite/bianco/bronzo € 448
 L. 108 P. 18,7 H. 85,6
 Anthracite lacquer/White/Bronze

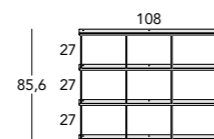

COMPOSIZIONI A CATALOGO / CATALOGUE ARRANGEMENTS



COMP. **31** Laccato antracite/bianco/bronzo € 1.826
 L. 147 P. 18,7 H. 293,6
 Anthracite lacquer/White/Bronze

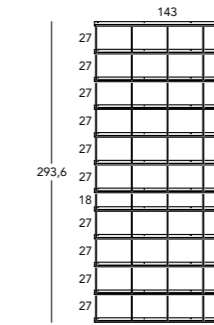

COMP. **32** Laccato antracite/bianco/bronzo € 1.368
 L. 356 P. 18,7 H. 85,6
 Anthracite lacquer/White/Bronze

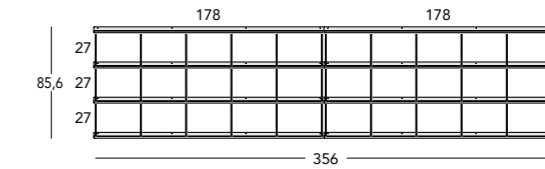

CONDIZIONI DI VENDITA

Il presente listino entra in vigore da Febbraio 2025.

ORDINAZIONE

Tutti i prezzi si intendono al pubblico IVA esclusa, espressi in euro, comprensivi di trasporto (per Italia) / ex works (per estero). I prezzi per minimo fatturabile e spedizione sono netti IVA esclusa, espressi in Euro. Le misure sono espresse in cm.

MINIMO FATTURABILE

Minimo fatturabile imponibile netto IVA esclusa pari a €150

COSTI DI SPEDIZIONE

Per l'Italia: agli ordini con importo imponibile netto, IVA esclusa, inferiori a €250, saranno applicate spese di spedizione extra pari a € 25 netto + IVA.

Per l'estero: i prezzi si intendono ex works ai quali vanno applicate spese di spedizione extra pari a €45 netto.

Costi di trasporto validi per i seguenti paesi:

Germania, Austria, Svizzera, Lussembourgo, Francia, Polonia, Repubblica Ceca, Slovacchia, Spagna, Ungheria, Slovenia, Romania, Bulgaria.

CONSEGNA

I termini di consegna non sono impegnativi ma solo indicativi e possono subire ritardi che comunque non danno diritto ad indennizzi di alcun genere.

PREZZI

I prezzi sono quelli indicati nel listino in vigore più l'IVA. Deroghe alle condizioni di vendita dovranno essere preventivamente concordate per iscritto con la Rossi&Co. s.r.l.

PAGAMENTI

I pagamenti dovranno essere effettuati direttamente alla Rossi&Co. s.r.l. Il mancato pagamento alla scadenza pattuita anche di una sola fattura o rata, dà diritto a Rossi&Co. di sospendere eventuali consegne ed annullare ordini, anche se confermati.

RECLAMI

Eventuali reclami riguardanti la quantità e/o la qualità della merce fornita devono pervenire a mezzo raccomandata alla Rossi&Co. s.r.l. entro 8 giorni dal ricevimento della merce.

Non si accetta merce in restituzione senza la preventiva autorizzazione della Rossi&Co. s.r.l.; le spese di trasporto sono sempre a carico del committente; se la stessa dovesse essere resa in non perfetto stato, la valutazione dell'accredito corrisponderà al valore eventualmente recuperabile.

PRODUZIONE

La riproduzione dei colori delle immagini grafiche contenute nei cataloghi e/o visualizzate a monitor, è indicativa rispetto la resa cromatica reale sul supporto stampato. Minime differenze non sono considerate difetto.

La ditta Rossi&Co. s.r.l. declina ogni responsabilità per danni derivanti da errato montaggio dei prodotti forniti, ovvero, da difettosa installazione e/o utilizzo di collanti, fissativi o vernici non di propria produzione e facente parte dei prodotti stessi.

FORO COMPETENTE

Per ogni controversia è applicabile la Legge italiana; Foro competente è quello di Pordenone (Italia).

IL PRESENTE LISTINO SOSTITUISCE ED ANNULLA I PRECEDENTI.

TERMS OF SALE

This price list comes into force in February 2025.

ORDERS

All prices are retail, in Euro and excluding VAT. They are inclusive of shipping (in Italy) and ex works (for abroad). Minimum billable amount and shipping costs are net, without VAT and in Euro. Measurements are in cm.

MINIMUM BILLABLE AMOUNT

Minimum taxable invoice amount excluding VAT is €150 net

SHIPPING COSTS

For Italy: for orders with a net taxable amount (excluding VAT) less than €250, additional shipping costs of €25 net + VAT will be applied.

For abroad: prices are ex works, and additional shipping costs of €45 net will be applied.

Transport costs valid in the following countries:

Germany, Austria, Switzerland, Luxembourg, France, Poland, Czech Republic, Slovakia, Spain, Hungary, Slovenia, Romania, Bulgaria.

DELIVERY LEAD TIMES

Delivery lead times are purely indicative and non-binding. Any delays do not qualify the customer for compensation of any kind.

PRICES

Prices are those indicated in the price list in force, plus VAT. Any exceptions to these Terms of Sale must be agreed in writing with Rossi&Co. s.r.l. in advance.

PAYMENTS

Payments must be made directly to Rossi&Co. s.r.l. Lack of payment at the due date of even one invoice or instalment will entitle Rossi&Co. to stop deliveries and to cancels orders, including any already confirmed.

COMPLAINTS

Any complaints concerning the quantity and/or quality of the goods supplied must reach Rossi&Co. s.r.l. by registered mail within 8 days from receiving them. Returns will not be accepted unless authorised in advance by Rossi&Co. s.r.l. Transport fees will always be borne by Rossi&Co; if the condition of the returned goods is less than perfect, the refund will correspond to the recoverable value, if any.

PRODUCTION

Colour reproductions of graphic images shown in catalogues and /or on your screen are merely indicative of the actual colours used on the printed substrate. Small differences cannot be regarded as defects.

Rossi&Co. s.r.l. will not be held responsible, under any circumstance, for damage deriving from wrong installation/hanging of the products supplied and/or for the wrong use of pastes, fixing agents or varnishes not manufactured by the seller but which, nevertheless, come with the goods.

COURT OF JURISDICTION

The Italian law will be applied to settle any disputes which will be resolved under the exclusive jurisdiction of the Law Court of Pordenone (Italy).

THIS PRICE LIST REPLACES AND CANCELS ALL PRECEDING ONES.

VERKAUFSBEDINGUNGEN

Diese Preisliste tritt ab Februar 2025 in Kraft

BESTELLUNG

Alle Preiseangaben sind in Euro angeben, ohne Mehrwertsteuer (inklusive Transport in Italien) und Abwerk im Ausland.

Die Preise von Mindestbestellwert und Transportkosten sind Netto, ohne Mehrwertsteuer.

Die Abmessungen verstehen sich in cm.

MINDESTBESTELLWERT

Mindestbestellwert Netto, ohne Mehrwersteuer beträgt 150 Euro

VERSANDKOSTEN

Italien: für Bestellungen mit einem Nettobetrag von weniger als 250 Euro ohne Mehrwertsteuer werden Versandkosten in Höhe von 25 Euro Netto + Mehrwertsteuer berechnet.

Für den Export: Die Preise verstehen sich ab Werk, zuzüglich Versandkosten in Höhe von 45 Euro Netto.

Diese Versandkosten gelten für folgende Länder:

Deutschland, Österreich, Schweiz, Luxemburg, Frankreich, Spanien, Polen, Tschechische Republik, Slowakei, Ungarn, Slowenien, Rumänien, Bulgarien.

LIEFERUNG

Die Lieferfristen sind informative Richtwerte und nicht bindend. Eventuelle Verzögerungen begründen kein Recht auf Entschädigung irgendeiner Art.

PREISE

Die Preise sind die in der aktuellen, derzeit gültigen Preisliste aufgeführten Preisangaben zuzüglich Mwst. Ausnahmen von den Verkaufsbedingungen müssen vorab schriftlich mit Rossi&Co. s.r.l. vereinbart werden.

BEZAHLUNGEN

Die Zahlungen sind direkt an Rossi&Co. s.r.l. zu leisten. Bei Nichtzahlung zum vereinbarten Fälligkeitsdatum hat Rossi&Co. das Recht, eventuelle Lieferungen auszusetzen und Aufträge zu stornieren. Dabei ist es irrelevant, ob es sich um eine einzelne Rechnung oder um eine Rate handelt und dies gilt auch, wenn die Bestellung bereits bestätigt wurde.

REKLAMATIONEN

Eventuelle Reklamationen, welche die Menge und/oder Qualität der gelieferten Ware betreffen, sind innerhalb von 8 Tagen nach Erhalt der Ware per Einschreiben an Rossi&Co. s.r.l. zu richten.

Rücksendungen werden ohne vorherige Genehmigung von Rossi&Co. s.r.l. nicht angenommen. Die Rücksendekosten gehen immer zu Lasten des Kunden, falls die Ware nicht in einwandfreiem Zustand zurückgeschickt wird. Die Höhe der Gutschrift richtet sich nach dem Wert, der möglicherweise noch mit der Ware erzielt werden kann.

HERSTELLUNG

Die Farbdarstellung auf den grafischen Abbildungen in den Katalogen und/oder auf dem Bildschirm kann die tatsächliche Farbwirkung nur eingeschränkt wiedergeben. Minimale Unterschiede werden nicht als Mangel angesehen.

Rossi&Co. s.r.l. lehnt jede Verantwortung und Haftung für Schäden ab, die sich aus einem fehlerhaften Anbringen der gelieferten Produkte ergeben. Dies schließt eine falsche Verarbeitung bzw. Verwendung der Ware ein und/oder den Einsatz von Kleister, Kleber, Fixiermittel oder Lacken, die nicht aus der eigenen Produktion stammen und/oder Teil der Ware selbst sind.

GERICHTSSTAND

Alle Streitigkeiten unterliegen dem italienischen Recht. Gerichtsstand ist Pordenone (Italien).

DIE VORLIEGENDE PREISLISTE ERSETZT ALLE BISHERIGEN PREISLISTEN, DIE DAMIT IHRE GÜLTIGKEIT VERLIEREN.

contact

ordini.wall@caoscreativo.it

Tel. +39 0445 1654438



caoscreativo.it

Caos creativo
è un marchio registrato
di proprietà di Rossi&Co. s.r.l.
The **Caos Creativo** trademark
belongs to Rossi&Co. s.r.l.

Ufficio commerciale e ordini
Sales and orders department
via Astico, 40
36030 Fara Vicentino (VI)
t. +39 0445 1654438

Sede Legale
Registered office
Via Bassano del Grappa,3
36030 Sarcedo (VI)

C.F. e P.IVA 03991950241
Tax code and VAT nr. 03991950241
rossieco@pec.it